



KONICA MINOLTA

The essentials of imaging



bizhub C652/C652DS/C552/C452

User's Guide
Box Operations



Table of contents

1 Introduction

1.1	Welcome	1-3
1.1.1	User's guides	1-3
1.1.2	User's Guide	1-4
1.2	Conventions used in this manual	1-5
1.2.1	Symbols used in this manual	1-5
	To use this machine safely.....	1-5
	Procedural instruction.....	1-5
	Key symbols.....	1-6
1.2.2	Original and paper indications	1-6
	Original and paper sizes	1-6
	Original and paper indication.....	1-6
1.3	To check the function you want to use.....	1-7
	Understanding Operation Flow	1-7
	Using Menu Tree.....	1-7

2 User Box Function Overview

2.1	User Box functions	2-3
2.1.1	Available User Box functions	2-3
	Saving documents	2-3
	Using documents.....	2-4
	Organizing documents.....	2-6
2.1.2	Configuring settings for using the User Box functions	2-7
	Registering a User Box	2-7
	When using this machine as a relay device	2-7
	The User Box to which data is saved for memory reception.....	2-7
2.2	Information	2-8
2.2.1	User authentication.....	2-8
	MFP authentication.....	2-8
	External server authentication	2-8
	Account track authentication	2-9
2.2.2	Restriction of box registration.....	2-9
	Public/Personal/Group User Boxes	2-9
	Bulletin Board User Box.....	2-9
	Polling TX User Box	2-9
	Memory RX User Box	2-9
	Relay User Box	2-10
2.2.3	Restriction of file name	2-10
2.3	Authentication and accessible User Boxes.....	2-11
2.3.1	When User Authentication or Account Track is not enabled.....	2-11
2.3.2	When only user authentication is enabled	2-11
2.3.3	When only account track is enabled.....	2-12
2.3.4	When user authentication and account track are enabled and synchronized.....	2-12
2.3.5	When user authentication and account track are enabled but not synchronized	2-14

3 Control Panel/Liquid Crystal Display

3.1	Control panel	3-2
3.2	Touch panel	3-4
3.2.1	Screen component.....	3-4
	Icons that appear in the touch panel	3-4

3.2.2	Display and operation of Left panel	3-5
	Job List	3-6
	Job List - Delete.....	3-6
	Job List - Job Details	3-7
	User Box information	3-12
	Use/File - Detail.....	3-12
	Use/File - Check Job Settings	3-12
	Use/File - Check Job Settings - Destination Settings	3-13
	Use/File - Check Job Settings - Document Setting Contents	3-13
	Use/File - Check Job Settings - Communication Settings	3-14
	Use/File - Check Job Settings - Check E-Mail Settings	3-14
	Preview	3-14
	Preview	3-15
	Preview (Print/Combine)	3-15
	Preview (Send/Bind TX)	3-16

4 User Box Operation Flow

4.1	Saving documents in User Boxes.....	4-3
4.2	Printing documents from a User Box.....	4-5
4.3	Sending documents from a User Box	4-8
4.4	Saving a document in an external memory	4-11
4.5	Saving a Document from the External Memory into a User Box.....	4-13
4.6	Printing a document from an external memory	4-15
4.7	Filing documents in a User Box.....	4-17
4.8	Printing a Document Saved in a Cellular Phone or PDA	4-19
4.9	Saving a Document Stored in a Cellular Phone or PDA to a User Box	4-21
4.10	Menu tree of the User Box mode	4-23
4.10.1	Save Document.....	4-23
	Public, Personal, or Group User Box.....	4-23
	System User Box	4-24
4.10.2	Use/File	4-26
	Print (for Public/Personal/Group User Boxes)	4-26
	Send (for Public/Personal/Group User Boxes)	4-30
	Filing Settings (for public/personal/group User Boxes)	4-34
	Application (for Public/Personal/Group User Boxes).....	4-35
	System User Box	4-36

5 Accessing the User Box mode

5.1	Accessing the User Box mode	5-3
5.2	User Box Operation Menu.....	5-4
5.2.1	Save Document.....	5-4
5.2.2	Use/File	5-4

6 Save Document

6.1	Save Document Overview	6-3
6.1.1	Functions	6-3
	Public/Personal/Group User Boxes	6-3
	Annotation User Box.....	6-3
	External Memory	6-3
6.1.2	Initial Window of Save Document	6-4
	Public/Personal/Group User Boxes	6-4
	System User Box	6-4
6.1.3	Save Document window	6-5
6.2	Scan Settings	6-6
6.2.1	Basic - Original Type.....	6-6
6.2.2	Basic - Simplex/Duplex	6-7
6.2.3	Basic - Resolution.....	6-7



6.2.4	Basic - File Type	6-8
	File Type.....	6-8
	Encryption	6-9
	Encryption - Detail Settings	6-9
	Outline PDF.....	6-11
	Scan Setting.....	6-11
6.2.5	Basic - Density.....	6-12
6.2.6	Basic - Color	6-12
6.2.7	Scan Size	6-13
	Standard size	6-13
	Custom Size.....	6-13
	Photo Size.....	6-13
6.2.8	Image Adjustment.....	6-14
	Background Removal	6-14
	Sharpness	6-15
6.2.9	Application - Frame Erase	6-15
6.2.10	Application - Book Copy.....	6-16
	Book copy method	6-16
	Book Erase - Frame Erase	6-16
	Book Erase - Center Erase	6-17
	Binding Position	6-17
6.2.11	Separate Scan	6-18
6.3	Original Settings.....	6-19
6.3.1	Special Original	6-19
6.3.2	Direction Settings - Original Direction	6-19
6.3.3	Direction Settings - Binding Position	6-20
6.3.4	Despeckle	6-20

7 Use/File

7.1	Overview of the Use/File operations	7-3
7.1.1	Functions of Use/File	7-3
	Printing a document.....	7-3
	Sending.....	7-3
	Filing.....	7-3
	Application settings	7-3
7.1.2	Detail of the Use Document screen	7-4
7.1.3	If a password is specified for a User Box	7-5
7.2	Print	7-6
7.2.1	Overview of the Print tab	7-6
	Description of the Print tab.....	7-6
	Print.....	7-6
	Combine.....	7-7
7.2.2	Print.....	7-7
7.2.3	Combine.....	7-8
	Document Order	7-8
	Configurable items to combine and print documents	7-8
7.3	Print - Basic (Public, Personal, or Group User Box)	7-9
7.3.1	Copies.....	7-9
7.3.2	1-Sided/2-Sided.....	7-9
7.3.3	Color	7-10
7.3.4	Finishing.....	7-10
	Sort/Group	7-11
	Offset	7-11
	Staple.....	7-11
	Staple - Position Setting	7-11
	Punch	7-11
	Punch - Position Setting	7-12
	Fold/Bind.....	7-12
7.3.5	Combine.....	7-14

7.3.6	Zoom.....	7-15
7.3.7	Continuous Print.....	7-16
7.4	Print - Application (Public, Personal, or Group User Box)	7-17
7.4.1	Page Margin.....	7-17
	Page Margin.....	7-17
	Image Shift.....	7-17
	Image Shift - Change Back Shift	7-18
7.4.2	Sheet/Cover/Chapter Insert.....	7-18
7.4.3	Sheet/Cover/Chapter Insert - Cover Sheet.....	7-19
7.4.4	Sheet/Cover/Chapter Insert - Insert Sheet	7-20
7.4.5	Sheet/Cover/Chapter Insert - Chapters.....	7-21
7.4.6	Stamp/Composition.....	7-22
7.4.7	Stamp/Composition - Date/Time.....	7-22
7.4.8	Stamp/Composition - Page Number	7-23
	Settings.....	7-23
	Insert Sheet Setting	7-24
7.4.9	Stamp/Composition - Stamp.....	7-24
7.4.10	Stamp/Composition -Copy Security -Copy Protect	7-25
	Copy Protect Type.....	7-26
	Detail Settings.....	7-26
	Position	7-26
7.4.11	Stamp/Composition - Copy Security - Copy Guard.....	7-27
	Copy Guard Type.....	7-27
	Detail Settings.....	7-28
7.4.12	Stamp/Composition - Copy Security - Password Copy.....	7-28
	Stamp Type.....	7-29
	Detail Settings.....	7-29
7.4.13	Stamp/Composition - Stamp Repeat	7-30
	Stamp Repeat Type.....	7-30
	Detail Settings.....	7-31
	Position	7-31
7.4.14	Stamp/Composition - Header/Footer	7-31
	Check/Change Temporarily	7-32
7.4.15	Stamp/Composition - Registered Overlay	7-33
	Settings.....	7-33
	Overlay Setting.....	7-34
7.5	Send	7-35
7.5.1	Overview of the Transmission Settings.....	7-35
	Description of the Send tab	7-35
	Send.....	7-36
	Bind TX.....	7-36
7.5.2	Transmission Settings.....	7-37
7.5.3	Combine.....	7-38
	Document Order	7-38
7.6	Send (Public, Personal, or Group User Box).....	7-39
7.6.1	Address Book - Search.....	7-39
	Address Type.....	7-39
	Index	7-40
	Detail Search.....	7-40
	Detail Search - Search options	7-41
7.6.2	Direct Input	7-41
7.6.3	Direct Input - Fax	7-42
	Next Destination.....	7-42
	When the Confirm Address (TX) function is specified:	7-42
7.6.4	Direct Input - E-mail.....	7-42
	Next Destination.....	7-42

7.6.5	Direct Input - Internet Fax.....	7-43
	Next Destination.....	7-43
	Receiver RX Ability.....	7-43
7.6.6	Direct Input - IP Address Fax.....	7-44
7.6.7	Direct Input - PC (SMB).....	7-44
	Host Name.....	7-44
	File Path.....	7-44
	User Name.....	7-44
	Password.....	7-44
	Reference.....	7-45
	Next Destination.....	7-45
7.6.8	Direct Input - FTP.....	7-45
	Host Name.....	7-45
	File Path.....	7-45
	User Name.....	7-45
	Password.....	7-45
	Detail Settings.....	7-45
	Next Destination.....	7-45
7.6.9	Direct Input - WebDAV.....	7-46
	Host Name.....	7-46
	File Path.....	7-46
	User Name.....	7-46
	Password.....	7-46
	Detail Settings.....	7-46
	Next Destination.....	7-46
7.6.10	Job History.....	7-47
7.6.11	Address Search.....	7-47
7.6.12	LDAP Search - Search.....	7-48
7.6.13	LDAP Search - Advanced Search.....	7-48
	Name.....	7-48
	E-mail Addr.....	7-48
	Fax Number.....	7-48
	Last Name.....	7-48
	First Name.....	7-48
	City.....	7-48
	Company Name.....	7-49
	Department.....	7-49
	OR/AND/STARTS WITH/ENDS WITH.....	7-49
7.6.14	Overview of the Document Settings.....	7-49
7.6.15	Document Settings - Resolution.....	7-49
7.6.16	Document Settings - File Type.....	7-50
	File Type.....	7-50
	Encryption.....	7-51
	Encryption - Detail Settings.....	7-51
	Stamp Composition.....	7-53
	Outline PDF.....	7-53
	Scan Setting.....	7-54
7.6.17	Document Settings - Color.....	7-54
7.6.18	Overview of the Communication Settings.....	7-55
7.6.19	Communication Settings - Line Setting.....	7-55
	Description of Line Settings.....	7-55
	Overseas TX.....	7-55
	ECM OFF.....	7-56
	V.34 OFF.....	7-56
	Check Dest. & Send.....	7-56
	Select Line.....	7-56
7.6.20	Communication Settings - E-Mail Settings.....	7-57
	E-mail Settings.....	7-57
	Document Name.....	7-57
	Subject.....	7-57
	From.....	7-58
	Body.....	7-58

7.6.21	Communication Settings - URL Notification Setting	7-59
	URL Notification.....	7-59
	Detail Search.....	7-59
	Direct Input	7-59
7.6.22	Communication Settings - Communication Method Settings	7-60
	Timer transmission (Timer TX).....	7-60
	Password transmission (Password TX).....	7-61
	F-Code transmission (F-Code TX)	7-61
7.6.23	Communication Settings - E-mail Encryption.....	7-62
7.6.24	Communication Settings - Digital Signature.....	7-62
7.6.25	Communication Settings - Fax Header Settings	7-62
7.6.26	Overview of the Application settings	7-63
7.6.27	Application - Stamp/Composition - Date/Time	7-63
7.6.28	Application - Stamp/Composition - Page Number	7-63
7.6.29	Application - Stamp/Composition - Stamp	7-63
7.6.30	Application - Stamp/Composition - Header/Footer.....	7-63
7.6.31	Application - Send & Print.....	7-64
7.7	Filing Settings (Public, Personal, or Group User Boxes)	7-65
7.7.1	Overview of the Filing Settings	7-65
	Description of the Filing Settings tab.....	7-65
7.7.2	Deleting documents	7-66
7.7.3	Edit Name	7-66
7.7.4	Moving documents	7-66
7.7.5	Copy.....	7-67
7.7.6	Save in external memory	7-67
	Document Settings	7-68
	Document Settings - Resolution.....	7-68
	Document Settings -File Type	7-69
	Document Settings - Color	7-69
7.7.7	Document Details.....	7-70
	Displaying detailed information.....	7-70
	Preview	7-70
7.8	Application.....	7-71
7.8.1	Overview of the Application settings	7-71
	Description of the Application tab	7-71
7.8.2	Edit Document	7-72
	Edit Document - Delete Page	7-72
	Edit Document - Rotate Page.....	7-73
	Edit Document - Move Page.....	7-75
	Preview/Set Range	7-77
	Preview/Specify by Input	7-77
7.8.3	Register Overlay.....	7-79
	Register Overlay - New	7-80
	Register Overlay - Overwrite.....	7-81
	Detail Settings.....	7-82
7.9	Bulletin Board User Box (System User Box).....	7-83
7.9.1	Overview of the Bulletin Board User Boxes.....	7-83
7.9.2	Bulletin Board User Box screen.....	7-83
7.9.3	Printing a document in a Bulletin Board User Box	7-83
7.9.4	Deleting a document in the Bulletin Board User Box	7-83
7.10	Polling TX User Box (System User Box).....	7-84
7.10.1	Overview of the Polling Transmission User Boxes	7-84
7.10.2	Printing a document in the Polling TX User Box.....	7-84
7.10.3	Deleting a document in the Polling TX User Box.....	7-84
7.11	Secure Document User Box (System User Box)	7-85
7.11.1	Overview of the Secure Document User Box	7-85
7.11.2	Authentication procedure 1	7-85
7.11.3	Authentication procedure 2	7-85

7.11.4	Print - Printing	7-86
	Copies	7-86
	Print.....	7-86
	Color	7-86
	Finishing.....	7-86
	Combine.....	7-86
	Zoom.....	7-86
	Page Margin.....	7-86
	Sheet/Cover/Chapter Insert	7-86
	Stamp/Composition.....	7-86
7.11.5	Filing Settings	7-87
7.12	Memory RX User Box (System User Box).....	7-88
7.12.1	Overview of the Memory RX User Box	7-88
7.12.2	Print.....	7-88
7.12.3	Filing Settings	7-88
7.13	Annotation User Box (System User Box)	7-89
7.13.1	Overview of the Annotation User Box.....	7-89
7.13.2	Print - Basic	7-89
7.13.3	Print - Page Margin.....	7-89
7.13.4	Print - Sheet/Cover/Chapter Insert - Cover Sheet.....	7-90
7.13.5	Print - Sheet/Cover/Chapter Insert - Insert Sheet	7-90
7.13.6	Print - Sheet/Cover/Chapter Insert - Chapters	7-90
7.13.7	Print - Stamp/Composition - Date/Time	7-90
7.13.8	Print - Stamp/Composition - Page Number	7-90
7.13.9	Print - Stamp/Composition - Stamp.....	7-90
7.13.10	Print - Stamp/Composition - Copy Security - Copy Protect	7-90
7.13.11	Print - Stamp/Composition - Copy Security - Copy Guard	7-90
7.13.12	Print - Stamp/Composition - Copy Security - Password Copy	7-90
7.13.13	Print - Stamp/Composition - Stamp Repeat	7-90
7.13.14	Print - Stamp/Composition - Registered Overlay	7-90
7.13.15	Description of the Send tab	7-90
7.13.16	Send - Address Book - Search.....	7-90
7.13.17	Send - Direct Input - E-mail	7-90
7.13.18	Send - Direct Input - PC (SMB).....	7-91
7.13.19	Send - Direct Input - FTP.....	7-91
7.13.20	Send - Direct Input - WebDAV.....	7-91
7.13.21	Send - Job History	7-91
7.13.22	Send - LDAP Search - Search	7-91
7.13.23	Send - LDAP Search - Advanced Search	7-91
7.13.24	Send - Document Settings - Resolution	7-91
7.13.25	Send - Document Settings - File Type.....	7-91
7.13.26	Send - Document Settings - Color	7-91
7.13.27	Send - Communication Settings - E-mail Settings.....	7-91
7.13.28	Send - Communication Settings - URL Notification Setting.....	7-91
7.13.29	Send - Communication Settings - E-mail Encryption	7-91
7.13.30	Send - Communication Settings - Digital Signature.....	7-91
7.13.31	Send - Application - Stamp/Composition - Date/Time.....	7-91
7.13.32	Send - Application - Stamp/Composition - Page Number	7-92
7.13.33	Send - Application - Stamp/Composition - Stamp.....	7-92
7.13.34	Send - Application - Send & Print.....	7-92
7.13.35	Send - Application - Stamp Element	7-92
	Secondary Field	7-92
	Date/Time.....	7-92
	Density	7-92
	Number Type	7-93
	Print Position.....	7-93
7.13.36	Filing Settings	7-94
7.13.37	Application - Register Overlay	7-94

7.14	Fax Retransmit User Box (System User Box)	7-95
7.14.1	Overview of the Fax Retransmit User Box.....	7-95
7.14.2	Print - Proof Print.....	7-95
7.14.3	Send - Fax.....	7-95
7.14.4	Filing Settings - Delete.....	7-96
7.15	Password Encrypted PDF User Box (System User Box)	7-97
7.15.1	Overview of the Password Encrypted PDF User Box.....	7-97
7.15.2	Print/Save –Print/Save.....	7-97
7.15.3	Filing Settings - Delete.....	7-97
7.16	ID & Print User Box (System User Box)	7-98
7.16.1	Overview of the ID & Print User Box.....	7-98
	Viewing documents.....	7-98
7.16.2	Print - Print.....	7-99
7.16.3	Filing Settings - Delete.....	7-99
7.17	External Memory (System User Box)	7-100
7.17.1	External memory device.....	7-100
	Supported external memory devices.....	7-100
	Connecting the external memory device.....	7-100
7.17.2	External memory screen.....	7-101
	Entering a file path.....	7-101
	Selecting a file.....	7-101
	Printing encrypted PDF data.....	7-101
	Moving to the parent folder.....	7-101
	Opening a folder.....	7-101
	Print.....	7-101
	Document Details.....	7-102
7.17.3	Print - Basic.....	7-102
	Copies.....	7-102
	Color.....	7-102
	Print.....	7-102
	Binding Position.....	7-102
	Finishing.....	7-102
	Paper.....	7-103
7.17.4	Print- Application.....	7-103
	Stamp/Composition - Date/Time.....	7-103
	Stamp/Composition - Page Number.....	7-103
	Stamp/Composition - Stamp.....	7-103
	Stamp/Composition - Copy Security - Copy Protect.....	7-103
	Stamp/Composition - Copy Security - Copy Guard.....	7-103
	Stamp/Composition - Copy Security - Password Copy.....	7-103
	Stamp/Composition - Stamp Repeat.....	7-103
7.17.5	Filing Settings–Save in User Box.....	7-104
7.18	Mobile/PDA (System User Box)	7-105
7.18.1	Operating environment.....	7-105
7.18.2	Mobile/PDA - Print List.....	7-106
	Entering the PIN code.....	7-106
	Check printing preferences.....	7-106
7.18.3	Mobile/PDA - Save in User Box.....	7-107
	Entering the PIN code.....	7-107

8 User Box Settings

8.1	Menu tree of User Box Settings	8-3
8.1.1	User mode.....	8-3
8.1.2	Administrator Settings.....	8-4
8.2	User mode settings	8-6

8.2.1	Creating a User Box.....	8-6
	Public, Personal, or Group User Box.....	8-6
	Delete Empty User Box(es) (Administrator Settings)	8-7
	Bulletin Board User Box.....	8-7
	Relay User Box	8-9
8.2.2	Custom Display Settings - User Box Setting.....	8-10
	Default Tab.....	8-10
	Shortcut key.....	8-10
8.2.3	Cellular Phone/PDA Setting - Link File Error Notification	8-11
8.2.4	Cellular Phone/PDA Setting - Proxy Server Use.....	8-11
8.2.5	Cellular Phone/PDA Setting - Print Settings.....	8-12
	Basic - Print	8-12
	Basic - Color	8-12
	Basic - Paper	8-12
	Basic - Finishing.....	8-13
	Application - Margin.....	8-13
	Application - Stamp/Composition - Date/Time	8-13
	Application - Stamp/Composition - Page Number.....	8-13
	Application - Stamp/Composition - Stamp	8-13
	Application - Stamp/Composition - Copy Security - Copy Protect.....	8-13
	Application - Stamp/Composition - Copy Security - Copy Guard	8-13
	Application - Stamp/Composition - Copy Security - Password Copy	8-13
	Application - Stamp/Composition - Stamp Repeat.....	8-14
8.3	Administrator Settings.....	8-15
8.3.1	User Box permissions.....	8-15
	User types.....	8-15
	Public User Box and Personal or Group User Box.....	8-15
8.3.2	Creating a User Box.....	8-16
8.3.3	Creating Public, Personal, or Group User Box	8-16
8.3.4	Creating Bulletin Board User Box.....	8-16
8.3.5	Creating Relay User Box.....	8-16
8.3.6	Creating Annotation User Box	8-17
8.3.7	Maximum Number of User Boxes.....	8-19
	Public, Personal, or Group User Box.....	8-19
	Max. No. Of Use Boxes	8-19
	Maximum Number of User Boxes.....	8-19
8.3.8	User Box Setting.....	8-20
	Delete Unused User Box.....	8-20
	Delete Secure Print Documents.....	8-20
	Auto Delete Secure Document	8-21
	Encrypted PDF Delete Time.....	8-21
	ID & Print Delete Time.....	8-22
	Document Hold Setting.....	8-22
	External Memory Function Settings.....	8-23
	Allow/Restrict User Box	8-23
	ID & Print Delete after Print Setting.....	8-24
	Document Delete Time Setting	8-24
	ID & Print Settings.....	8-25
8.3.9	Cellular Phone/PDA Setting	8-25
8.3.10	User Box Administrator Setting	8-26
	Setting User Box administrator.....	8-26
	Logging in to this machine as the User Box administrator.....	8-26
	Administrator's available functions.....	8-26
8.3.11	Security Details	8-27
	Security Print Only	8-27
8.3.12	HDD Settings	8-27
	Check HDD Capacity	8-27
	Overwrite Temporary Data.....	8-28
	Overwrite All Data	8-29
	HDD Lock Password.....	8-30
	Format HDD	8-31
	HDD Encryption Setting.....	8-31

8.3.13	Stamp Settings	8-32
	Apply Stamps.....	8-32

9 PageScope Web Connection

9.1	Using PageScope Web Connection	9-3
9.1.1	Operating environment	9-3
9.1.2	Accessing PageScope Web Connection	9-3
9.1.3	Web browser cache	9-4
	For Internet Explorer	9-4
	For Netscape Navigator	9-4
	For Mozilla Firefox.....	9-4
9.1.4	Online help function	9-4
9.2	Login and logout	9-5
9.2.1	Login and logout flows.....	9-5
	When User Authentication or Account Track is not enabled	9-5
	When User Authentication or Account Track is enabled	9-7
9.2.2	Logout.....	9-8
9.2.3	Login	9-9
	Login options	9-9
	Logging in as a public user.....	9-10
	Logging in as a registered user.....	9-11
	Logging in to administrator mode.....	9-12
	Display mode in administrator mode	9-14
	Logging in as a User Box administrator.....	9-15
9.3	Page Configuration	9-16
9.4	User Mode Overview	9-18
9.4.1	Information	9-18
9.4.2	Job	9-19
9.4.3	User Boxes.....	9-19
9.4.4	Direct Print	9-20
9.4.5	Store Address	9-21
9.4.6	Customize	9-22
9.5	Handling a document in a User Box.....	9-23
9.5.1	Listing the documents saved in a User Box	9-23
	Open User Box	9-23
	File List.....	9-24
9.5.2	Printing a document.....	9-25
9.5.3	Sending a document to another machine.....	9-28
9.5.4	Downloading document data to your computer	9-31
9.5.5	Moving or copying a document to another User Box.....	9-34
9.5.6	Deleting a document.....	9-35
9.6	Administrator Mode Overview	9-37
9.6.1	Maintenance	9-37
9.6.2	System Settings.....	9-38
9.6.3	Security	9-39
9.6.4	User Authentication/Account Track.....	9-40
9.6.5	Network.....	9-41
9.6.6	User Boxes.....	9-42
9.6.7	Printer Settings	9-43
9.6.8	Store Address	9-44
9.6.9	Fax Settings	9-45
9.6.10	Wizard	9-46



10 Appendix

10.1	Error message list.....	10-3
10.2	Glossary	10-4

11 Index

11.1	Index by item	11-3
11.2	Index by button.....	11-6





Introduction

1 Introduction

1.1 Welcome

Thank you for purchasing this machine.

This User's Guide describes the functions, operating instructions, precautions for correct operation, and simple troubleshooting guidelines of this machine. In order to obtain maximum performance from this product and use it effectively, please read this User's Guide as necessary.

1.1.1 User's guides

Printed manual	Overview
[Quick Guide Copy/Print/Fax/Scan/Box Operations]	<p>This manual describes operating procedures and the functions that are most frequently used in order to enable you to begin using this machine immediately. This manual also contains notes and precautions that should be followed to ensure safe usage of this machine.</p> <p>Please be sure to read this manual before using this machine.</p> <p>This manual describes details on trademarks and copyrights.</p> <ul style="list-style-type: none"> • Trademarks and copyrights
User's guide DVD manuals	Overview
[User's Guide Copy Operations]	<p>This manual describes details on copy mode operations and the settings of this machine.</p> <ul style="list-style-type: none"> • Specifications of originals and copy paper • Copy function • Maintaining this machine • Troubleshooting
[User's Guide Enlarge Display Operations]	<p>This manual describes details on operating procedures of the enlarge display mode.</p> <ul style="list-style-type: none"> • Copy function • Scanning function • G3 fax function • Network fax function
[User's Guide Print Operations]	<p>This manual describes details on printer functions.</p> <ul style="list-style-type: none"> • Printer function • Setting the printer driver
[User's Guide Box Operations]	<p>This manual describes details on the boxed functions using the hard disk.</p> <ul style="list-style-type: none"> • Saving data in user boxes • Retrieving data from user boxes • Transferring and printing data from user boxes
[User's Guide Network Scan/Fax/Network Fax Operations]	<p>This manual describes details on transmitting scanned data.</p> <ul style="list-style-type: none"> • E-mail TX, FTP TX, SMB TX, Save in User Box, Web-DAV TX, Web Services • G3 fax • IP Address Fax, Internet Fax
[User's Guide Fax Driver Operations]	<p>This manual describes details on the fax driver function that transmits faxes directly from a computer.</p> <ul style="list-style-type: none"> • PC-FAX
[User's Guide Network Administrator]	<p>This manual describes details on setting methods for each function using the network connection.</p> <ul style="list-style-type: none"> • Network settings • Settings using PageScope Web Connection

User's guide DVD manuals**Overview**

[User's Guide Advanced Function Operations]

This manual describes details on functions that become available by registering the optional license kit and by connecting to an application.

- Web browser function
- Image panel
- PDF Processing Function
- Searchable PDF
- My panel and My address functions

1.1.2 User's Guide

This User's Guide is intended for users ranging from those using this machine for the first time to administrators.

It describes basic operations, functions that enable more convenient operations, simple troubleshooting operations, and various setting methods of this machine.

Note that basic technical knowledge about the product is required to enable users to perform maintenance work or troubleshooting operations. Limit your troubleshooting operations to the areas explained in this manual.

Should you experience any problems, please contact our service representative.

1.2 Conventions used in this manual

1.2.1 Symbols used in this manual

Symbols are used in this manual to express various types of information.

The following describes each symbol related to correct and safe usage of this machine.

To use this machine safely

⚠ WARNING

- This symbol indicates that a failure to heed the instructions may lead to death or serious injury.

⚠ CAUTION

- This symbol indicates that negligence of the instructions may lead to mishandling that may cause injury or property damage.

NOTICE

This symbol indicates a risk that may result in damage to this machine or documents. Follow the instructions to avoid property damage.

Procedural instruction

- ✓ This check mark indicates an option that is required in order to use conditions or functions that are prerequisite for a procedure.

1 This format number "1" represents the first step.

2 This format number represents the order of serial steps.

- This symbol indicates a supplementary explanation of a procedural instruction.

The operation procedures are described using illustrations.

- This symbol indicates transition of the control panel to access a desired menu item.

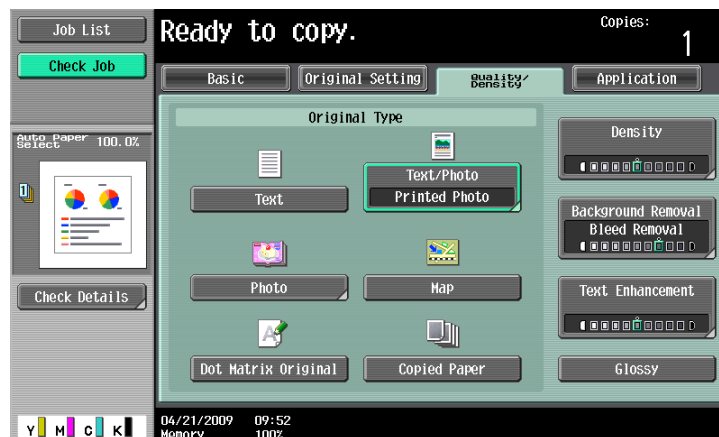

This symbol indicates a desired page.



Reference

This symbol indicates a reference.

View the reference as required.

Key symbols

[]

Key names on the touch panel or computer screen, or a name of a user's guide are indicated by these brackets.

Bold text

Key names, part names, product names and option names on the control panel are indicated in bold text.

1.2.2 Original and paper indications

Original and paper sizes

The following explains the indication for originals and paper described in this manual.

When indicating the original or paper size, the Y side represents the width and the X side the length.

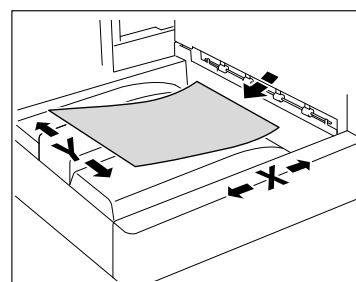

Original and paper indication

☐ indicates the paper size with the length (X) being longer than the width (Y).

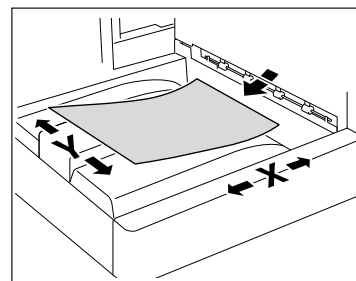

☐ indicates the paper size with the length (X) being shorter than the width (Y).

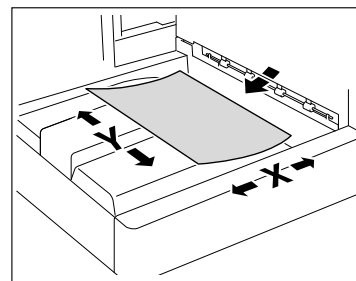

1.3 To check the function you want to use

This manual contains details on setting up the functions.

Understanding Operation Flow

This manual provides a chapter "User Box Operation Flow" that describes how to use the major functions of this machine. The flow charts in the chapter will help you understand the general flow of operations such as saving and printing data. Clicking the link in the flow chart takes you to the relevant function setting pages where you can see more detail.

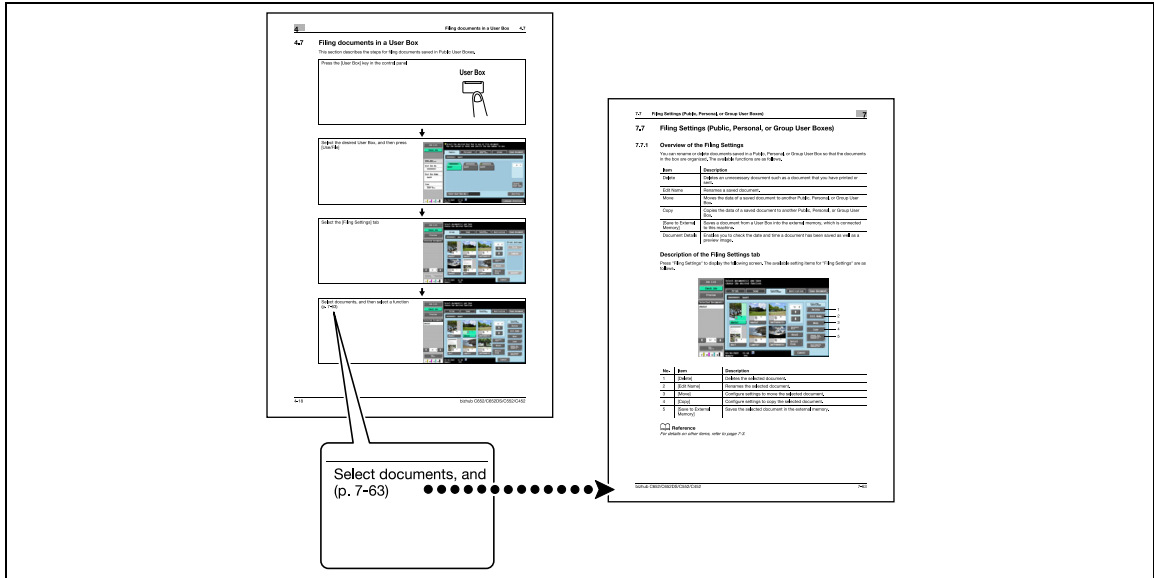

Using Menu Tree

Various functions can be configured for this machine. For information on what button to select to find specific setting items and the list of items that can be configured, refer to the Menu tree pages. In the menu tree pages, there is a hierarchy of functions under each button. Clicking the link in the menu tree takes you to the relevant function setting pages where you can see more details.

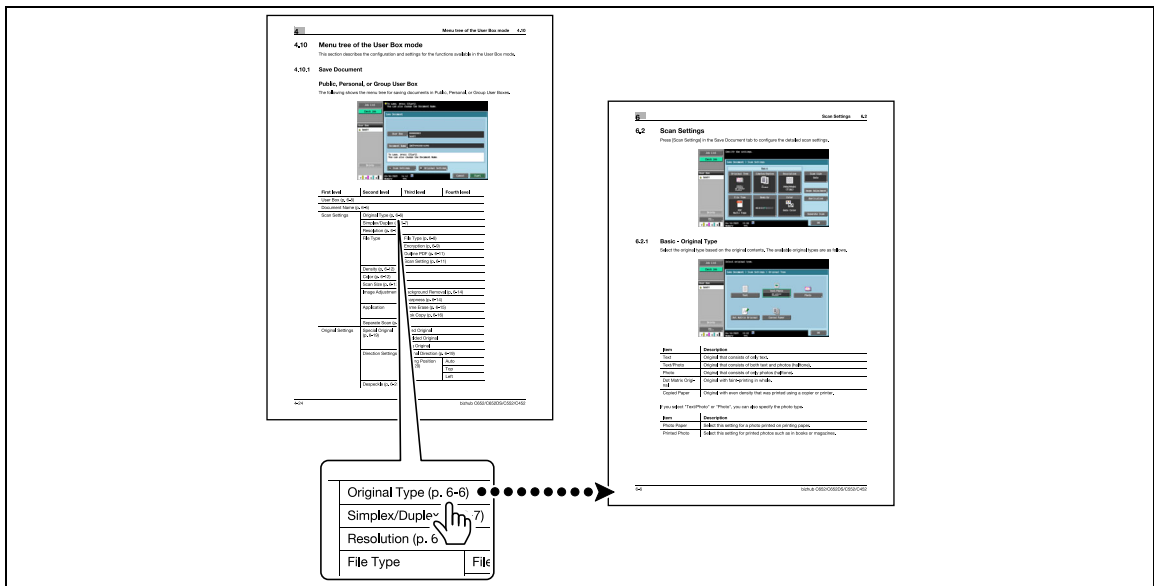

2 User Box Function Overview

2 User Box Function Overview

2.1 User Box functions

The User Box functions allow you to save document data to the machine's internal hard disk and later print them. Documents that can be saved are data scanned for copying and saved scan data. To save data to a box, create the box, and then save the data to the specified box. The saved data can be printed, sent by E-mail, transferred via FTP, or sent to a computer as may be necessary. Using the User Box functions enables you to save the effort involved in scanning originals repeatedly or saving data to each computer.

2.1.1 Available User Box functions

Saving documents

Data can be saved to the following boxes.

User Box	Description	Reference
Public/Personal/Group User Boxes (*1)	Save a document copied or scanned using this machine. You can also save a document that was print-instructed through a computer connected to a network. Some User Authentication or Account Track settings restrict users who can use User Boxes such as the Personal or Group User Box.	p. 6-3
Annotation User Box	Save document data to be printed and sent with an image of the date/time or an annotation number to documents saved in Scan mode.	p. 6-3
External Memory	This item appears when an external memory device is installed. <ul style="list-style-type: none"> You can save all scanned documents directly in an external memory connected to this machine. You can save a document stored in a User Box in an external memory. You can save a file stored in an external memory in a User Box. 	p. 6-3
Mobile/PDA	Save a document stored in a cellular phone or PDA in the Public, Personal, or Group User Box.	p. 7-107

*1 For details on how to send documents for print job from a computer and save them in the User Box, refer to the [User's Guide Print Operations].

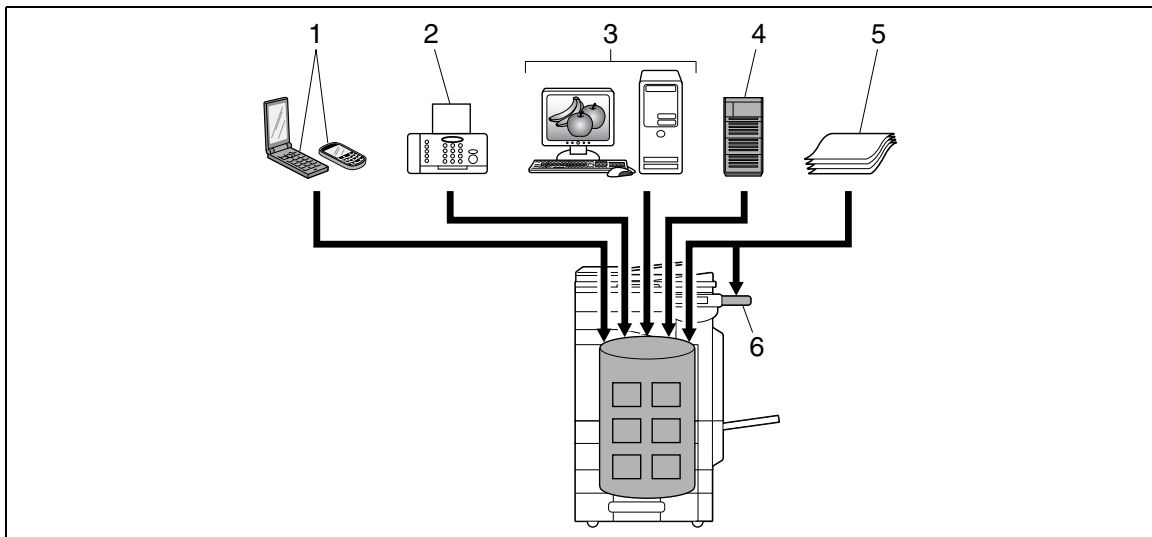

- 1 Mobile/PDA
- 2 Fax
- 3 Computer
- 4 FTP server, etc.
- 5 Original
- 6 External Memory

Using documents

Use the document data saved in boxes. Depending on the box, you can use the data as follows:

User Box	Description	Reference
Public/Personal/Group User Boxes (*1)	Print and send saved documents. You can also select multiple documents for printing/transmission. Some User Authentication or Account Track settings restrict users who can use User Boxes such as the Personal or Group User Box.	p. 7-9
Bulletin Board User Box	This item appears when the optional Fax Kit is installed. You can print a document saved in the Bulletin Board User Box.	p. 7-83
Polling TX User Box (*2)	This item appears when the optional Fax Kit is installed. You can print documents sent via polling.	p. 7-84
Secure Document User Box (*3)	Print saved documents. Enter an ID and password for printing.	p. 7-85
Memory RX User Box (*2)	This item appears when the optional Fax Kit is installed. You can confirm and print the fax document received through the memory RX setting.	p. 7-88
Annotation User Box	Print or transmit document data saved in Scan mode with an image of the date/time or an annotation number.	p. 7-89
Fax Retransmit User Box (*2)	This item appears when the optional Fax Kit is installed. With this User Box, you can resend a saved document or print it for confirmation.	p. 7-95
Password Encrypted PDF User Box (*4)	Print a saved password encrypted PDF document. Encrypted PDF files saved in an external memory and sent for print jobs are also saved in this box. The predefined password is required for printing.	p. 7-97
ID & Print User Box	This item appears when user authentication settings are configured. You can log in as a user and print a document sent for print jobs from the printer driver.	p. 7-98
External Memory	This item appears when an external memory device is installed. You can print documents saved in an external memory connected to this machine.	p. 7-100

User Box	Description	Reference
Mobile/PDA	Print a document saved in a cellular phone or PDA. You can save a document stored in a cellular phone or PDA in the Public, Personal, or Group User Box.	p. 7-106

*1 For details on how to send documents for print job from a computer and save them in the User Box, refer to the [User's Guide Print Operations].

*2 For details on polling transmission, polling reception, memory reception, and file retransmission, refer to the [User's Guide Network Scan/Fax/Network Fax Operations].

*3 For details on how to save documents to the Secure Document User Box, refer to the [User's Guide Print Operations].

*4 For print instruction of an encrypted PDF, refer to the **PageScope Direct Print** manual or the direct print in the **PageScope Web Connection** online help.

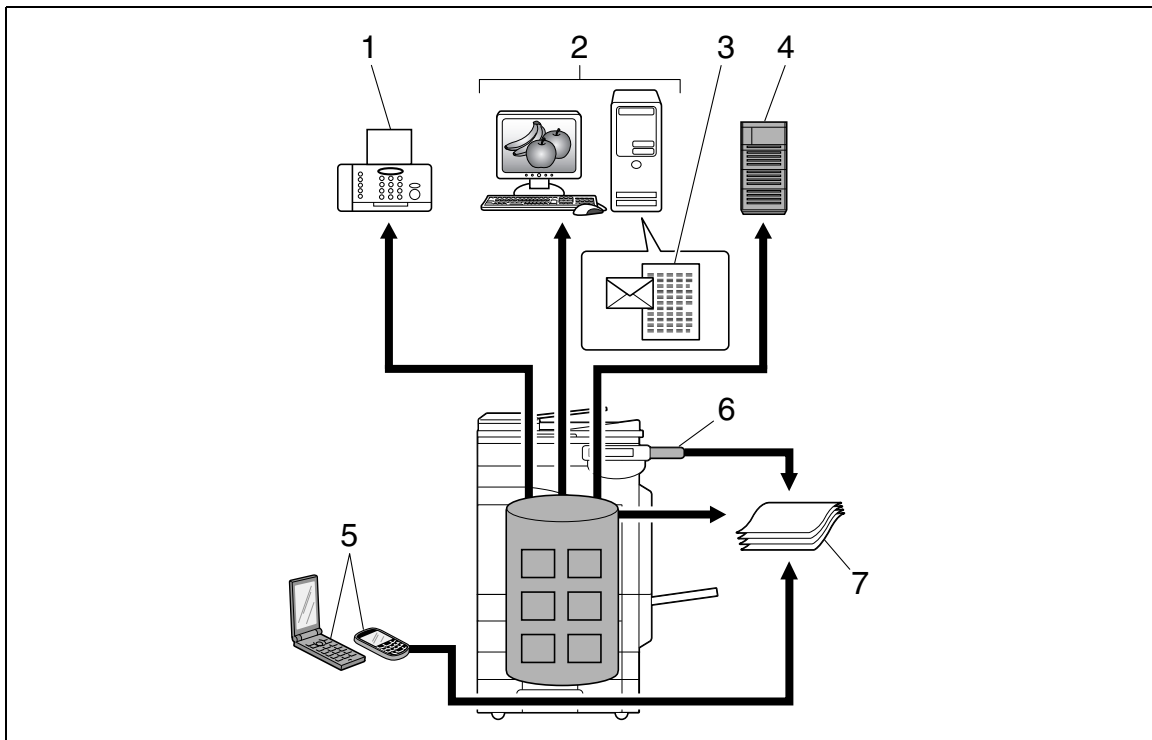

- 1 Fax
- 2 Computer
- 3 E-mail, etc.
- 4 FTP server, etc.
- 5 Cellular phone or PDA
- 6 External memory
- 7 Printout

Organizing documents

Organize documents by renaming the saved document, changing the boxes where they are saved, or duplicating or deleting them.

User Box	Delete	Edit Name	Move	Copy	Save in User Box	Save in USB memory (when external memory is connected)	Document Details
Public/Personal/Group User Boxes	○	○	○	○	–	○	○
Bulletin Board User Box	○	–	–	–	–	–	–
Polling TX User Box	○	–	–	–	–	–	–
Secure Document User Box	○	○	–	–	–	–	○
Memory RX User Box	○	○	–	–	–	–	○
Annotation User Box	○	○	–	–	–	–	○
Fax Retransmit User Box	○	–	–	–	–	–	○
Password Encrypted PDF User Box	○	–	–	–	–	–	○
ID & Print User Box	○	–	–	–	–	–	○
External Memory, Mobile/PDA	–	–	–	–	○	–	○

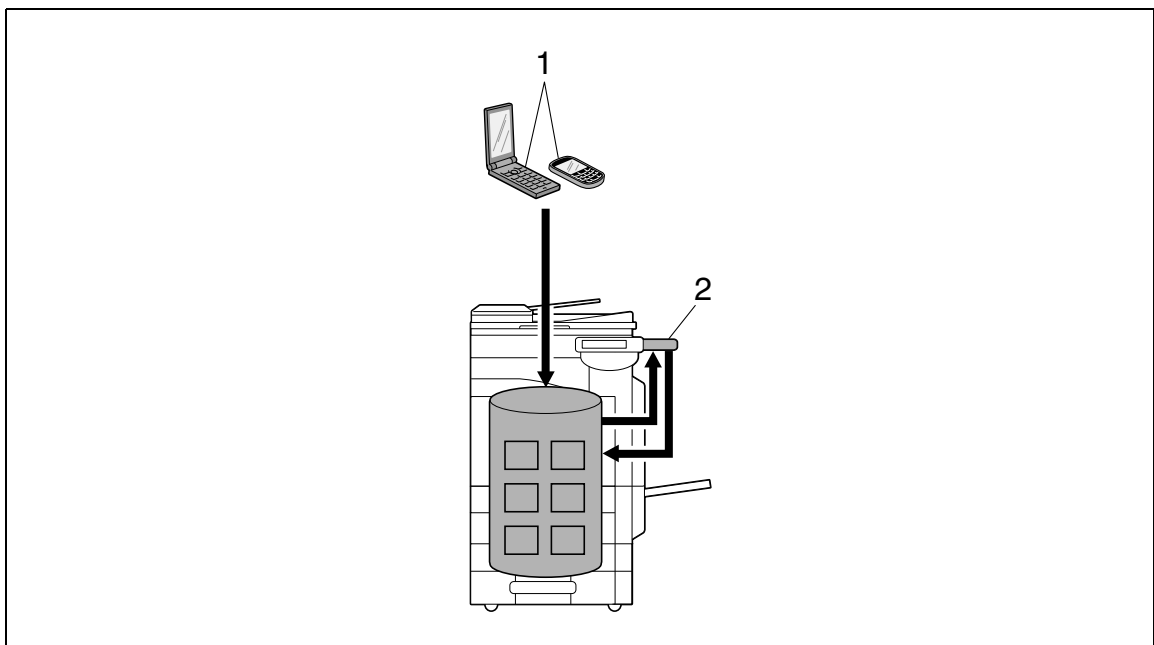

- 1 Mobile/PDA
- 2 External Memory

2.1.2 Configuring settings for using the User Box functions

Before using the User Box functions, the following settings should be configured.

Registering a User Box

Save the User Box where documents will be registered. Configure boxes by using the machine's touch panel or by using **PageScope Web Connection** from a Web browser on a computer on the network.

Reference

- The following User Boxes are configurable.
- Public/Personal/Group User Boxes(p. 8-6)
- Bulletin Board User Box (when using the bulletin board function) (p. 8-7)
- Annotation User Box (p. 8-17)

When using this machine as a relay device

If the optional **Fax Kit** is installed, and you want to use this machine for relaying fax transmission, create a Relay User Box for saving documents temporarily before they are relayed. (p. 8-9)

To create a Relay User Box, specify in advance the group containing fax numbers of relay destinations.

The User Box to which data is saved for memory reception

If the optional **Fax Kit** is installed, and you do not want to print while receiving data, configure the memory reception settings.



Reference

For details on how to configure memory reception settings, refer to the [User's Guide Network Scan/Fax/Network Fax Operations].

2.2 Information

This section describes information you should know before using the User Box functions.

2.2.1 User authentication

To use this machine, some devices have been preset so that you must enter an account or user name and a password. For details on the account or user name available for using the devices, contact your administrator.

MFP authentication

Enter the user name and password, and then press either [Login] in the touch panel or the **Access** key on the control panel.



External server authentication

Enter the user name and password, and then press either [Login] in the touch panel or the **Access** key on the control panel.



Account track authentication

Enter the account name and password, and then press either [Login] in the touch panel or the **Access** key on the control panel.



Reference

- When user authentication is enabled, the only the boxes accessible by the logged in users are displayed. For details, refer to page 2-11.
- When "Prohibited Functions When Authentication Error" in Administrator Settings is set to "Mode 2" and a user enters an incorrect password the specified number of times, that user is locked out and can no longer use the machine. For details on how to disable Prohibit Functions When Authentication Error, contact your administrator.
- If **PageScope Authentication Manager** is used for authentication, ask your server administrator about the login procedure.
- When you use the optional **Authentication Unit** for authentication, refer to the [User's Guide Copy Operations] for the login procedure.

2.2.2 Restriction of box registration

Public/Personal/Group User Boxes

The User Box functions provide Public User Boxes, which can be used by more than one person, Personal User Boxes, which can be used only by a single person, and Group User Boxes, which can be used by the users who are logged in as members of the User Box owner account.

The following lists the limitations on those User Boxes:

- Before saving documents, create a User Box to save data.
- Up to 1,000 User Boxes can be created.
- Up to 200 documents can be saved in a single User Box.
- A total of 10,000 pages can be saved in all User Boxes.
- A total of 3,000 documents can be saved in all User Boxes.

Bulletin Board User Box

Reference

- Up to 10 Bulletin Board User Boxes can be created.
- Only one document can be saved in a single Bulletin Board User Box.

Polling TX User Box

Only one document can be saved in a single User Box.

Memory RX User Box

Up to 500 documents can be saved in the Memory RX User Box.

Relay User Box

Reference

- Up to 5 Relay User Boxes can be created.
- Only one document can be saved in a single Relay User Box.

2.2.3 Restriction of file name

Name document data to be saved.

Reference

- The names can contain up to 30 characters.
- You can edit the names after the documents have been saved.
- Press this button to specify the name when saving data. Otherwise, a predefined name is applied to the data.

The following elements are combined to create a name. The following describes elements of an example document name "CKMBT_C65210102315230".

Item	Description
C	This character indicates the mode when the document is saved. "S" appears for documents saved in the Fax/Scan mode screen or the User Box screen. C: Copy S: Fax/Scan, Box P: Print
KMBT_C652	This represents the name of the device that scanned the data. The factory default is "KMBT_(product name)". You can change this name in [Device Name] in [Administrator/ Machine Settings] in Administrator Settings. Use up to 10 characters.
10102315230	This indicates the year (last two digits), month, day, hour and minute when the data was scanned. If a series of documents are scanned at the same time (minute), serial numbers are attached to the last digits.
_0001	This indicates the page when multi-page data is scanned. This numeral does not appear in the Document Name column, but is added automatically as part of the name when the file is transmitted. Consider this part for FTP or other transmission when a server has restriction regarding file names.
.TIF	This is the extension for the specified data format. The characters do not appear in the Document Name column, but is added automatically as part of the name when the file is transmitted.

2.3 Authentication and accessible User Boxes

When you apply user authentication and account track settings, the accessible User Boxes and the permissions change as shown in the following. Configure the user authentication and account track settings according to the desired functions.

2.3.1 When User Authentication or Account Track is not enabled

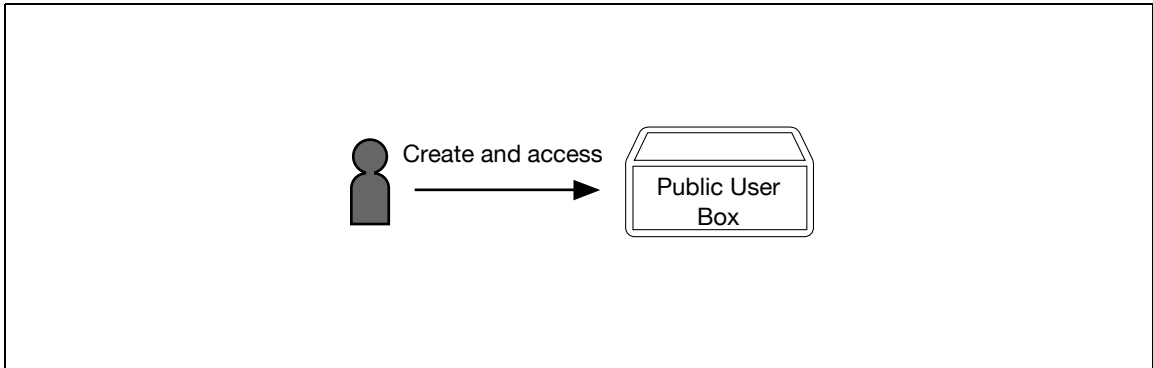

Reference

- Users can access all Public User Boxes.
- User Boxes created by users and administrators are Public User Boxes.
- Users cannot create any User Boxes when the Allow/Restrict User Box is set to Restrict in Administrator Settings.

2.3.2 When only user authentication is enabled

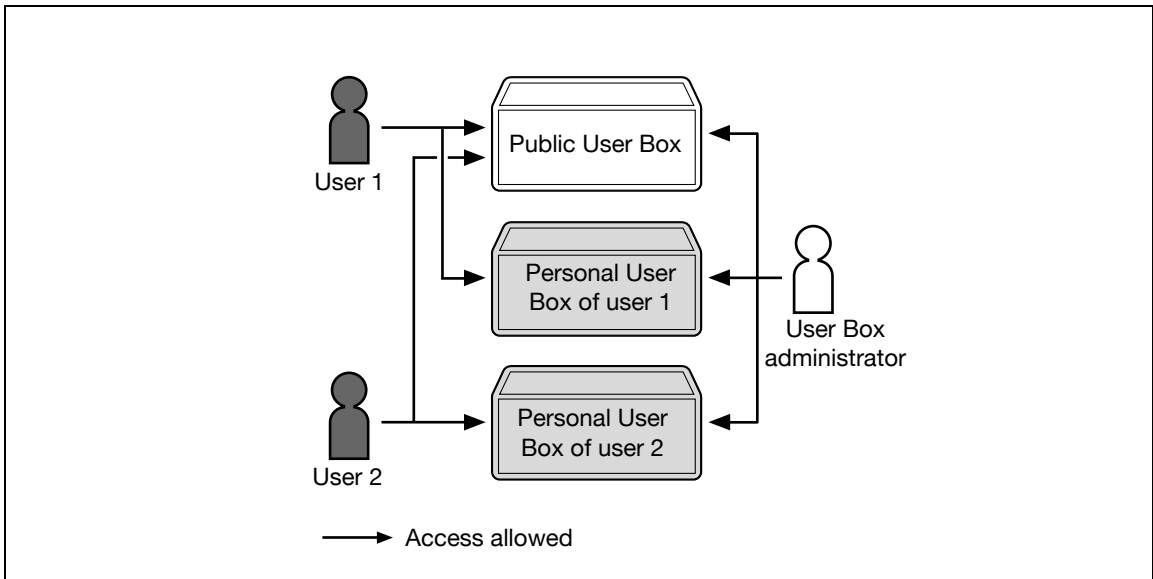

Reference

- Users can access all Public User Boxes and only Personal User Boxes that the user has created.
- The Personal User Boxes are inaccessible by other users.
- Press this button to set up a User Box administrator.
- A User Box administrator can access all Public User Boxes and all Personal User Boxes.
- If you delete authentication data by canceling user authentication settings or changing authentication methods, all Personal User Boxes become Public User Boxes.

2.3.3 When only account track is enabled

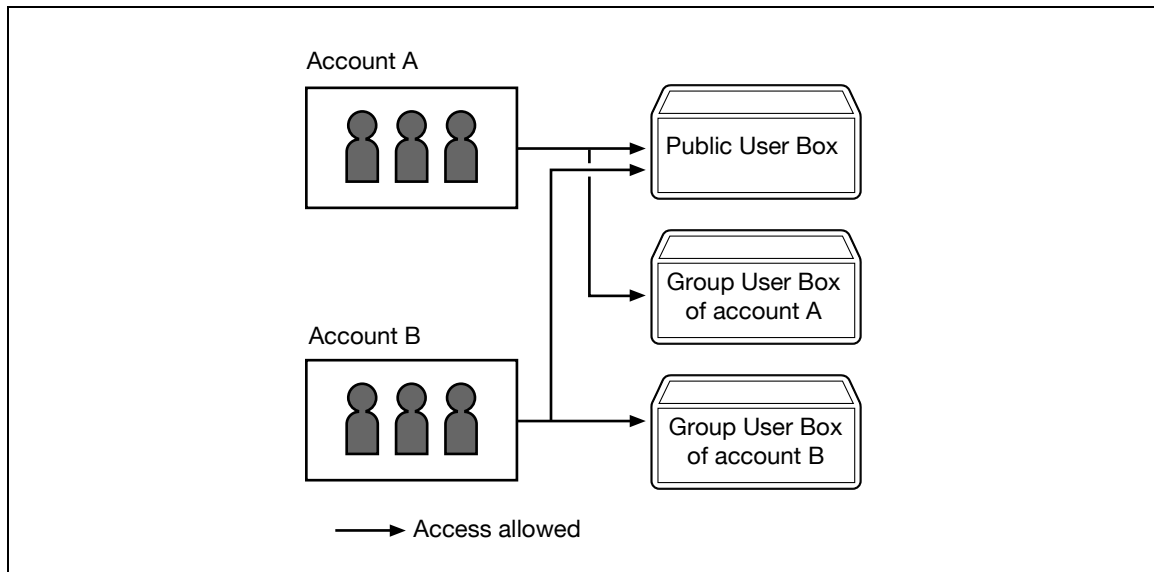

Reference

- Users can access all Public User Boxes and only Group User Boxes of accounts that the user belongs to.
- If you delete authentication data by canceling account track settings or changing authentication methods, all Group User Boxes become Public User Boxes.

2.3.4 When user authentication and account track are enabled and synchronized

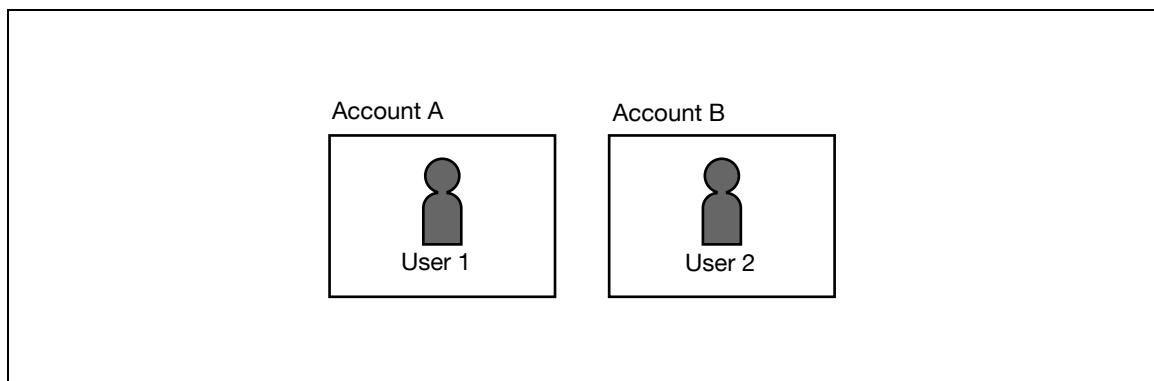

As the account for users has been registered in advance, users cannot access Group User Boxes of accounts that they do not belong to.

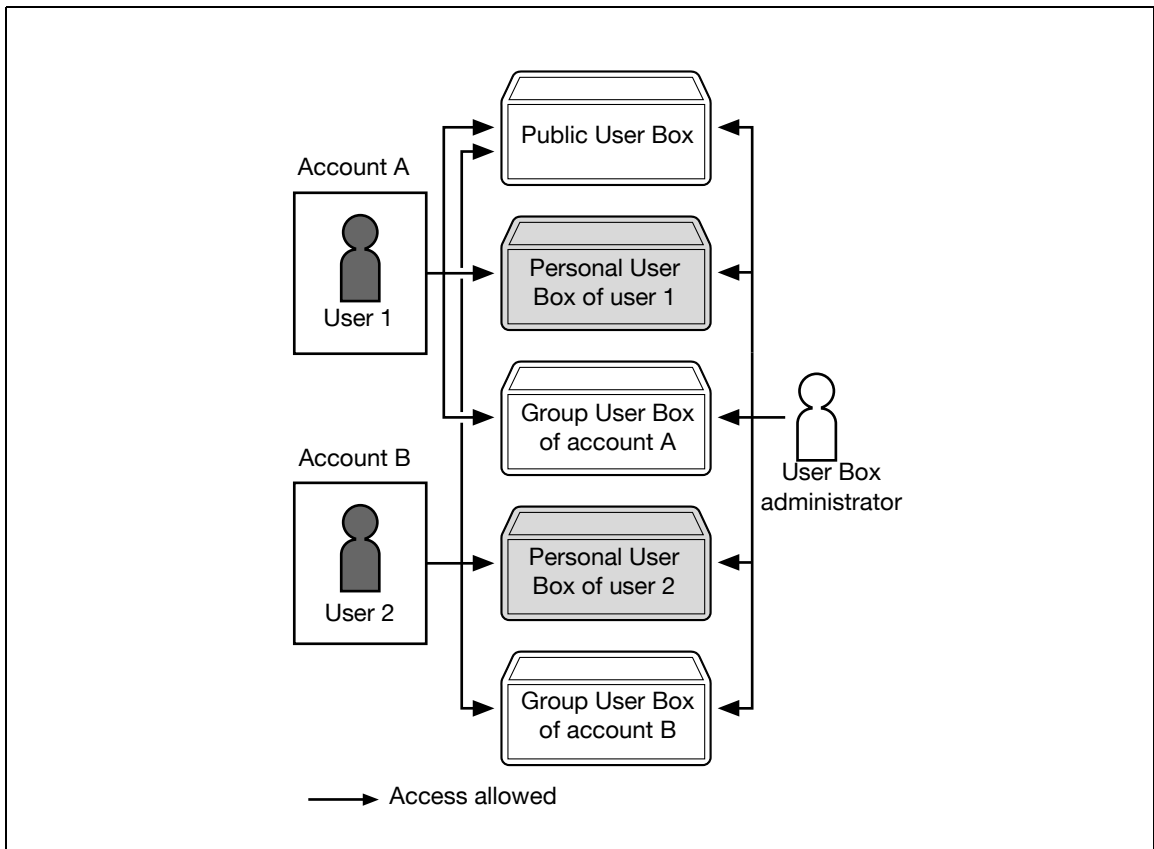

Reference

- Users can access all Public User Boxes, only Group User Boxes of the account that the user belongs to, and only Personal User Boxes that the user has created.
- The Personal User Boxes are inaccessible by other users.
- Press this button to set up a User Box administrator.
- A User Box administrator can access all Public User Boxes, all Personal User Boxes and all Group User Boxes.
- If you delete authentication data by canceling user authentication settings or changing authentication methods, all Personal User Boxes and all group boxes become Public User Boxes.

2.3.5 When user authentication and account track are enabled but not synchronized

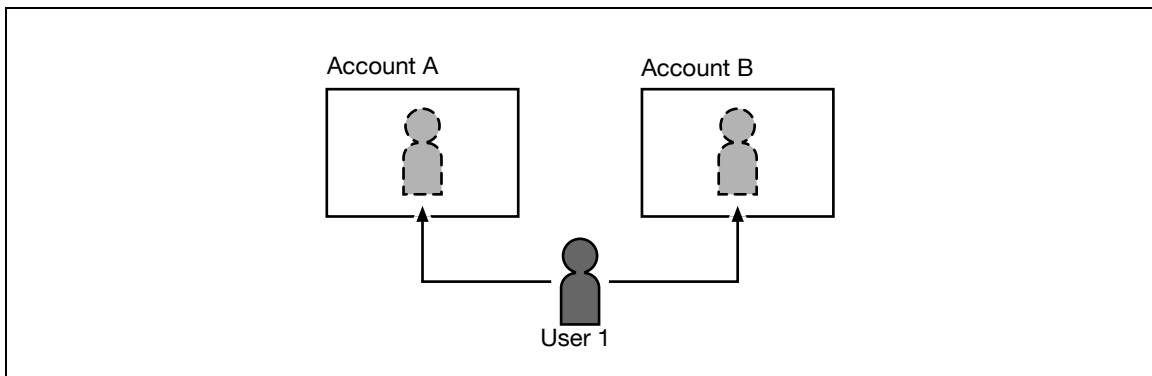

As the account for a user has not been registered in advance, a user must enter an account name and password when logging in. Each time a user logging in, the user can access the Group User Boxes of a different account by as a member of the account.

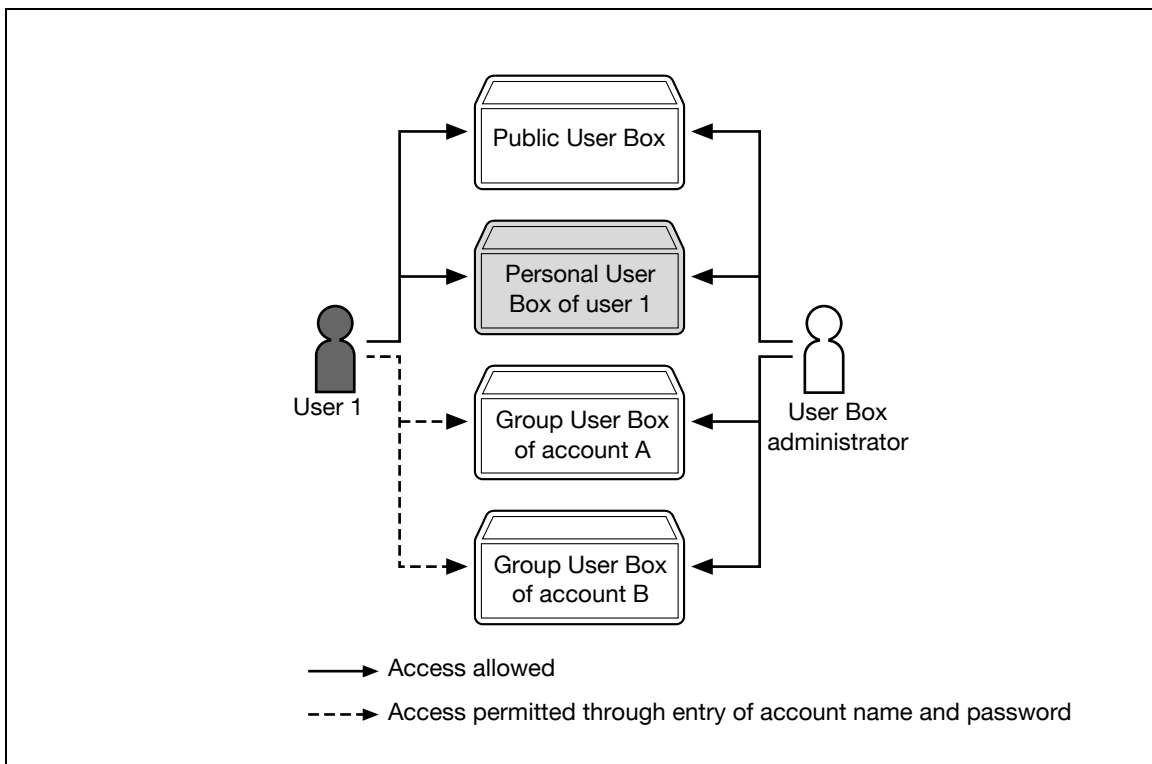

Reference

- Users can access all Public User Boxes and only Personal User Boxes that the user has created.
- The Personal User Boxes are inaccessible by other users.
- A user can access Group User Boxes of an account simply by entering an account name and password of the account when logging in.
- Press this button to set up a User Box administrator.
- A User Box administrator can access all Public User Boxes, all Personal User Boxes and all Group User Boxes.
- If you delete authentication data by canceling user authentication settings or changing authentication methods, all Personal User Boxes and all group boxes become Public User Boxes.



**Control Panel/Liquid Crystal
Display**

3 Control Panel/Liquid Crystal Display

3.1 Control panel

Use the control panel for User Box mode operation. The following describes the buttons and switches in the control panel.

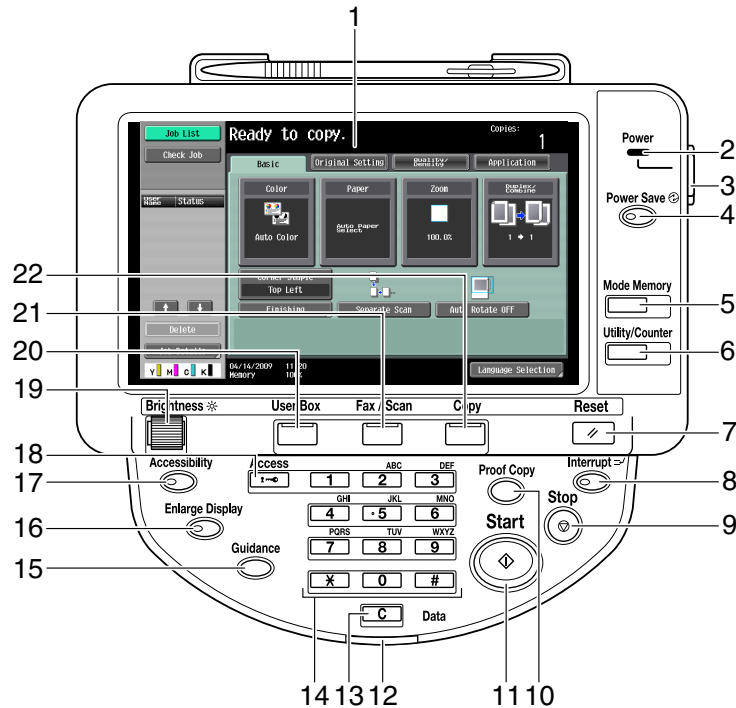

No.	Name	Description
1	Touch Panel	Various screens and messages are displayed. Configure the various settings by directly touching the panel.
2	Power Indicator	Lights up in blue when the machine is turned on with the main power switch.
3	Sub Power Switch	Press this switch to turn on/off machine operations, including copying, printing and scanning. When turned off, the machine enters an energy conservation state.
4	Power Save	Press this key to enter Power Save mode. While the machine is in Power Save mode, the indicator on the Power Save key lights up in green and the touch panel goes off. To exit from Power Save mode, press the Power Save key again.
5	Mode Memory	Press this key to register (store) the desired copy/scan settings as a program or to recall a registered copy/scan program.
6	Utility/Counter	Press this key to display the Utility screen and the Meter Count screen.
7	Reset	Press this key to clear all settings (except programmed settings) entered using the control panel and touch panel.
8	Interrupt	Press this key to enter Interrupt mode. While the machine is in Interrupt mode, the indicator on the Interrupt key lights up in green and the message "Now in Interrupt mode." appears on the touch panel. To cancel Interrupt mode, press the Interrupt key again.
9	Stop	Pressing the Stop key during scanning temporarily stops the scan operation.

No.	Name	Description
10	Proof Copy	Press this key to print a single proof copy to be checked before printing a large number of copies. You can check the finishing state on the touch panel by pressing this key before scanning or copying. <ul style="list-style-type: none"> This key is not available when saving documents by pressing the User Box key. To check the preview image when saving in a User Box, press the Fax/Scan key. For checking preview procedure, refer to the [User's Guide Network Scan/Fax/Network Fax Operations].
11	Start	Press this key to start scanning. When this machine is ready to begin a scan operation, the indicator on the Start key lights up in blue. If the indicator on the Start key lights up in orange, scan operation cannot be started. Press this key to restart a stopped job.
12	Data Indicator	Flashes in blue while a print job is being received. Lights up in blue when data is being printed.
13	C	Press this key to erase a value (such as the number of copies, a zoom ratio, or a size) entered using the keypad.
14	Keypad	Press this key to enter the number of copies, zoom ratio, and various other settings.
15	Guidance	Press this key to display the Guidance screen. From this screen, you can view descriptions of the various functions and details of operations.
16	Enlarge Display	Press this key to enter Enlarge Display mode. If you use PageScope Authentication Manager for authentication, the Enlarge Display screen is not available.
17	Accessibility	Press this key to display the screen for configuring settings for user accessibility functions.
18	Access	If user authentication or account track settings have been applied, press this key after entering the user name and password (for user authentication) or the account name and password (for account track) in order to use this machine. Press this key to log off from the machine as well.
19	Brightness adjustment dial	Use this dial to adjust the brightness of the touch panel.
20	User Box	Press this key to enter User Box mode. While the machine is in User Box mode, the indicator on the User Box key lights up in green.
21	Fax/Scan	Press this key to enter Fax/Scan mode. While the machine is in Fax/Scan mode, the indicator on the Fax/Scan key lights up in green. For details on the fax and scan functions, refer to the [User's Guide Network Scan/Fax/Network Fax Operations].
22	Copy	Press this key to enter Copy mode. (As a default, the machine is in Copy mode.) While the machine is in Copy mode, the indicator on the Copy key lights up in green. For details, refer to the [User's Guide Copy Operations].

CAUTION

- Do not apply extreme pressure to the touch panel, otherwise the touch panel may be scratched or damaged. Never push down on the touch panel with force, and never use a hard or pointed object to make a selection in the touch panel.

3.2 Touch panel



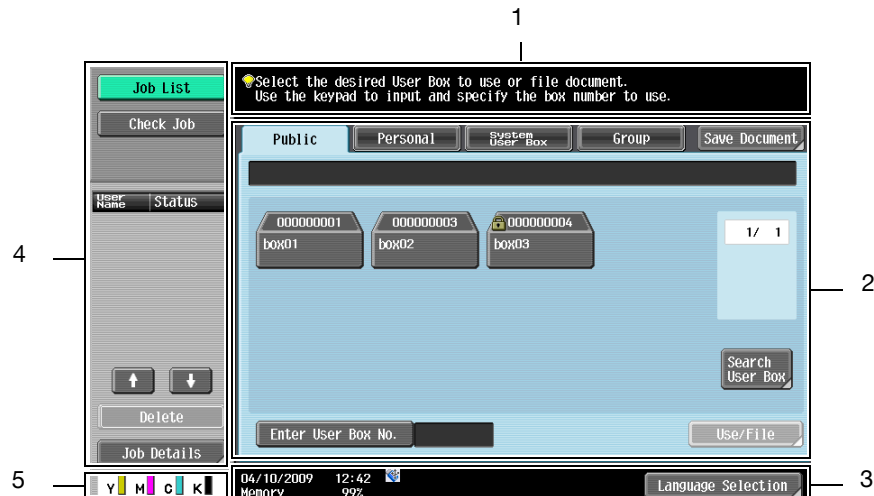

3.2.1 Screen component











No.	Name	Description
1	Message display area	Displays the status of the machine and details on operation procedures.
2	Functions/settings display area	Displays tabs and buttons for displaying screens containing various functions. Use this area to configure various functions. Press a tab or button to display the corresponding screen for configuring the settings.
3	Icon display area	Displays icons, which indicate the status of jobs and the machine, and shortcut keys.
4	Left panel	Displays various buttons, such as [Job List] to display the jobs that are currently being performed/queued (waiting) to be performed, and [Check Job] to display the result of the specified settings. For details on the display and description of the left panel, refer to page 3-5.
5	Toner supply indicators	Show the amount of toner remaining for yellow (Y), magenta (M), cyan (C), and black (K).

Icons that appear in the touch panel

Icons indicating the status of this machine may appear in the icon display area. The following icons may be displayed.

Icon	Description
	Indicates that data is being sent from the machine, regardless of the current mode.
	Indicates that the machine is receiving data, regardless of the current mode.
	Indicates that an error occurred during an image stabilization operation, a print operation or a scan operation. Press this icon to view a screen containing a warning code.
	If the warning screen has been closed while a warning occurs, press this button to display the warning screen again.

Icon	Description
	Appears when there is a message indicating that consumables must be replaced or the machine requires maintenance. Press this icon to display the message, and then perform the replacement or maintenance procedure.
	Appears when an error occurs with the connection to the POP server.
	Indicates that there is no paper in the paper tray.
	Indicates that very little paper remains in the paper tray.
	If the optional Image Controller is installed, pressing this icon displays the setting screen for the image controller.
	Indicates that the enhanced security mode is enabled.
	Indicates that an external memory device is connected to the machine.
	Indicates that a nonstandard external memory has been connected to this machine, therefore, USB connection is not enabled.
	Indicates that the job is in the waiting-for-redial status because, for example, the recipient's line is busy when sending with the G3 Fax or IP Address Fax function.

3.2.2 Display and operation of Left panel

In the left panel of the touch panel, there are buttons for checking the status of jobs and the configuration of the machine. The following buttons are available in the left panel in the User Box mode.

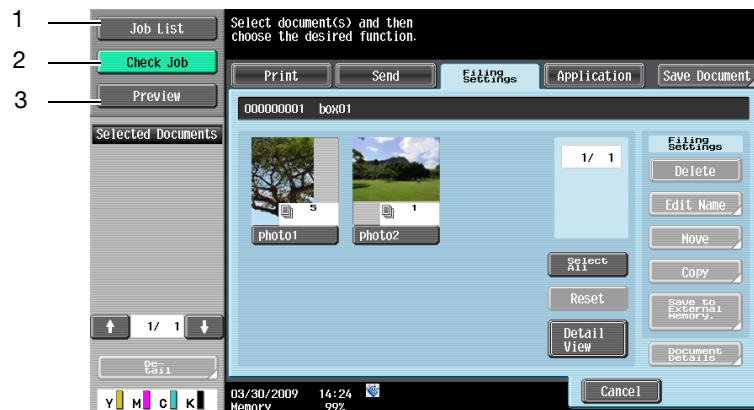

No.	Name	Description
1	[Job List]	Press this button to check the job currently being performed and the job log.
2	[Check Job]	Press this button to check information of the selected User Box, and various settings of the scan, print and transmission functions.
3	[Preview]	Press this button to check the preview image of a saved document.

Job List

A command to perform an operation such as saving data to a User Box, or printing or sending saved documents is called a job. Select [Job List] to display the job currently being performed.

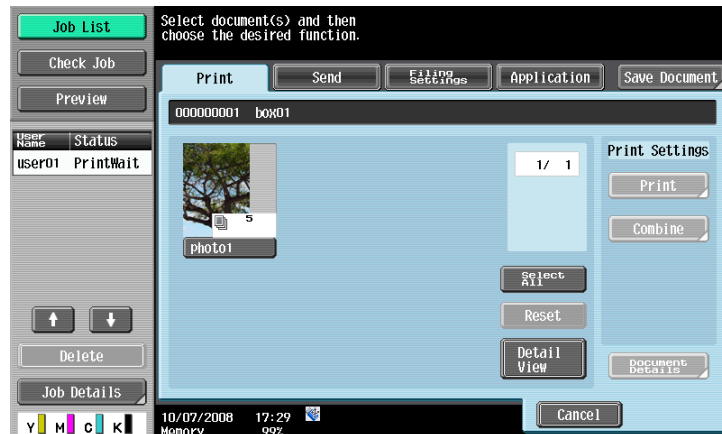

Job List - Delete

Press this button to delete the job in process to cancel the operation. Select the job from the job list, and then press [Delete]. Check the message that appears, and delete the job.

No documents in a User Box will be deleted even if the job currently being run is deleted.



Job List - Job Details

Press this button to view the list of jobs being performed and the job log for confirmation. There are the following four types of jobs:

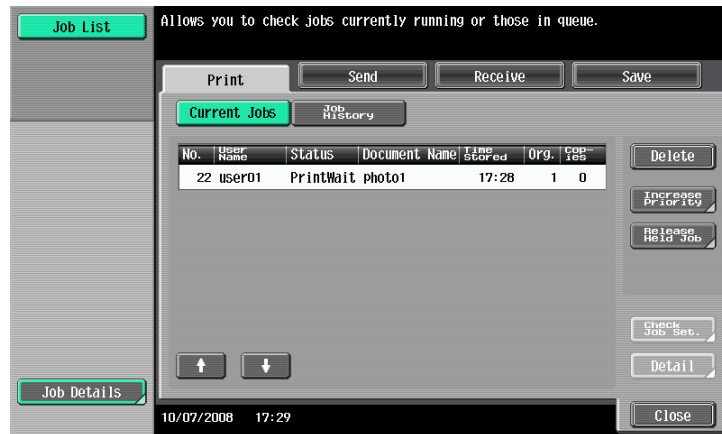

Item	Description
[Print]	Lists print jobs for copying, computer printing, and received faxes.
[Send]	Lists scanner and fax transmission jobs.
[Receive]	Lists fax reception jobs.
[Save]	Lists jobs with documents being saved in User Boxes.

<Current Jobs of [Print]>

Item	Description
List items	No.: Job identification number assigned when the job is queued. User Name: Displays the user name or user name/account name of the user who stored the document. Status: Displays the status of the job (receiving/queued/printing/printing stopped/print error). Document Name: File name being printed. Time Stored: Displays the time that the job was queued. Org.: Displays the number of pages in the original. Copies: Displays the number of copies to be printed.
[↑][↓]	When there are more than the upper limit of seven jobs to be displayed at one time, press these buttons to display other jobs.
[Delete]	Press this button to delete the selected job.
[Increase Priority]	Press this button to change the priority of the job. <ul style="list-style-type: none"> If you set Changing Job Priority in Administrator Settings to "Restrict", you cannot specify the output priority of the jobs. If the setting is specified so that the current print job can be interrupted, printing is interrupted and printing of the job given priority begins. Printing of the interrupted job restarts automatically once printing for the job given priority is finished.
[Release Held Job]	Press this button to change the settings of a stored job, or print or delete the job.
[Check Job Set.]	Press this button to check the settings of the selected job. Press either [← Back] or [Forward →] to check the settings.
[Detail]	Press this button to check the registration source/user name, file name, output tray, stored time, number of original pages and number of copies for the selected job. To delete a job, press [Delete].

Reference

- When user authentication settings are applied, the names of documents that have not been saved by logged in users cannot be viewed.
- The names of confidential documents are not displayed.

<Job History of [Print]>

Item	Description
List items	No.: Job identification number assigned when the job is queued. User Name: Displays the user name or user name/account name of the user who stored the document. Document Name: File name being printed. Time Stored: Displays the time that the job was queued. Org.: Displays the number of pages in the original. Copies: Displays the number of copies to be printed. Result: Displays the result of the operation (completed successfully/deleted due to error/deleted by user/part of mode cancelled).
[↑] [↓]	When there are more than the upper limit of seven jobs to be displayed at one time, press these buttons to display other jobs.
[Deleted Jobs]/[Finished Jobs]/[All Jobs]	Switch to display the job type.
[Detail]	Press this button to check the job result, error details, registration source/user name, file name, output tray, stored time, number of original pages and number of copies for the selected job.
[Scanned Image]	Select the job to display the scanned image.

Reference

- When user authentication settings are applied, the names of documents that have not been saved by logged in users cannot be viewed.
- The names of confidential documents are not displayed.
- To view scanned images, you must set "Job History Thumbnail Display" to "ON" in Administrator Settings in advance. For details, refer to the [User's Guide Copy Operations].

<Current Jobs of [Send]>

Item	Description
List items	No.: Job identification number assigned when the job is queued. Address Type: Displays the destination type (including fax, E-Mail, FTP, PC (SMB), WebDAV, and TWAIN). "TWAIN" appears for the job that is sent via Web service. Status: Displays the status of the job (sending/queued/dialing/pending for redial/deleting). Address: Displays the fax number, E-mail address, User Box name, etc. of the recipient's machine. Time Stored: Displays the time that the job was queued. Org.: Displays the number of pages in the original.
[↑] [↓]	When there are more than the upper limit of seven jobs to be displayed at one time, press these buttons to display other jobs.
[Timer TX Job]	Displays the status of the reserved transmission in the memory. To delete a job, press [Delete].
[L1][L2]	These buttons appear when two fax kits are installed. Press one of these buttons. The job list of the selected line appears.
[Delete]	Press this button to delete the selected job.
[Redial]	Select a job of which the status is set to "Waiting To Redial", to perform redialing.
[Check Job Set.]	Press this button to check the settings of the selected job. Press either [← Back] or [Forward →] to check the settings.

Item	Description
[Detail]	<p>Press this button to check the registration source/user name, file name, destination type, destination, stored time, transmission, number of original pages and external server information for the selected job. To delete a job, press [Delete].</p> <ul style="list-style-type: none"> The external server information that is available by pressing [Details] appears only when using external server authentication. [Communication] is displayed only when the destination is a fax, Internet fax, or IP address fax.

Reference

- When user authentication settings are applied, the names of documents that have not been saved by logged in users cannot be viewed.
- The names of confidential documents are not displayed.

<Job History of [Send]>

Item	Description
List items	<p>No.: Job identification number assigned when the job is queued.</p> <p>Address Type: Displays the destination type (including fax, E-Mail, FTP, PC (SMB), WebDAV, and TWAIN). "TWAIN" appears for the job that is sent via Web service.</p> <p>Address: Displays the fax number, E-mail address, User Box name, etc. of the recipient's machine.</p> <p>Time Stored: Displays the time that the job was queued.</p> <p>Org.: Displays the number of pages in the original.</p> <p>Result: Displays the result of the operation (completed successfully/deleted due to error/deleted by user). "Error" is also displayed for broadcasting.</p>
[↑][↓]	When there are more than the upper limit of seven jobs to be displayed at one time, press these buttons to display other jobs.
[Deleted Jobs]/[Finished Jobs]/[All Jobs]	Switch to display the job type.
[Comm. List]	Displays the list of scanner and fax transmission (sent/received) jobs. You can print Activity Report, TX Report and RX Report in respective list screens.
[Detail]	<p>Press this button to check the result, error details, registration source/user name, file name, destination type, destination, stored time, transmission, number of original pages and external server information for the selected job.</p> <ul style="list-style-type: none"> The external server information that is available by pressing [Details] appears only when using external server authentication. [Communication] is displayed only when the destination is a fax, Internet fax, or IP address fax.
[Scanned Image]	Select the job to display the scanned image.

Reference

- When user authentication settings are applied, the names of documents that have not been saved by logged in users cannot be viewed.
- The names of confidential documents are not displayed.
- To view scanned images, you must set "Job History Thumbnail Display" to "ON" in Administrator Settings in advance. For details, refer to the [User's Guide Copy Operations].

<Current Jobs of [Receive]>

Item	Description
List items	No.: Job identification number assigned when the job is queued. User Name: Displays the user name or user name/account name of the user who stored the document. Status: Displays the status of the job (receiving/dialing (Polling RX)/queued/printing/printing stopped/print error/saving to memory/deleting). Document Name: Displays the name of the received or saved document. Time Stored: Displays the time that the job was queued. Org.: The number of original pages that were received.
[↑][↓]	When there are more than the upper limit of seven jobs to be displayed at one time, press these buttons to display other jobs.
[Delete]	Press this button to delete the selected job.
[Redial]	Select a job of which the status is set to "Waiting To Redial", to perform redialing.
[Forward]	Forwards the fax received and stored in the memory (in-memory proxy reception). Specify the recipients either by selecting destinations registered in the address book or by entering directly.
[Detail]	Press this button to check the registration source/user name, file name, output tray, stored time, transmission time, and number of original pages for the selected job. To delete a job, press [Delete].

Reference

- When user authentication settings are applied, the names of documents that have not been saved by logged in users cannot be viewed.
- The names of confidential documents are not displayed.

<Job History of [Receive]>

Item	Description
List items	No.: Job identification number assigned when the job is queued. User Name: Displays the user name or user name/account name of the user who stored the document. Document Name: Displays the name of the received or saved document. Time Stored: Displays the time that the job was queued. Org.: Displays the number of pages in the original. Result: Displays the result of the operation (Job Complete/Deleted Due To Error/Deleted by User/Reset Some Modes).
[↑][↓]	When there are more than the upper limit of seven jobs to be displayed at one time, press these buttons to display other jobs.
[Deleted Jobs]/[Finished Jobs]/[All Jobs]	Switch to display the job type.
[Comm. List]	Displays the list of scanner and fax transmission (sent/received) jobs. You can print Activity Report, TX Report and RX Report in respective list screens.
[Detail]	Press this button to check the job result, error details, registration source/user name, file name, output tray, stored time and number of original pages for the selected job.
[Received Image]	Select the job to display the received image.

Reference

- When user authentication settings are applied, the names of documents that have not been saved by logged in users cannot be viewed.
- The names of confidential documents are not displayed.
- To view received images, you must set "Job History Thumbnail Display" to "ON" in Administrator Settings in advance. For details, refer to the [User's Guide Copy Operations].

<Current Jobs of [Save]>

Item	Description
List items	No.: Job identification number assigned when the job is queued. User Name: Displays the user name or user name/account name of the user who stored the document. Status: Displays the status of the job (receiving, saving to memory, deleting). Document Name: Displays the name of the saved document. Time Stored: Displays the time that the job was queued. Org.: Displays the number of pages in the original.
[↑] [↓]	When there are more than the upper limit of seven jobs to be displayed at one time, press these buttons to display other jobs.
[Delete]	Press this button to delete the selected job.
[Detail]	Press this button to check the registration source/user name, file name, User Box, stored time, and number of original pages for the selected job. To delete a job, press [Delete].

Reference

- When user authentication settings are applied, the names of documents that have not been saved by logged in users cannot be viewed.
- The names of confidential documents are not displayed.

<Job History of [Save]>

Item	Description
List items	No.: Job identification number assigned when the job is queued. User Name: Displays the user name or user name/account name of the user who stored the document. Document Name: Displays the name of the saved document. Time Stored: Displays the time that the job was queued. Org.: Displays the number of pages in the original. Result: Displays the result of the operation (Job Complete/Deleted Due To Error/Deleted by User/Reset Some Modes).
[↑] [↓]	When there are more than the upper limit of seven jobs to be displayed at one time, press these buttons to display other jobs.
[Deleted Jobs]/[Finished Jobs]/[All Jobs]	Switch to display the job type.
[Comm. List]	Displays the list of scanner and fax transmission (sent/received) jobs. You can print Activity Report, TX Report and RX Report in respective list screens.
[Detail]	Press this button to check the result, error details, registration source/user name, file name, destination User Box, stored time and number of original pages for the selected job.
[Saved Image]	Select the job to display the saved image.

Reference

- When user authentication settings are applied, the names of documents that have not been saved by logged in users cannot be viewed.
- The names of confidential documents are not displayed.
- To view saved images, you must set "Job History Thumbnail Display" to "ON" in Administrator Settings in advance. For details, refer to the [User's Guide Copy Operations].

User Box information

Displays the User Box information when you select a User Box.

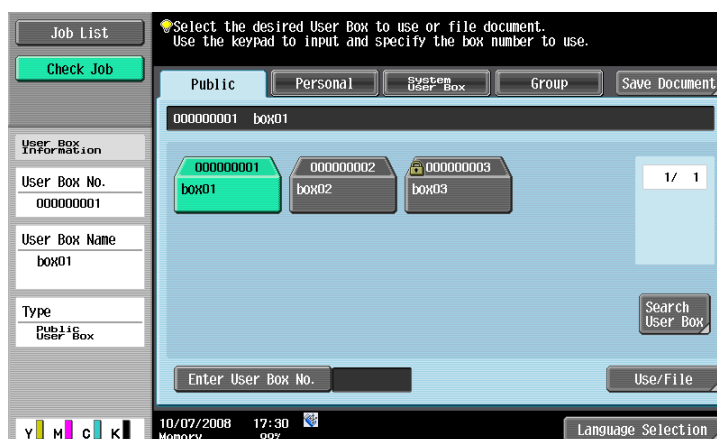

Use/File - Detail

Press [Detail] on the lower left of the Use Document screen to check the time stored, user name, document name, the number of pages, and job number of the selected document. Press [Preview] to check the preview image of the saved document.

Reference

- When you select multiple documents, use [↑][↓] to switch pages.

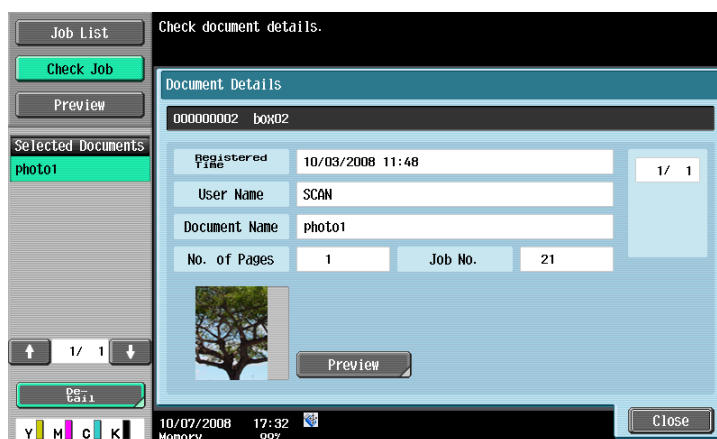

Reference

For checking preview image, refer to page 3-14.

Use/File - Check Job Settings

Select [Send] or [Bind TX] in the Send tab to display the address entry screen. [Check Job Settings] is displayed on the lower left of the screen.

Reference

- Press [Check Job Settings] to check the following settings.
 - Destination Settings
 - Document Setting Contents
 - Communication Settings (Not displayed when Combine is enabled.)
 - Check E-Mail Settings

Use/File - Check Job Settings - Destination Settings

Displays the list of destinations that are registered in the machine.

Reference

- To add a directly entered destination to the address book, select the destination, and press [Store Address].
- To check the detailed information of the destination, select a destination, and press [Details].
- To delete a destination, select one you want to delete, and then press [Delete].



Reference

For details on how to register a destination to the address book, refer to the [User's Guide Network Scan/Fax/Network Fax Operations].

Use/File - Check Job Settings - Document Setting Contents

View the list of resolution, file type, and color settings.

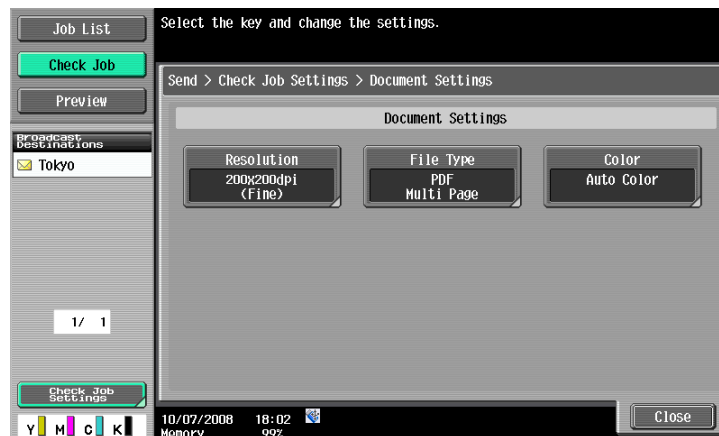

Use/File - Check Job Settings - Communication Settings

You can check the line settings and communication method settings. Press either [← Back] or [Forward →] to check the settings.

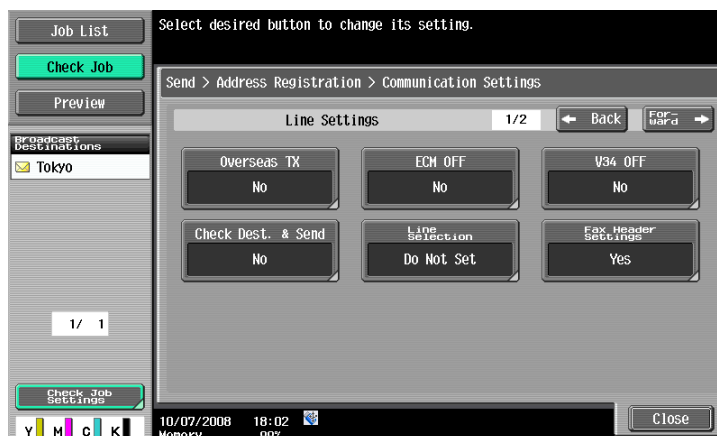

Use/File - Check Job Settings - Check E-Mail Settings

Check the document name, subject, From address and message body to send E-mail messages.

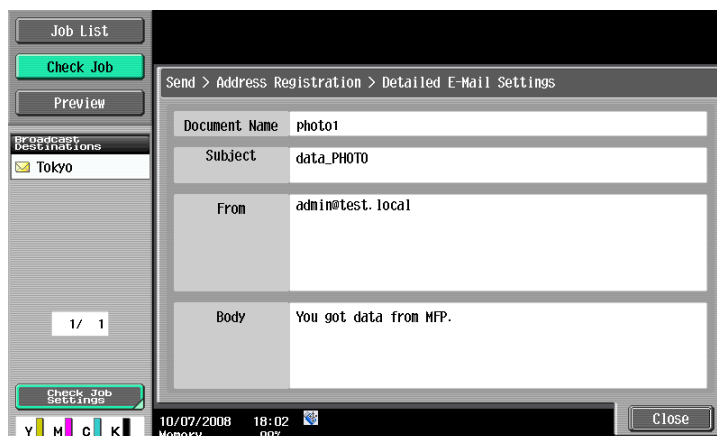

Preview

Check the preview image of the selected document when using or filing documents. Press [Preview] to select one document. The image of the first page is displayed in the left panel.

Reference

- For a document with multiple pages, only the image of the first page can be viewed.



Preview

Press [Detail] to enlarge the preview image.

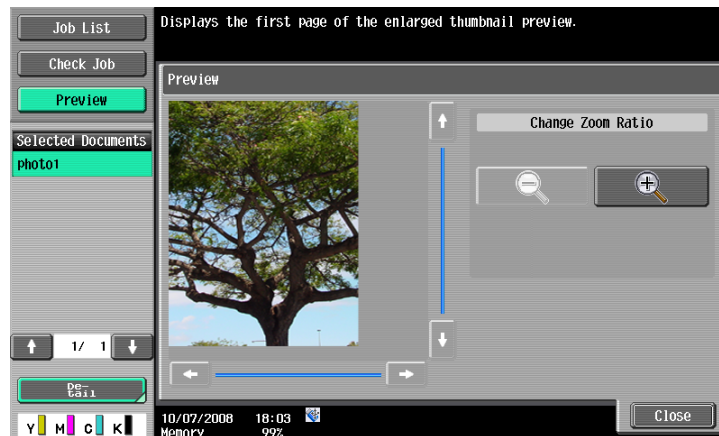

Enlarge the image of the document to check details. The image can be magnified 2 times, 4 times or 8 times. To view the desired portion of the enlarged image, use the scroll bars located in the right and the bottom of the image.

Preview (Print/Combine)

Preview the page image of printing result by pressing the [Preview] - [Detail] in the left panel when you have selected [Print] or [Combine].

Reference

- For a document with multiple pages, images of all pages can be viewed.



Item	Description
[← Prev. Page]/ [Next Page →]	If the saved document contains multiple pages, use these buttons to switch the display to another page.
[Zoom]	Enlarge the image of the document to check details. The image can be magnified 2 times, 4 times or 8 times. To view the desired portion of the enlarged image, use the scroll bars located in the right and the bottom of the image.
[Rotate Image]	 : Rotates the currently displayed page by 180 degrees to show the image. [Rotate Pages]: Select if the saved document contains multiple pages. <ul style="list-style-type: none"> • You can select multiple images in the page to be rotated. • [Odd Page]: Select images in the odd numbered pages. • [Even Page]: Select images in the even numbered pages. • [Select All]: Select images in all pages. • [Rotation Angle]: Click [180°] to rotate a page.
[View Finishing]	Displays the specified settings as icons and text in the preview image. Cancel [View Finishing] to erase the icons and text so that only the image appears in the screen.

Preview (Send/Bind TX)

Preview the page image of sending result by pressing the [Preview] - [Detail] in the left panel when you have selected [Send] or [Bind TX].



Item	Description
[Scan]	Displays the preview for E-mail TX/PC (FTP)/File TX (SMB)/File TX (WebDAV) operations.
[Fax]	Press this button to display the preview for G3 fax, IP address fax, or Internet fax operations.
[← Prev. Page]/ [Next Page →]	If the saved document contains multiple pages, use these buttons to switch the display to another page.
[Zoom]	Enlarge the image of the document to check details. The image can be magnified 2 times, 4 times or 8 times. To view the desired portion of the enlarged image, use the scroll bars located in the right and the bottom of the image.
[Rotate Image]	<p>When [Scan] is selected in [Preview]</p> <p> : Rotates the currently displayed page 90 degrees anti-clockwise to show the image.</p> <p> : Rotates the currently displayed page 90 degrees clockwise to show the image.</p> <p>[Rotate Pages]: Select if the saved document contains multiple pages.</p> <ul style="list-style-type: none"> You can select multiple images in the page to be rotated. [Odd Page]: Select images in the odd numbered pages. [Even Page]: Select images in the even numbered pages. [Select All]: Select images in all pages. [Rotation Angle]: Select [Left 90°], [Right 90°], or [180°] as the rotation angle. <p>When the destination is a fax, an image is sent at 180 degrees if [Left 90°] is selected in [Rotation Angle] and at 0 degrees if [Right 90°] is selected.</p> <p>If TIFF or JPEG is selected as the file format to read a long original, the rotation mode may not be specified.</p> <p>When [Fax] is selected in [Preview]</p> <p> : Rotates the currently displayed page by 180 degrees to show the image.</p> <p>[Rotate Pages]: Select if the saved document contains multiple pages.</p> <ul style="list-style-type: none"> You can select multiple images in the page to be rotated. [Odd Page]: Select images in the odd numbered pages. [Even Page]: Select images in the even numbered pages. [Select All]: Select images in all pages. [Rotation Angle]: Click [180°] to rotate a page.
[Delete Page]	<p>Displayed when the saved document contains multiple pages while [Send] is selected.</p> <p>You can select multiple images in the page to be deleted.</p> <p>[Odd Page]: Select images in the odd numbered pages.</p> <p>[Even Page]: Select images in the even numbered pages.</p> <p>All pages cannot be deleted.</p>
[View Finishing]	View the finishing image with the configured settings, including printing the data, applied. When you cancel [View Finishing], only the image appears in the screen.

Reference

- If you select [Bind TX], the Delete Page function becomes unavailable.
- If you select [Send] for multiple documents, the rotate page and delete page functions become unavailable.

4

User Box Operation Flow

4 User Box Operation Flow

4.1 Saving documents in User Boxes

This section describes the steps for saving documents in Public User Boxes.

Press the **User Box** key in the control panel

User Box

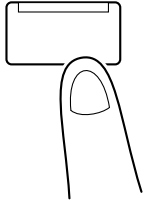

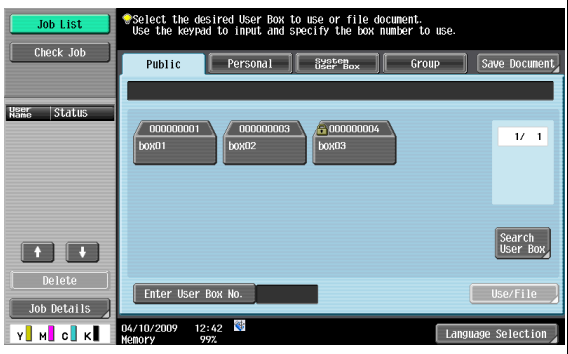

Select the desired User Box, and then press [Save Document]





Configure the document name (p. 6-5), scan settings (p. 6-6) and original settings (p. 6-19)

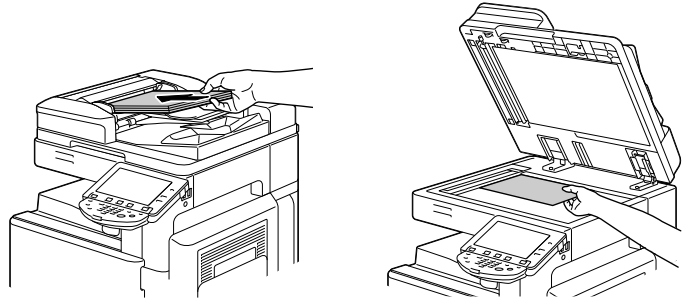

Load the original

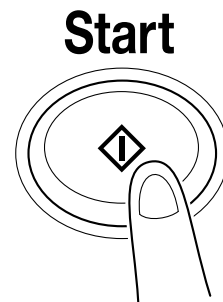

Press [Start] or the **Start** key in the control panel



Reference

- When saving an original with an embedded password, the password entry screen appears. Enter the password and press [OK] to start saving.
- You cannot save an original with copy guard embedded.

4.2 Printing documents from a User Box

This section describes the steps for printing documents saved in Public User Boxes.

Press the **User Box** key in the control panel

User Box

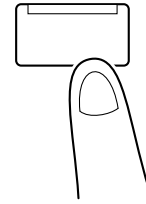

Select the desired User Box, and then press [Use/File]

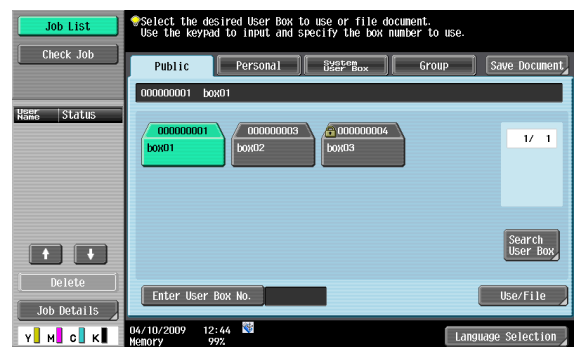

Select the [Print] tab



Select documents



If you have selected a single document, press [Print] (p. 7-6)

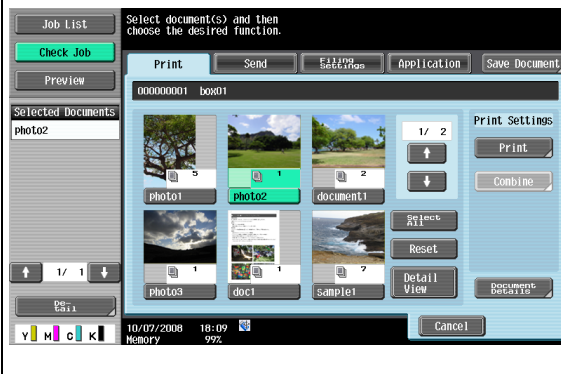

When selecting multiple documents and printing them using added functions, press [Combine] (p. 7-7)

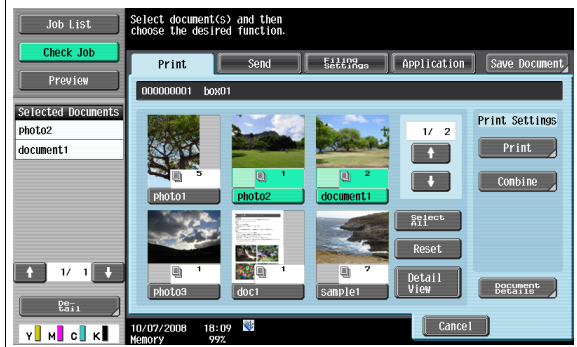

Configure the printing order (bind order) (p. 7-8)

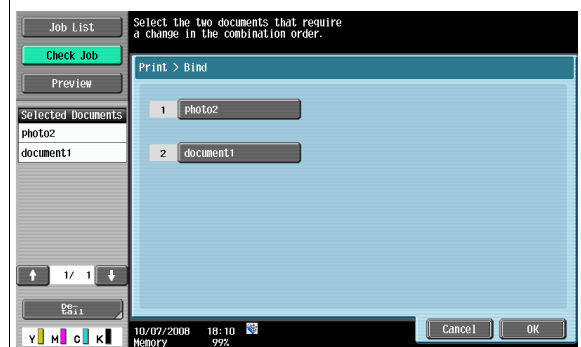

Configure basic and application settings (p. 7-9, p. 7-17)



Configure basic and application settings (p. 7-9, p. 7-17)

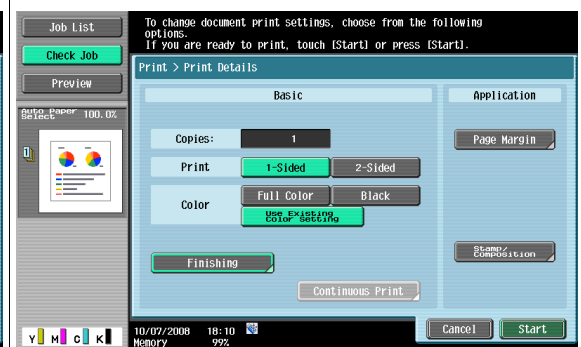

To confirm the contents, display the preview (p. 3-15)

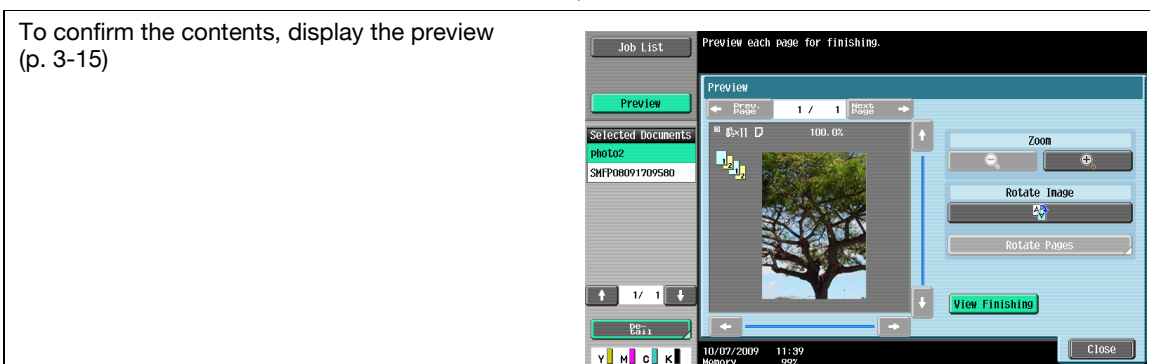



Press [Start] or the **Start** key in the control panel

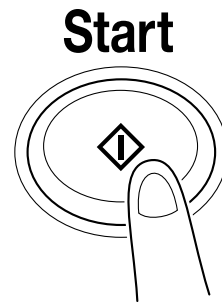

4.3 Sending documents from a User Box

This section describes the steps for sending documents saved in Public User Boxes.

Press the **User Box** key in the control panel

User Box

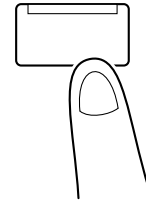

Select the desired User Box, and then press [Use/File]

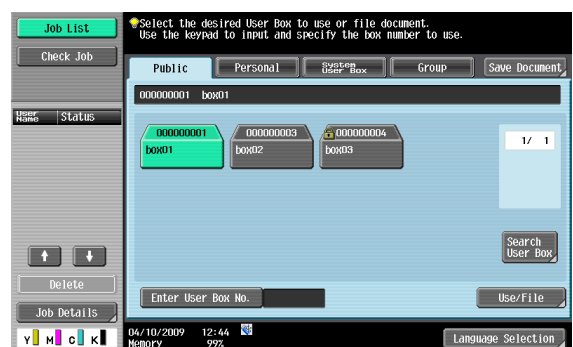

Select the [Send] tab



Select documents



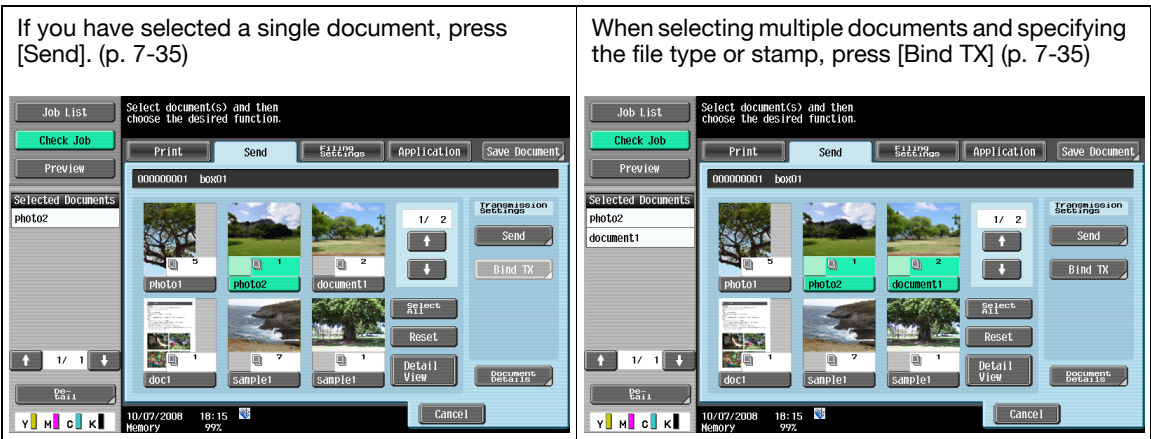

Configure the sending order (bind order) (p. 7-8)

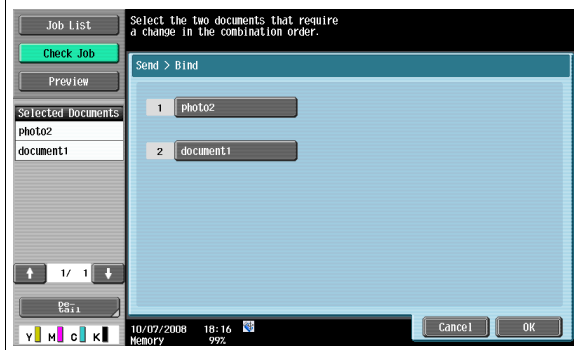

Specify the destination

Address Book	Direct Input	Job History (The job history of fax, Internet fax, or IP address fax is not displayed when Bind TX is selected.)	Address Search

Also specify a scan/fax program. For details on scan/fax programs, refer to the [User's Guide Network Scan/Fax/Network Fax Operations].



Configure document, communication, and application settings (p. 7-49)

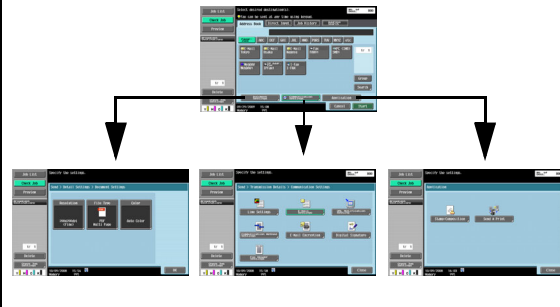

Configure document, communication, and application settings (p. 7-49)

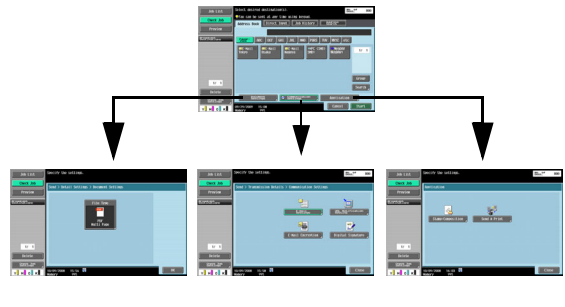

To confirm the contents, display the preview (p. 3-16)

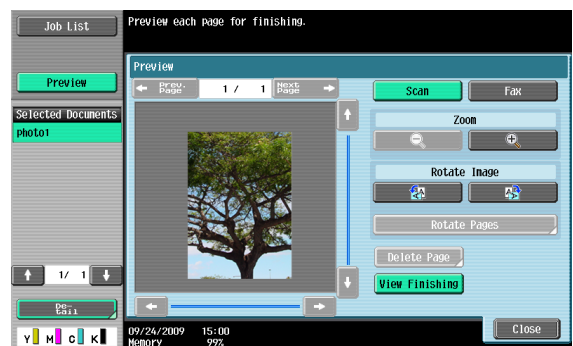

Press [Start] or the **Start** key in the control panel

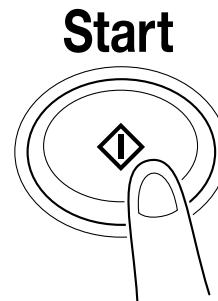

4.4 Saving a document in an external memory

This section describes the steps for saving scanned images in the external memory.

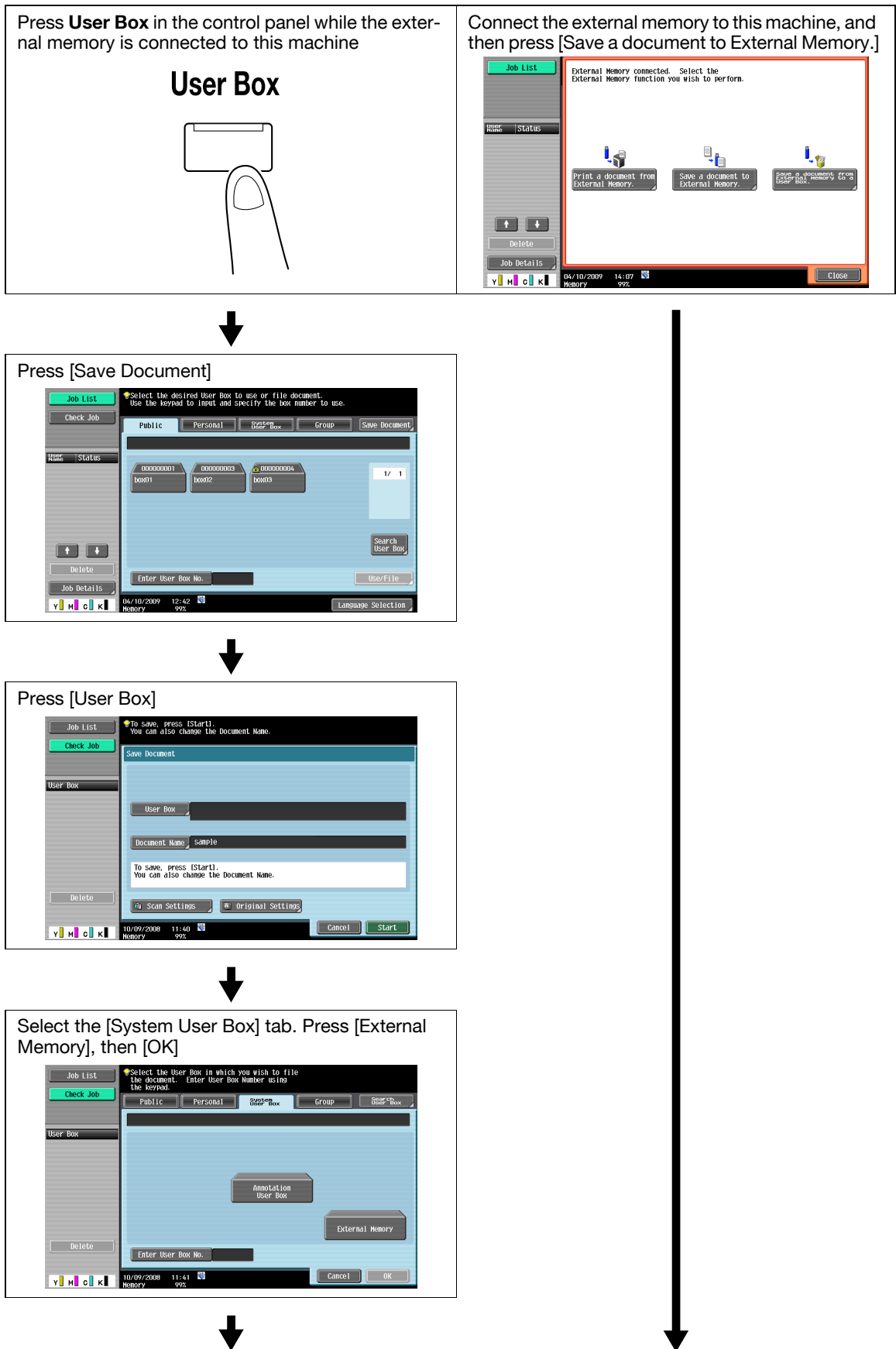

Configure the document name (p. 6-5), scan settings (p. 6-6) and original settings (p. 6-19)

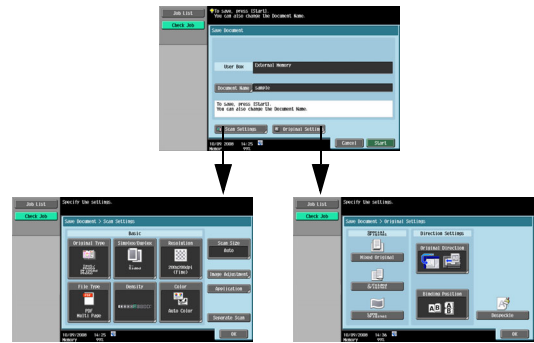

Load the original

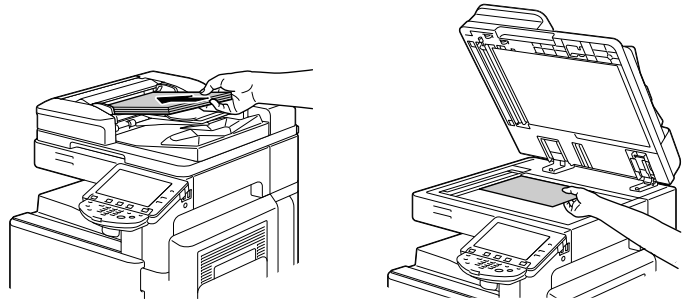

Press [Start] or the **Start** key in the control panel

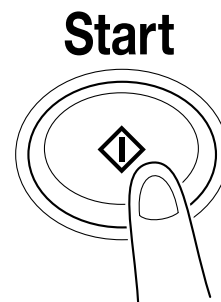

Reference

- When saving an original with an embedded password, the password entry screen appears. Enter the password and press [OK] to start saving.
- You cannot save an original with copy guard embedded.
- A function to save a document in external memory is set to OFF (not saved) in the factory setting. In addition, it is set to OFF (cannot be saved) by the user function settings when user authentication is enabled. To save a document in external memory, change the setting to enable you to save a document in Administrator Settings. For details, refer to page 8-23.

4.5 Saving a Document from the External Memory into a User Box

This section describes the steps for saving a document stored in the external memory to a User Box.

Press **User Box** in the control panel while the external memory is connected to this machine

User Box

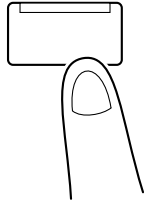

Connect the external memory to this machine, and then press [Save a document from External Memory to a User Box.]

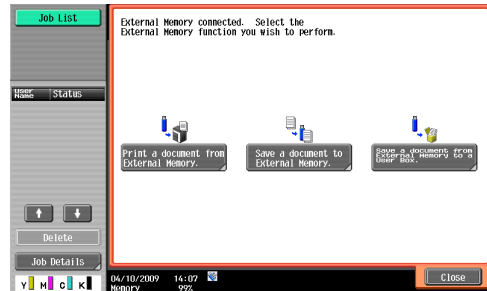

Select the [System User Box] tab. Press [External Memory], then [Use/File]

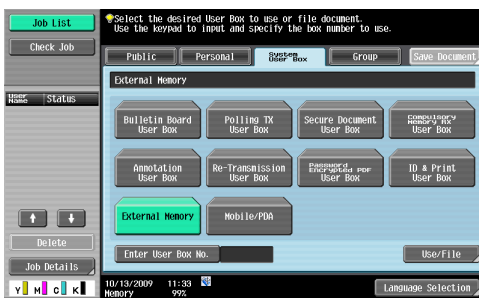

Press the [Filing Settings] tab

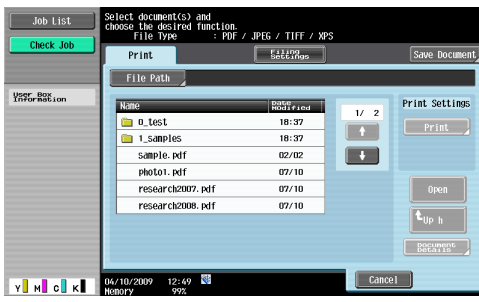

Select a document, and then press [Save to User Box]

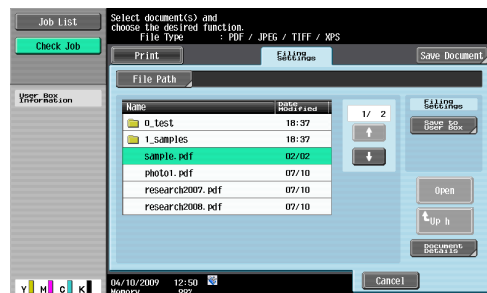

Specify the User Box and document name
(p. 7-104)

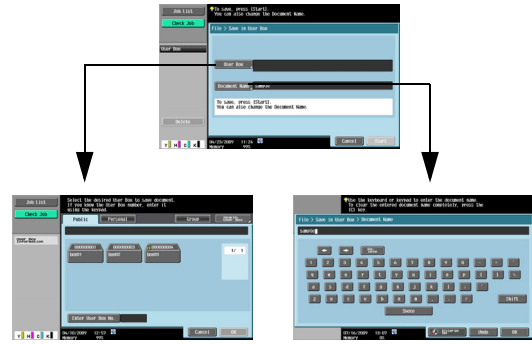

Press [Start] or the **Start** key in the control panel

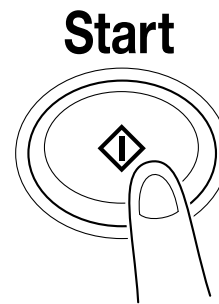

Reference

- A function to save documents from an external memory into a User Box is set to OFF (cannot be saved) by factory default. In addition, it is set to OFF (cannot be saved) by the user function settings when user authentication is enabled. To save a document from the external memory into a User Box, change the setting to enable you to save a document in Administrator Settings. For details, refer to page 8-23.

4.6 Printing a document from an external memory

This section describes the steps for printing documents saved in the external memory.

Press **User Box** in the control panel while the external memory is connected to this machine

User Box

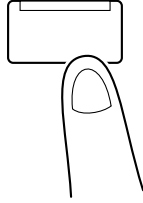

Connect the external memory to this machine, and then press [Print a document from External Memory.]

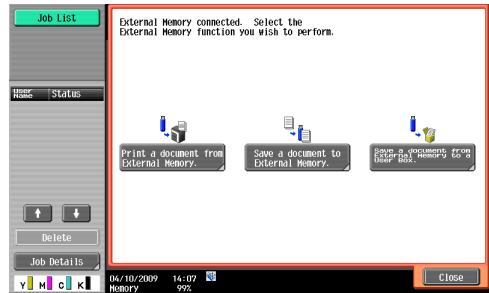

Select the [System User Box] tab, and then press [External Memory]

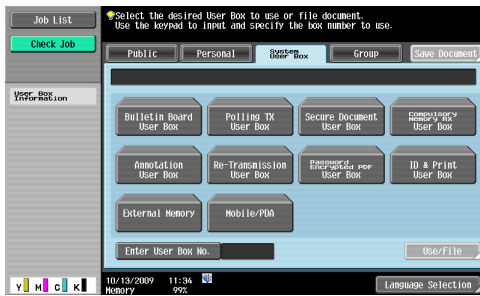

Press [Use/File]

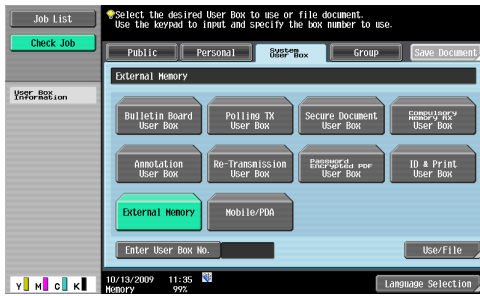

Select a file, and then press [Print] (p. 7-101)

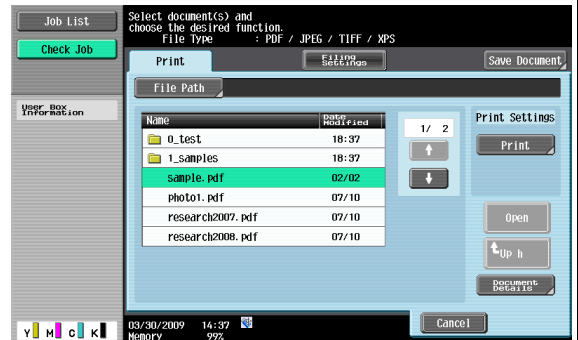

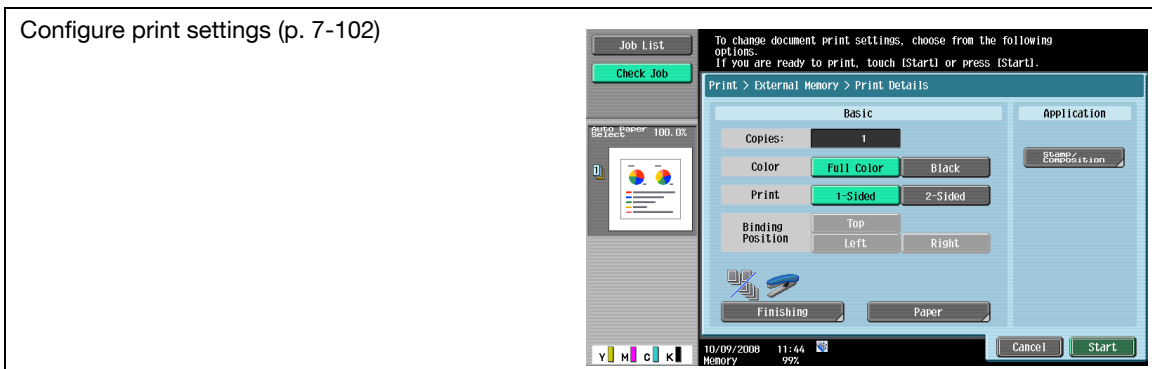

Press [Start] or the **Start** key in the control panel

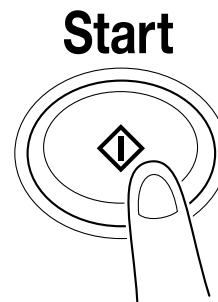

Reference

- Depending on the settings in Administrator Settings, you may not be able to print a document located in an external memory. To print a document located in an external memory, change the setting to enable you to print a document in Administrator Settings. For details, refer to page 8-23.

4.7 Filing documents in a User Box

This section describes the steps for filing documents saved in Public User Boxes.

Press the **User Box** key in the control panel

User Box

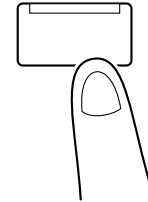

Select the desired User Box, and then press [Use/File]

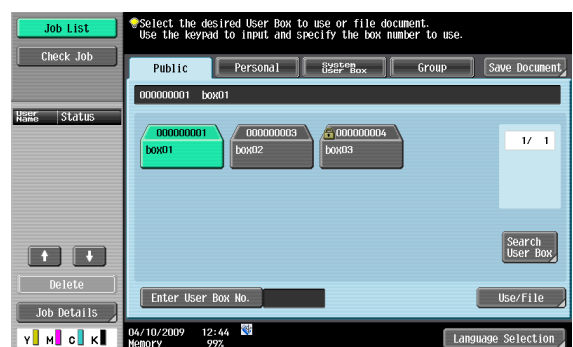

Select the [Filing Settings] tab



Select documents, and then select a function (p. 7-65)



**Reference**

To delete the documents, refer to page 7-66.

To rename the documents, refer to page 7-66.

To move the documents to other User Boxes, refer to page 7-66.

To copy the documents to other User Boxes, refer to page 7-67.

To save a document in the external memory, refer to page 7-67.

To check information of the documents or preview the documents, refer to page 7-70.

4.8 Printing a Document Saved in a Cellular Phone or PDA

This section describes the steps to print a document saved in a cellular phone or PDA.

Press the **User Box** key in the control panel

User Box

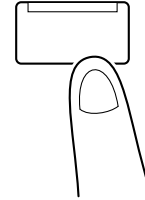

Select the [System User Box] tab. Press [Mobile/PDA], then [Use/File]

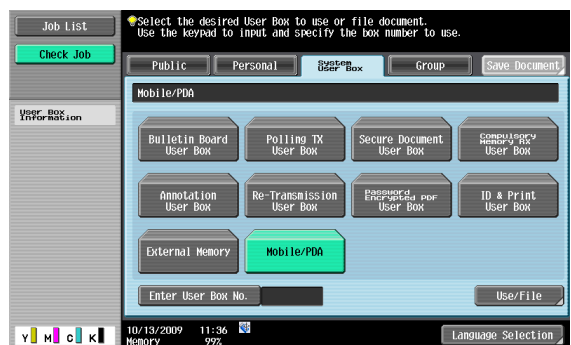

Press [Print List]

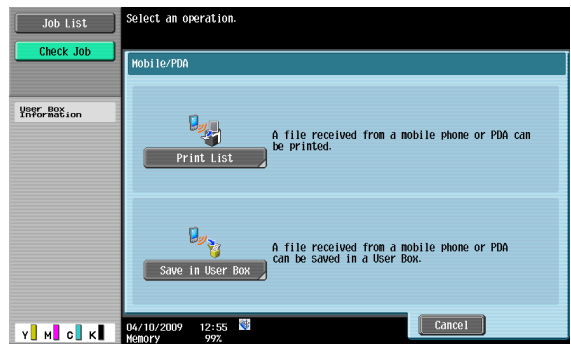

To check printing preferences, press [Check Print Settings]

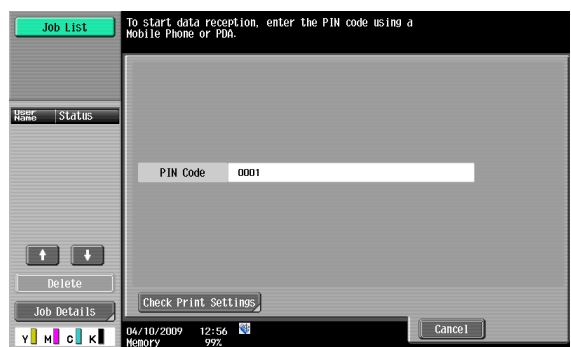

Enter the PIN code displayed in the control panel to the cellular phone or PDA (p. 7-105)

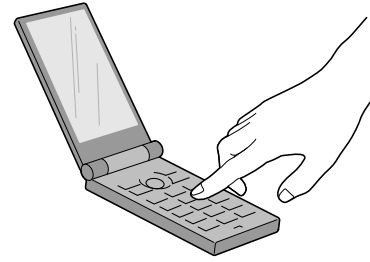
**Reference**

To configure print settings from a cellular phone or PDA, refer to page 8-12.

4.9 Saving a Document Stored in a Cellular Phone or PDA to a User Box

This section describes the steps to save a document stored in a cellular phone or PDA to a User Box.

Press the **User Box** key in the control panel

User Box

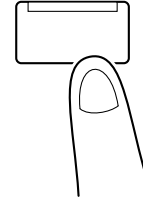

Select the [System User Box] tab. Press [Mobile/PDA], then [Use/File]

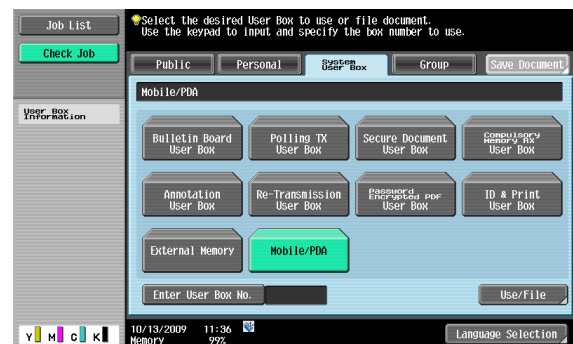

Press [Save in User Box]

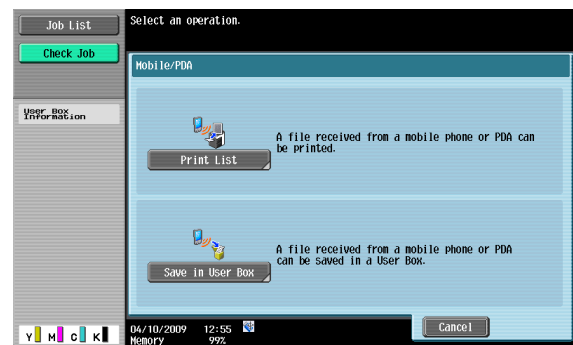

Select the desired User Box, and then press [OK]

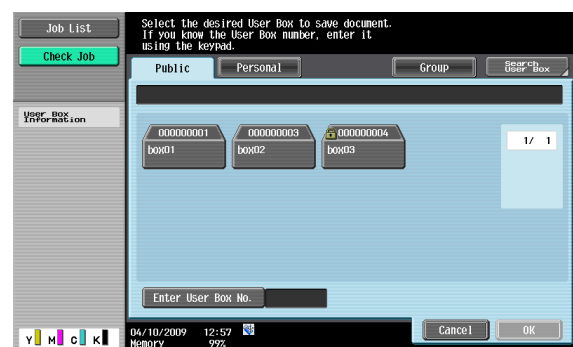

Enter the PIN code displayed in the control panel to the cellular phone or PDA (p. 7-106)

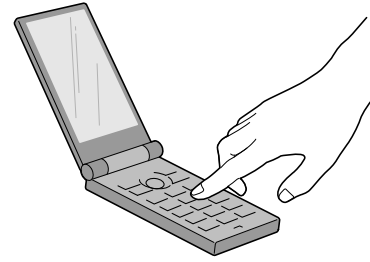

4.10 Menu tree of the User Box mode

This section describes the configuration and settings for the functions available in the User Box mode.

4.10.1 Save Document

Public, Personal, or Group User Box

The following shows the menu tree for saving documents in Public, Personal, or Group User Boxes.

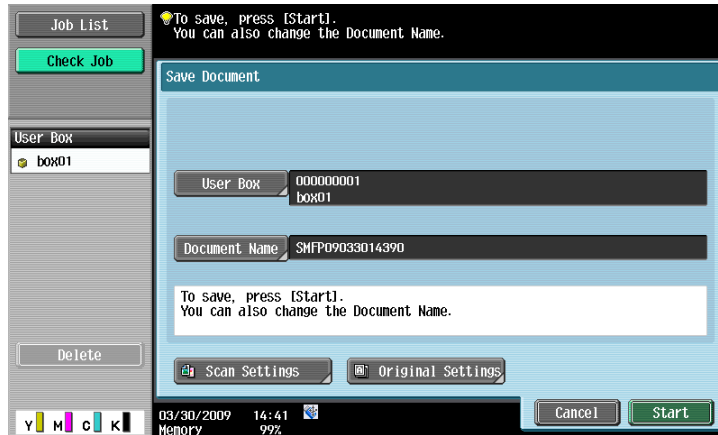

First level	Second level	Third level	Fourth level
[User Box] (p. 6-5)			
[Document Name] (p. 6-5)			
[Scan Settings]	[Original Type] (p. 6-6)		
	[Simplex/Duplex] (p. 6-7)		
	[Resolution] (p. 6-7)		
	[File Type]	[File Type] (p. 6-8)	
		[Encryption] (p. 6-9)	
		[Outline PDF] (p. 6-11)	
		[Scan Setting] (p. 6-11)	
	[Density] (p. 6-12)		
	[Color] (p. 6-12)		
	[Scan Size] (p. 6-13)		
	[Image Adjustment]	[Background Removal] (p. 6-14)	
		[Sharpness] (p. 6-15)	
	[Application]	[Frame Erase] (p. 6-15)	
		[Book Copy] (p. 6-16)	
	[Separate Scan] (p. 6-18)		
[Original Settings]	[Special Original] (p. 6-19)	[Mixed Original]	
		[Z-Folded Original]	
		[Long Original]	
	[Direction Settings]	[Original Direction] (p. 6-19)	
		[Binding Position] (p. 6-20)	[Auto]
			[Top]
			[Left]
	[Despeckle] (p. 6-20)		

System User Box

The following shows the menu tree for saving documents in System User Boxes.

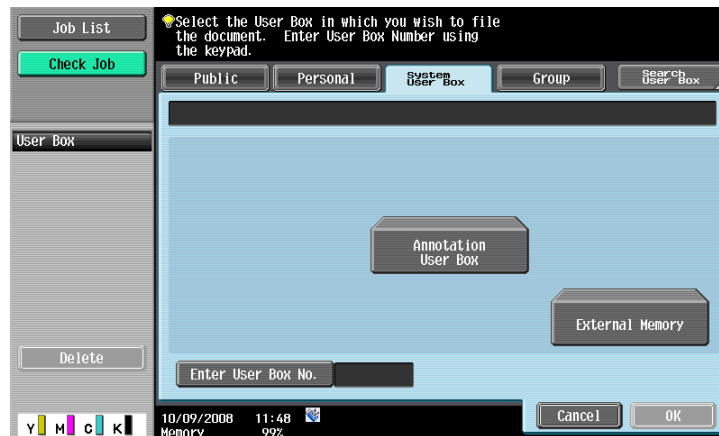

First level	Second level	Third level	Fourth level	
[Annotation User Box]	[User Box] (p. 6-5)			
	[Document Name] (p. 6-5)			
	[Scan Settings]	[Original Type] (p. 6-6)		
		[Simplex/Duplex] (p. 6-7)		
		[Resolution] (p. 6-7)		
		[File Type]	[File Type] (p. 6-8)	
			[Encryption] (p. 6-9)	
			[Outline PDF] (p. 6-11)	
			[Scan Setting] (p. 6-11)	
		[Density] (p. 6-12)		
		[Color] (p. 6-12)		
		[Scan Size] (p. 6-13)		
		[Image Adjustment]	[Background Removal] (p. 6-14)	
			[Sharpness] (p. 6-15)	
		[Application]	[Frame Erase] (p. 6-15)	
			[Book Copy] (p. 6-16)	
		[Separate Scan] (p. 6-18)		
		[Original Settings]	[Special Original] (p. 6-19)	[Mixed Original]
				[Z-Folded Original]
				[Long Original]
	[Direction Settings]	[Original Direction] (p. 6-19)		
		[Binding Position] (p. 6-20)		
	[Despeckle] (p. 6-20)			

First level	Second level	Third level	Fourth level	
[External Memory]	[User Box] (p. 6-5)			
	[Document Name] (p. 6-5)			
	[Scan Settings]	[Original Type] (p. 6-6)		
		[Simplex/Duplex] (p. 6-7)		
		[Resolution] (p. 6-7)		
		[File Type]	[File Type] (p. 6-8)	
			[Encryption] (p. 6-9)	
			[Outline PDF] (p. 6-11)	
			[Scan Setting] (p. 6-11)	
		[Density] (p. 6-12)		
		[Color] (p. 6-12)		
		[Scan Size] (p. 6-13)		
		[Image Adjustment]	[Background Removal] (p. 6-14)	
			[Sharpness] (p. 6-15)	
		[Application]	[Frame Erase] (p. 6-15)	
			[Book Copy] (p. 6-16)	
	[Separate Scan] (p. 6-18)			
	[Original Settings]	[Special Original] (p. 6-19)	[Mixed Original]	
			[Z-Folded Original]	
			[Long Original]	
[Direction Settings]		[Original Direction] (p. 6-19)		
		[Binding Position] (p. 6-20)		
[Despeckle] (p. 6-20)				
[Mobile/PDA]	[Save in User Box] (p. 7-105)			

4.10.2 Use/File

Print (for Public/Personal/Group User Boxes)

The following shows the menu tree for using or filing documents in Public, Personal, or Group User Boxes, and configuring print settings. The following describes items available using the framed buttons.



First level	Second level	Third level	Fourth level
[Print]	[Copies] (p. 7-9)		
	[Print] (p. 7-9)	[1-Sided]	
		[2-Sided]	
	[Color] (p. 7-10)	[Full Color]	
		[Black]	
		[Use Existing Color Setting]	
	[Finishing] (p. 7-10)	[Sort] (p. 7-11)	
		[Group] (p. 7-11)	
		[Offset] (p. 7-11)	
		[Staple] (p. 7-11)	
		[Punch] (p. 7-11)	
		[Fold/Bind] (p. 7-12)	[Half-Fold]
			[Center Staple & Fold]
			Tri-Fold
			Z-Fold
	[Combine] (p. 7-14)	[Combine Pages]	
		[Combine Direction]	
	[Zoom] (p. 7-15)	[Existing Setting]	
		[Manual]	
		[Full Size]	
		[Minimal]	
		[Fixed Zoom]	
		[User Preset Zoom]	

First level	Second level	Third level	Fourth level	
[Print]	[Page Margin] (p. 7-17)	[Margin Position]		
		[Adjust Value]		
		[Image Shift] (p. 7-17)	[Vertical Shift]	
			[Horizontal Shift]	
	[Change Back Shift]			
	[Sheet/Cover/Chapter Insert]	[Cover Sheet] (p. 7-19)	[Front Cover]	
			[Back Cover]	
		[Insert Sheet] (p. 7-20)	[Insert Paper]	
			[Insert Type]	
		[Chapters] (p. 7-21)	[Chapter Paper]	
		[Stamp/Composition] (p. 7-22)	[Date/Time] (p. 7-22)	[Date Format]
	[Time Format]			
	[Pages]			
	[Print Position]			
	[Text Details]			
	[Page Number] (p. 7-23)		[Starting Page Number]	
			[Page Number Type]	
			[Starting Chapter Number]	
			[Insert Sheet Setting] (p. 7-24)	
			[Print Position]	
			[Text Details]	
[Stamp] (p. 7-24)	[Stamp Type/Pre-set Stamps]			
	[Pages]			
	[Text Size]			
	[Text Color]			
	[Print Position]			
[Copy Security]	[Copy Protect] (p. 7-26)			
	[Copy Guard] (p. 7-27)			
	[Password Copy] (p. 7-28)			
[Stamp Repeat] (p. 7-30)	[Stamp Repeat Type] (p. 7-30)			
	[Detail Settings] (p. 7-31)			
	[Position] (p. 7-31)			

First level	Second level	Third level	Fourth level	
[Print]	[Stamp/Composition] (p. 7-22)	[Header/Footer] (p. 7-31)	[Recall Header/Footer]	
			[Mode Check]	
		[Registered Overlay] (p. 7-33)	[Recall Overlay Image]	
			[Pages]	
[Combine]	[Copies] (p. 7-9)			
	[Print] (p. 7-9)	[1-Sided]		
		[2-Sided]		
	[Color] (p. 7-10)	[Full Color]		
		[Black]		
		[Use Existing Color Setting]		
	[Finishing] (p. 7-10)	[Offset] (p. 7-11)		
		[Staple] (p. 7-11)		
		[Punch] (p. 7-11)		
		[Fold/Bind] (p. 7-12)	[Half-Fold]	
			[Center Staple & Fold]	
			Tri-Fold	
			Z-Fold	
	[Continuous Print] (p. 7-16)			
	[Page Margin] (p. 7-17)	[Margin Position]		
		[Adjust Value]		
[Image Shift] (p. 7-17)		[Vertical Shift]		
		[Horizontal Shift]		
		[Change Back Shift]		

First level	Second level	Third level	Fourth level
[Combine]	[Stamp/Composition]	[Date/Time] (p. 7-22)	[Date Format]
			[Time Format]
			[Pages]
			[Print Position]
			[Text Details]
		[Page Number] (p. 7-23)	[Starting Page Number]
			[Page Number Type]
			[Starting Chapter Number]
			[Print Position]
			[Text Details]
		[Stamp] (p. 7-24)	[Stamp Type/Preset Stamps]
			[Pages]
			[Text Size]
			[Text Color]
			[Print Position]
		[Copy Security] (p. 7-25)	[Copy Protect] (p. 7-26)
			[Copy Guard] (p. 7-27)
			[Password Copy] (p. 7-28)
		[Stamp Repeat] (p. 7-30)	[Stamp Repeat Type] (p. 7-30)
			[Detail Settings] (p. 7-31)
[Position] (p. 7-31)			
[Header/Footer] (p. 7-31)	[Recall Header/Footer]		
	[Mode Check]		
[Registered Overlay] (p. 7-33)	[Recall Overlay Image]		
	[Pages]		
[Document Details]	[Preview] (p. 7-70)		

Send (for Public/Personal/Group User Boxes)

The following shows the Use/File - Send menu tree for Public, Personal, or Group User Boxes. The following describes items available using the framed buttons.



First level	Second level	Third level	Fourth level
[Send]	[Address Book]	[Search] (p. 7-39)	
	[Direct Input]	[Fax] (p. 7-42)	[Fax Number]
		[E-Mail] (p. 7-42)	
		[Internet Fax] (p. 7-43)	[RX Ability (Destination)] (p. 7-43)
		[IP Address Fax] (p. 7-44)	[Address]
			[Port Number]
	[PC (SMB)] (p. 7-44)	[Destination Machine Type]	
		[Host Name]	
		[File Path]	
		[User Name]	
		[Password]	
		[Reference]	

First level	Second level	Third level	Fourth level
[Send]		[FTP] (p. 7-45)	[Host Name]
			[File Path]
			[User Name]
			[Password]
			[Detailed Settings]
		[WebDAV] (p. 7-46)	[Host Name]
			[File Path]
			[User Name]
			[Password]
			[Detailed Settings]
	[Job History] (p. 7-47)		
	[Address Search] (p. 7-47)	[Search] (p. 7-48)	
		[Advanced Search] (p. 7-48)	
	[Document Settings]	[Resolution] (p. 7-49)	
		[File Type] (p. 7-50)	[File Type] (p. 7-50)
[Encryption] (p. 7-51)			
[Stamp Composition] (p. 7-53)			
[Outline PDF] (p. 7-53)			
[Scan Setting] (p. 7-54)			
[Color] (p. 7-54)		[Use Existing Color Setting]	
		[Full Color]	
		[Gray Scale]	
		[Black]	
[Communication Settings]	[Line Settings] (p. 7-55)	[Overseas TX] (p. 7-55)	
		[ECM OFF] (p. 7-56)	
		[V.34 OFF] (p. 7-56)	
		[Check Dest. & Send] (p. 7-56)	
		[Select Line] (p. 7-56)	
	[E-Mail Settings] (p. 7-57)	[Document Name] (p. 7-57)	
		[Subject] (p. 7-57)	
		[From] (p. 7-58)	
	[URL Notification Setting] (p. 7-59)	[Body] (p. 7-58)	
		[Address Book]	
		[Detail Search]	
			[Direct Input]

First level	Second level	Third level	Fourth level
[Send]	[Communication Settings]	[Communication Method Settings] (p. 7-60)	[Timer TX] (p. 7-60)
			[Password TX] (p. 7-61)
			[F-Code TX] (p. 7-61)
		[E-Mail Encryption] (p. 7-62)	
		[Digital Signature] (p. 7-62)	
		[Fax Header Settings] (p. 7-62)	
	[Application]	[Stamp/Composition]	[Date/Time] (p. 7-22)
			[Page Number] (p. 7-23)
			[Stamp] (p. 7-24)
			[Header/Footer] (p. 7-31)
		[Send & Print] (p. 7-64)	[Copies]
			[Simplex/Duplex]
			[Staple]
	[Bind TX]	[Address Book]	[Search] (p. 7-39)
[Direct Input]		[E-Mail] (p. 7-42)	
		[PC (SMB)] (p. 7-44)	[Host Name]
			[File Path]
			[User Name]
			[Password]
			[Reference]
		[FTP] (p. 7-45)	[Host Name]
			[File Path]
			[User Name]
			[Password]
			[Detailed Settings]
		[WebDAV] (p. 7-46)	[Host Name]
			[File Path]
[User Name]			
[Password]			
[Detailed Settings]			
[Job History] (p. 7-47)			
[Address Search] (p. 7-47)	[Search] (p. 7-48)		
	[Advanced Search] (p. 7-48)		

First level	Second level	Third level	Fourth level
[Bind TX]	[Document Settings]	[File Type] (p. 7-50)	[File Type] (p. 7-50)
			[Encryption] (p. 7-51)
			[Stamp Composition] (p. 7-53)
			[Outline PDF] (p. 7-53)
			[Scan Setting] (p. 7-54)
	[Communication Settings]	[E-Mail Settings] (p. 7-57)	[Document Name] (p. 7-57)
			[Subject] (p. 7-57)
			[From] (p. 7-58)
			[Body] (p. 7-58)
		[URL Notification Setting] (p. 7-59)	[Address Book]
			[Detail Search]
			[Direct Input]
	[E-Mail Encryption] (p. 7-62)		
	[Digital Signature] (p. 7-62)		
[Application]	[Stamp/Composition]	[Date/Time] (p. 7-22)	
		[Page Number] (p. 7-23)	
		[Stamp] (p. 7-24)	
		[Header/Footer] (p. 7-31)	
[Document Details]	[Preview] (p. 7-70)		

Filing Settings (for public/personal/group User Boxes)

The following shows the Use/File - Filing Settings menu tree for Public, Personal, or Group User Boxes. The following describes items available using the framed buttons.



First level	Second level	Third level	Fourth level
			[Delete] (p. 7-66)
			[Edit Name] (p. 7-66)
			[Move] (p. 7-66)
			[Copy] (p. 7-67)
			[Save to External Memory.] (p. 7-67)
	[Document De- tails]		[Preview] (p. 7-70)

Application (for Public/Personal/Group User Boxes)

The following shows the File/Use - Application menu tree for Public, Personal, or Group User Boxes. The following describes items available using the framed buttons.



First level	Second level	Third level	Fourth level
[Edit Document]	[Delete Page] (p. 7-72)		
	[Rotate Page] (p. 7-73)		
	[Move Page] (p. 7-75)	[Preview/Specify by Input] (p. 7-77)	
	[Preview /Set Range] (p. 7-77)		
[Register Overlay] (p. 7-79)	[Overlay Image]		
	[Edit]	[New] (p. 7-80)	
		[Overwrite] (p. 7-81)	
	[Detail Settings] (p. 7-82)	[Density]	
		[Color]	
[Document Details]	[Preview]		

System User Box

The following shows the Use/File menu tree for System User Boxes.

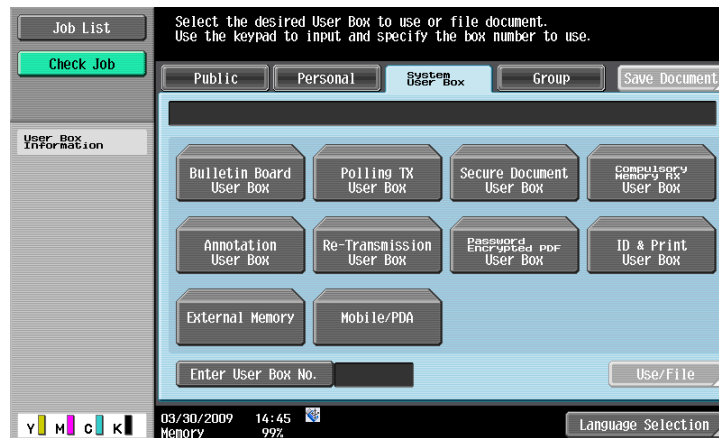

First level	Second level	Third level	Fourth level
			[Bulletin Board User Box] (p. 7-83)
			[Polling TX User Box] (p. 7-84)
			[Secure Document User Box]
	[Print]	[Copies] (p. 7-86)	
		[Print] (p. 7-86)	[1-Sided] [2-Sided]
		[Color] (p. 7-10)	[Full Color] [Black] [Use Existing Color Setting]
		[Finishing] (p. 7-10)	[Sort] [Group] [Offset] [Staple] [Punch] [Fold/Bind] (p. 7-12)
		[Combine] (p. 7-14)	[Combine Pages] [Combine Direction]
		[Zoom] (p. 7-15)	[Existing Setting] [Manual] [Full Size] [Minimal] [Fixed Zoom] [User Preset Zoom]
		[Page Margin] (p. 7-17)	[Margin Position] [Adjust Value] [Image Shift]
		[Sheet/Cover/Chapter Insert] (p. 7-18)	[Cover Sheet] [Insert Sheet] [Chapters]

First level	Second level	Third level	Fourth level
[Secure Document User Box]	[Print]	[Stamp/Composition] (p. 7-22)	[Date/Time]
			[Page Number]
			[Stamp]
			[Copy Security]
			[Stamp Repeat]
			[Header/Footer]
			[Registered Overlay]
	[Filing Settings] (p. 7-87)	[Delete]	
		[Edit Name]	
	[Document Details]	[Preview] (p. 7-70)	
[Compulsory Memory RX User Box]	[Print] (p. 7-88)		
	[Filing Settings] (p. 7-88)	[Delete]	
		[Edit Name]	
	[Document Details]	[Preview] (p. 7-70)	
[Annotation User Box]	[Print-Print]	[Copies] (p. 7-9)	
		[Print] (p. 7-9)	[1-Sided]
			[2-Sided]
		[Color] (p. 7-10)	[Full Color]
			[Black]
			[Use Existing Color Setting]
		[Finishing] (p. 7-10)	[Sort]
			[Group]
			[Offset]
			[Staple]
			[Punch]
			[Fold/Bind] (p. 7-12)
		[Combine] (p. 7-14)	[Combine Pages]
			[Combine Direction]
		[Zoom] (p. 7-15)	[Existing Setting]
			[Manual]
[Full Size]			
[Minimal]			
[Fixed Zoom]			
[User Preset Zoom]			
[Page Margin] (p. 7-17)	[Margin Position]		
	[Adjust Value]		
	[Image Shift]		

First level	Second level	Third level	Fourth level
[Annotation User Box]	[Print-Print]	[Sheet/Cover/Chapter Insert]	[Cover Sheet] (p. 7-19)
			[Insert Sheet] (p. 7-20)
			[Chapters] (p. 7-21)
		[Stamp/Composition] (p. 7-22)	[Date/Time] (p. 7-22)
			[Page Number] (p. 7-23)
			[Stamp] (p. 7-24)
			[Copy Security] (p. 7-25)
			[Stamp Repeat] (p. 7-30)
			[Registered Overlay] (p. 7-33)
			[Send-Send]
	[Direct Input]	[E-Mail] (p. 7-42)	
		[PC (SMB)] (p. 7-44)	
		[FTP] (p. 7-45)	
		[WebDAV] (p. 7-46)	
		[Job History] (p. 7-47)	
[Address Search] (p. 7-47)	[Search] (p. 7-48)		
	[Advanced Search] (p. 7-48)		
[Document Settings]	[Resolution] (p. 7-49)		
	[File Type] (p. 7-50)		
	[Color] (p. 7-54)		
[Communication Settings]	[E-mail Settings] (p. 7-57)		
	[URL Notification Setting] (p. 7-59)		
	[E-Mail Encryption] (p. 7-62)		
	[Digital Signature] (p. 7-62)		
[Application]	[Stamp/Composition] (p. 7-22)		
	[Send & Print] (p. 7-64)		
	[Stamp Element] (p. 7-92)		
[Filing Settings] (p. 7-94)	[Delete]		
	[Edit Name]		
[Application]	[Register Overlay] (p. 7-79)		
[Document Details]	[Preview] (p. 7-70)		

First level	Second level	Third level	Fourth level
[Re-Transmission User Box]	[Print]	[Proof Print] (p. 7-95)	
	[Send]	[Fax] (p. 7-95)	
	[Filing Settings]	[Delete] (p. 7-96)	
	[Document Details]	[Preview]	
[Password Encrypted PDF User Box]	[Print/Save]	[Print/Save] (p. 7-97)	
	[Filing Settings]	[Delete] (p. 7-97)	
	[Document Details]		
[ID & Print User Box]	[Print]	[Print] (p. 7-99)	
	[Filing Settings]	[Delete] (p. 7-99)	
	[Document Details]	[Preview] (p. 7-70)	
[External Memory]	[Print]	[Copies] (p. 7-102)	
		[Color] (p. 7-102)	[Full Color]
			[Black]
		[Print] (p. 7-102)	[1-Sided]
			[2-Sided]
		[Binding Position] (p. 7-102)	[Top]
			[Left]
			[Right]
		[Finishing] (p. 7-10)	[Sort]
			[Group]
			[Offset]
			[Staple]
			[Punch]
			[Fold/Bind]
		[Paper] (p. 7-103)	
[Stamp/Composition]	[Date/Time] (p. 7-22)		
	[Page Number] (p. 7-23)		
	[Stamp] (p. 7-24)		
	[Copy Security] (p. 7-25)		
	[Stamp Repeat] (p. 7-30)		
	[Document Details]		
[Mobile/PDA]	[Print List]	[Check Print Settings] (p. 7-106)	
		[Save in User Box] (p. 7-107)	

5

Accessing the User Box mode

5 Accessing the User Box mode

5.1 Accessing the User Box mode

Before starting this procedure, turn this machine on. When this machine is ready to copy data, the basic settings screen appears. To access the User Box mode, press the **User Box** key in the control panel.

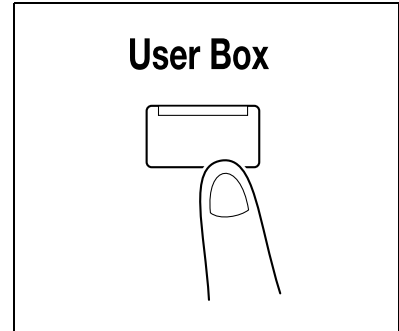

The User Box mode window appears. Lightly press the desired button in the window to display menus or functions. Then select the target one.

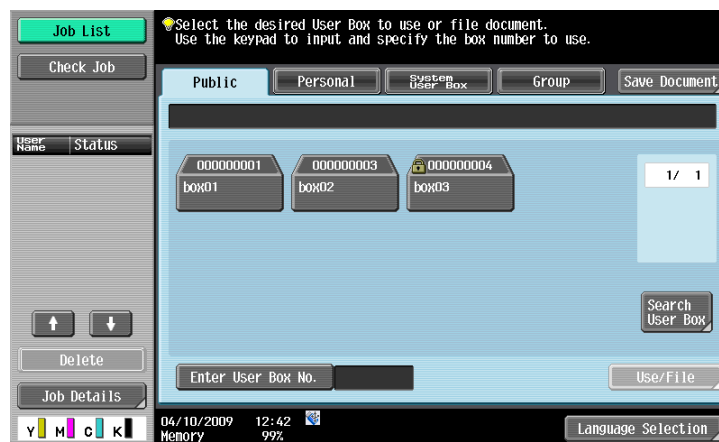

5.2 User Box Operation Menu

Accessing the User Box mode enables you to select the operation menus below.

5.2.1 Save Document

Scan the original loaded on this machine and save it in a User Box. You can specify the name or image quality of an original when saving it.



Reference

For details on the Save Document function, refer to page 6-4.

For details on the Save Document menu structure, refer to page 4-23.

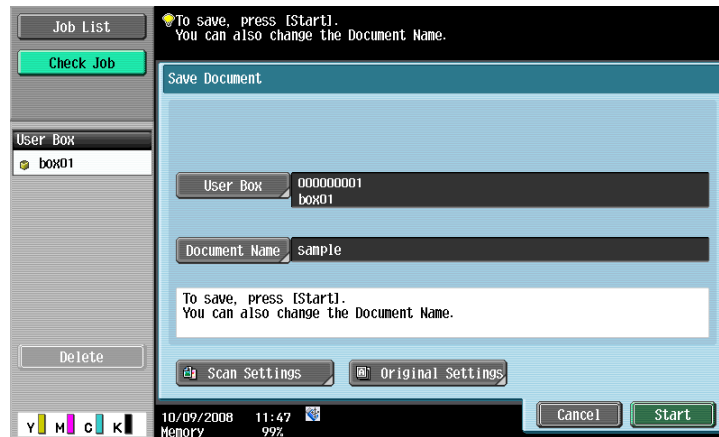

5.2.2 Use/File

Print or send a document saved in a User Box. When printing a document, you can specify the number of sets or page margins. When sending a document, you can specify the file type. If necessary, you can rename or move a document saved in a User Box, or copy a document to another User Box.



Reference

For details on the Use/File function, refer to page 7-3.

For details on the Use/File menu structure, refer to page 4-26.

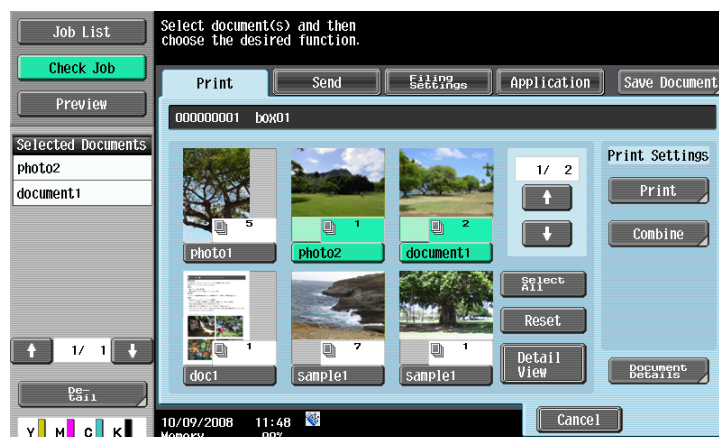



Save Document

6 Save Document

6.1 Save Document Overview

6.1.1 Functions

Save Document enables you to directly specify a destination User Box when saving a document in the User Box mode. Using Save Document, documents are saved in the same way as when scanned data is saved.

Public/Personal/Group User Boxes

You can save a document copied or scanned using this machine. You can also save a document that was print-instructed through a computer connected to a network. Some User Authentication or Account Track settings limit users who can use User Boxes such as the Personal or Group User Box.

Annotation User Box

If you want to print or send a document with the date and time or filing number image, save the document in the Annotation User Box. To use this box, select the [System User Box] tab, and then press [Annotation User Box].

External Memory

You can directly save a scanned document in the external memory connected to this machine. To use this function, check that the external memory is connected to the USB connector of this machine, select the [System User Box] tab, and then press [External Memory]. Otherwise, on the screen that is displayed when the external memory device has been connected to the USB connector, press [Save a document to External Memory].

Reference

- A function to save a document to the external memory or to save a document stored in the external memory to a User Box is set to OFF (cannot be saved) in the factory default. In addition, it is set to OFF (cannot be saved) by the user function settings when user authentication is enabled. To save a document in external memory, change the setting to enable you to save a document in Administrator Settings. For details, refer to page 8-23.



Reference

For information on the available external memory, refer to page 7-100.

6.1.2 Initial Window of Save Document

Public/Personal/Group User Boxes

Select the [Public], [Personal], or [Group] tab to display a list of User Boxes you can save a document in. Specify the desired User Box.



System User Box

Select the [System User Box] tab to display a list of User Boxes you can save a document in. Specify the desired User Box.

Reference

- If [Annotation User Box] is selected, further specify the desired User Box.

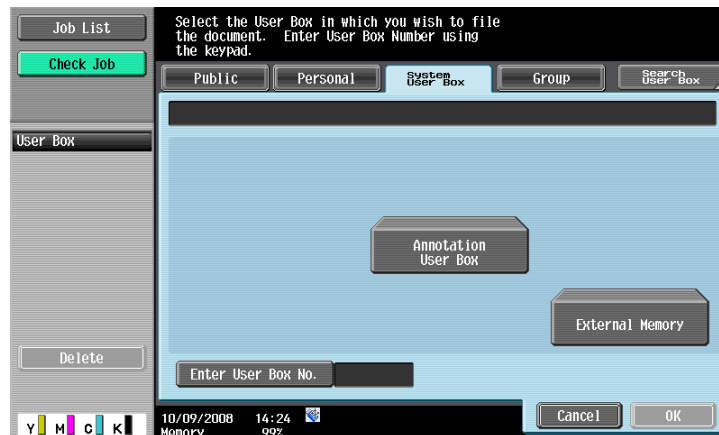

6.1.3 Save Document window

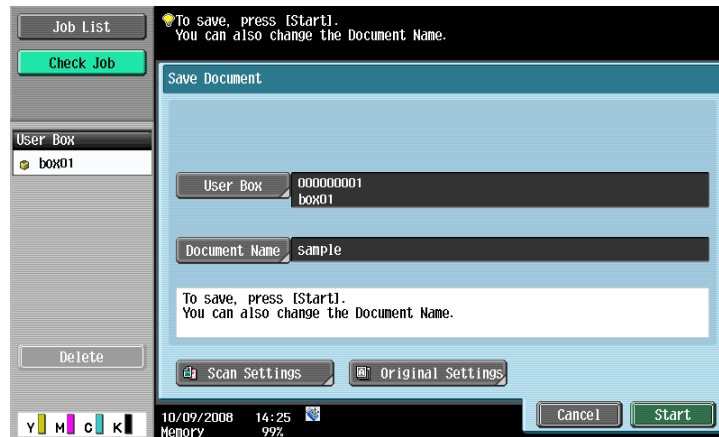

The available setting items in the Save Document screen are as follows.

Reference

- For the external memory, you cannot change the destination User Box.
- To save a document in external memory, change the setting to enable you to save a document in Administrator Settings. For details, refer to page 8-23.

Item	Description
[User Box]	For Public, Personal, Group and Annotation User Boxes, you can change the destination User Box for saving a document. To change the User Box, press [User Box] and select a User Box. <ul style="list-style-type: none"> • If there is no User Box with the specified number, a new Public User Box is automatically created.
[Document Name]	Press this button to display a keyboard to enter a document name. Enter the document name in the control panel.
[Scan Settings]	Configure detailed settings for scanning the document. For details, refer to page 6-6.
[Original Settings]	Configure the detailed settings for the original type and original direction. For details, refer to page 6-19.

6.2 Scan Settings

Press [Scan Settings] in the Save Document tab to configure the detailed scan settings.

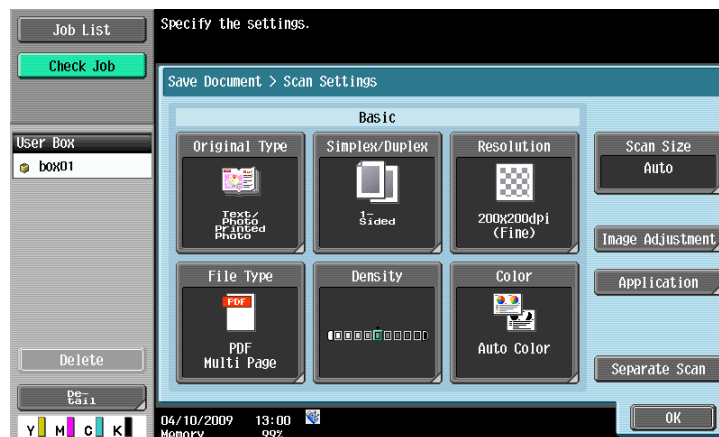

6.2.1 Basic - Original Type

Select the original type based on the original contents. The available original types are as follows.

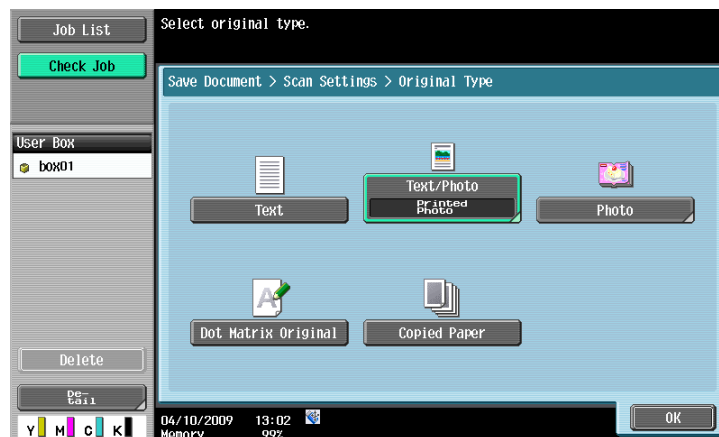

Item	Description
[Text]	Original that consists of only text.
[Text/Photo]	Original that consists of both text and photos (halftone).
[Photo]	Original that consists of only photos (halftone).
[Dot Matrix Original]	Original with faint-printing in whole.
[Copied Paper]	Original with even density that was printed using a copier or printer.

If you select [Text/Photo] or [Photo], you can also specify the photo type.

Item	Description
[Photo Paper]	Select this setting for a photo printed on printing paper.
[Printed Photo]	Select this setting for printed photos such as in books or magazines.

6.2.2 Basic - Simplex/Duplex

Select whether to scan one or both sides of the original.

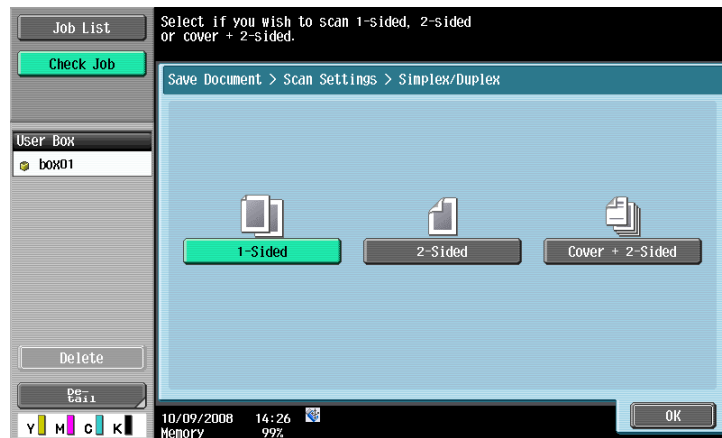

Item	Description
[1-Sided]	Scans one side of the original.
[2-Sided]	Scans both sides of the original.
[Cover + 2-Sided]	Scans the first page of the original as a cover in the single-sided mode, and also scans the remaining pages in the double-sided mode.

6.2.3 Basic - Resolution

Select the resolution for scanning.

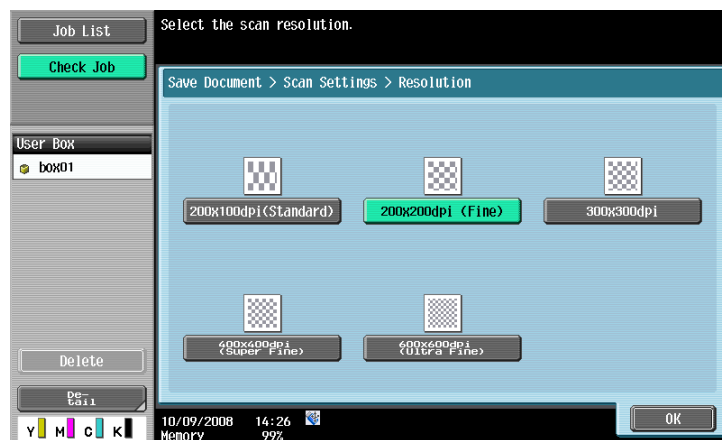

Reference

- The amount of data increases depending on the selected resolution, and you may not be able to save data in an external memory. If you cannot save data, reduce the resolution and retry saving it.

6.2.4 Basic - File Type

Select the file type to save scanned data.

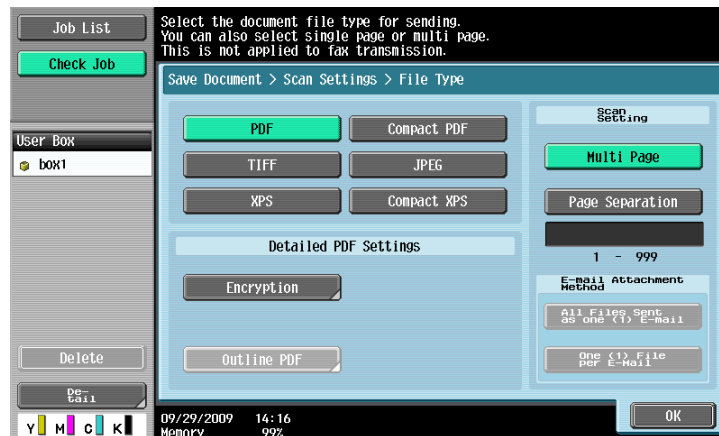

File Type

The available file types are as follows.

Item	Description
[PDF]	Saves data in PDF format.
[Compact PDF]	Further compressed PDF file. This format is useful when saving a scanned full color data.
[TIFF]	Saves data in TIFF format.
[JPEG]	Saves data in JPEG format.
[XPS]	Saves data in XPS format.
[Compact XPS]	Saves data in further compressed XPS file.



Reference

You can specify the compression format when saving a TIFF file in color. For details, refer to the [User's Guide Network Scan/Fax/Network Fax Operations].

You cannot specify some file formats depending on the Color settings. The following shows the combinations of the File Type and Color settings.

	Auto Color	Full Color	Gray scale	Black
PDF	<input type="radio"/>	<input type="radio"/>	<input type="radio"/>	<input type="radio"/>
Compact PDF	<input type="radio"/>	<input type="radio"/>	<input type="radio"/>	—
TIFF	<input type="radio"/>	<input type="radio"/>	<input type="radio"/>	<input type="radio"/>
JPEG	<input type="radio"/>	<input type="radio"/>	<input type="radio"/>	—
XPS	<input type="radio"/>	<input type="radio"/>	<input type="radio"/>	<input type="radio"/>
Compact XPS	<input type="radio"/>	<input type="radio"/>	<input type="radio"/>	—

Reference

- Even if you have selected the file type when saving a document in a User Box, you must specify the file type when downloading the data of the document.
- If you select [JPEG], [Page Separation] is automatically selected and set to [1 Every X Page(s)] in Scan Setting.

Encryption

If the [PDF] or [Compact PDF] is selected for the file format, the encryption level can be specified.

Reference

- You cannot check the contents of an encrypted document in the preview screen.

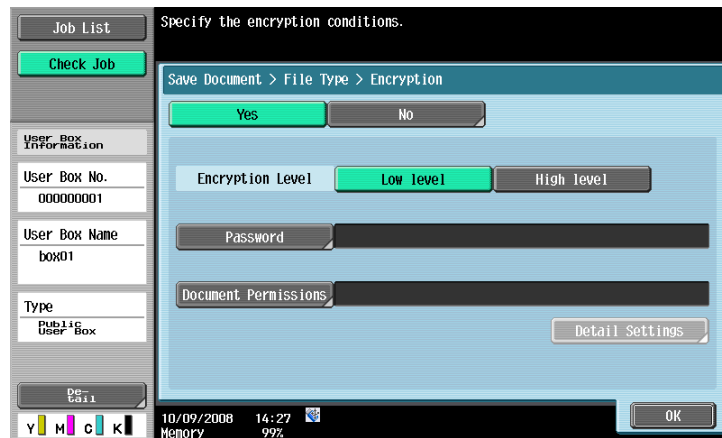

Item	Description
Encryption Level	Select the encryption level.
[Password]	Enter the password necessary to open encrypted data (up to 32 characters). For confirmation, enter the password twice.
[Document Permissions]	Enter the password necessary to change document permissions (up to 32 characters). For confirmation, enter the password twice.

Encryption - Detail Settings

Configure the detailed permission settings when the document permission is specified on the Encryption screen.

<When [Low level] is selected>



<When [High level] is selected>



Item	Description
[Printing Allowed]	Select whether to allow or restrict printing data. [Low Resolution] appears when the Encryption Level is set to [High level].
[Enable copying of text, images and other content]	Select whether to allow or restrict extracting text images.

Press [Forward →] to further configure Changes Allowed settings.

<When [Low level] is selected>



<When [High level] is selected>



Item	Description
[Changes Allowed]	Select the permission level about changes to the document, including signing, entering, or commenting data.

Outline PDF

Configure this item when [Compact PDF] is selected for the file type. This function performs outline processing for characters, ensuring a smooth display image. It is also available when editing data using an application such as Adobe Illustrator.



Reference

This function enables you to specify the accuracy of outline processing when creating outline PDF data. For details, refer to the [User's Guide Network Scan/Fax/Network Fax Operations].

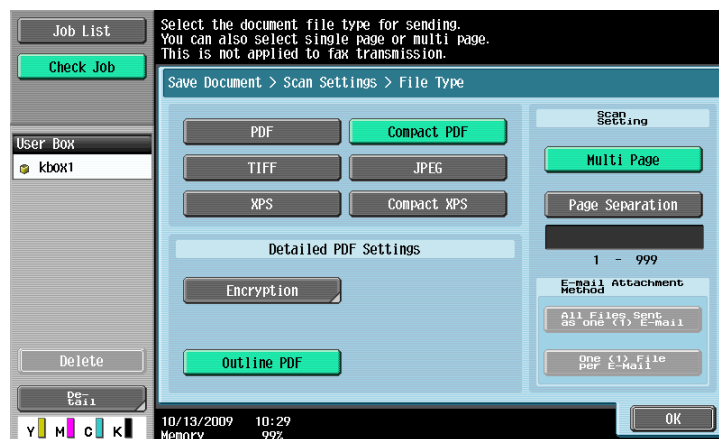

Scan Setting

Specify whether to save all pages of a document to one file, or to save each page to one file.

Item	Description
[Multi Page]	Creates all the scanned originals as one file. This item cannot be specified together with [JPEG].
[Page Separation]	Separates the scanned data to save every specified number of pages to one file. Use the keypad to enter the number of pages to be saved in one file.
[E-mail Attachment Method]	Specify the method to use to attach a file to an E-mail when Page Separation is selected. <ul style="list-style-type: none"> [All Files Sent as one (1) E-mail]: Attaches all files to one E-mail. [One (1) File per E-Mail]: Attaches one file to one E-mail.

Reference

- If you select [Page Separation] when saving a document in a User Box, the selection of Page Separation is stored, and then the document is saved as a [Multi Page] file.
- The selection of Page Separation is enabled when sending data to an E-Mail, PC (SMB), or FTP destination.

6.2.5 Basic - Density

Adjust the density for the scanned document.

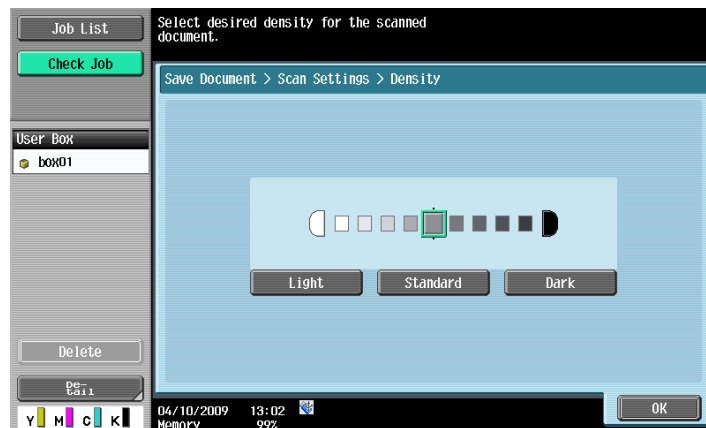

6.2.6 Basic - Color

Specify whether to scan original in color or black-and-white.

Item	Description
[Auto Color]	Automatically detects the color of the original and scans it to fit the original setting.
[Full Color]	Scans the original in full color.
[Gray Scale]	Select this setting for originals with high-level halftone such as black-and-white photos.
[Black]	Select this setting for originals with distinct black and white areas, such as line drawings.

Some color settings may not be available, depending on the selected File Type settings. The following shows the combinations of the File Type and Color settings.

	Auto Color	Full Color	Gray scale	Black
PDF	<input type="radio"/>	<input type="radio"/>	<input type="radio"/>	<input type="radio"/>
Compact PDF	<input type="radio"/>	<input type="radio"/>	<input type="radio"/>	-
TIFF	<input type="radio"/>	<input type="radio"/>	<input type="radio"/>	<input type="radio"/>
JPEG	<input type="radio"/>	<input type="radio"/>	<input type="radio"/>	-
XPS	<input type="radio"/>	<input type="radio"/>	<input type="radio"/>	<input type="radio"/>
Compact XPS	<input type="radio"/>	<input type="radio"/>	<input type="radio"/>	-

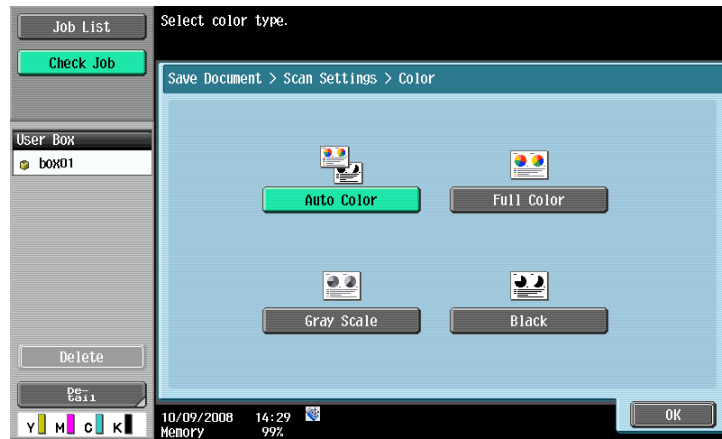

6.2.7 Scan Size

Select the paper size of the original to be scanned.

Standard size

Press [Auto] to automatically detect the size of the first page in the original when scanning. To scan the original with a predetermined paper size, select that size.

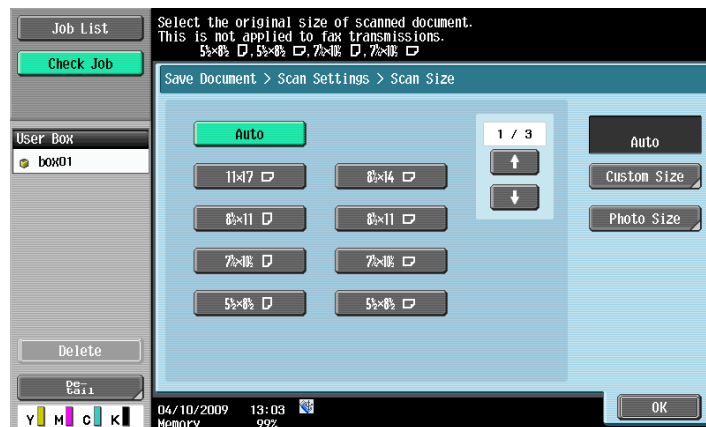

Custom Size

Enter the dimensions of a custom size other than the standard sizes.

Reference

- X-direction: Enter a value from 30.0 to 432.0 mm.
- Y-direction: Enter a value from 30.0 to 297.0 mm.

Photo Size

Select the 3 × 5 or 2-1/4 × 3-1/4 size for photographs.

6.2.8 Image Adjustment

Adjust the background density or sharpness for the scanned document.

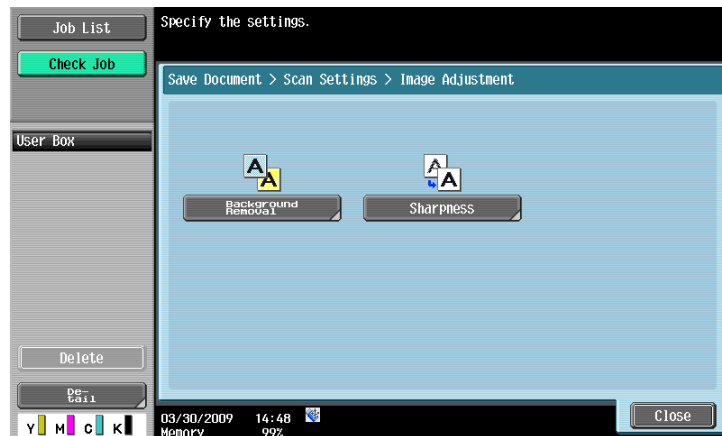

Background Removal

Adjust the background density of the scanned original. When scanning a colored-paper original, the background color may be scanned resulting in the entire image becoming dark. To avoid this, you can adjust the background density. Select the background removal method, and specify the level. To automatically adjust the density, press [Auto].

Reference

- To prevent the dark part in the back side from being scanned as shade, select [Bleed Removal].
- To scan an original with the colored background such as a map, select [Paper Discoloration Adj].

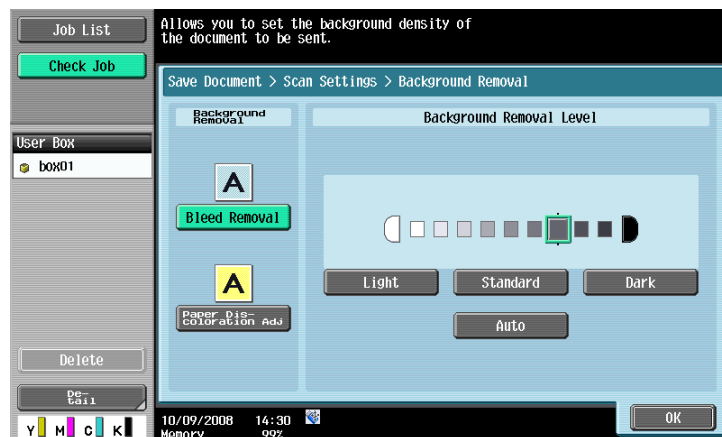

Sharpness

This settings allows you to sharpen character edges or other borders for the scanned document.

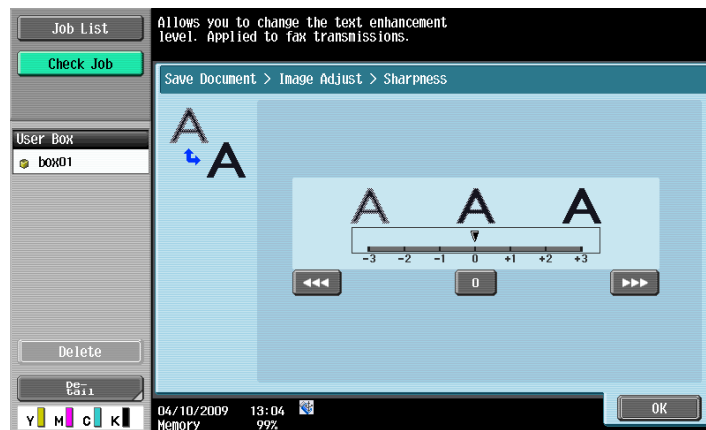

6.2.9 Application - Frame Erase

Configure the setting for erasing frames on a two-page spread.

Reference

- If you have specified the frame width to be erased in the Frame Erase setting of the Book Copy function, the same value is automatically configured for this [Frame Erase] function.
- To erase all frames with the same width, specify a numeric value between 1/16 and 2 inches (0.1 and 50.0 mm) under [Frame].
- To individually specify the top, left, right, and bottom widths, press the desired button and specify a numeric value for that side.
- To not erase frames, press [None].

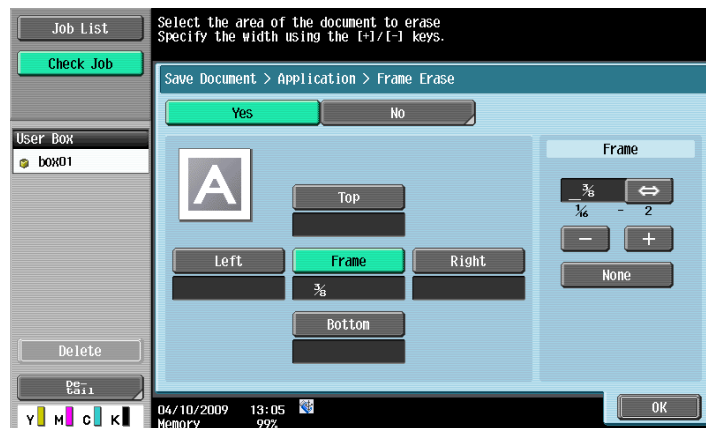

6.2.10 Application - Book Copy

Configure settings to scan a two-page spread. Settings include scanning method, binding positions and erasing unwanted areas. For paper size of the original, select the size of the spread.

Book copy method

Select the scanning method.

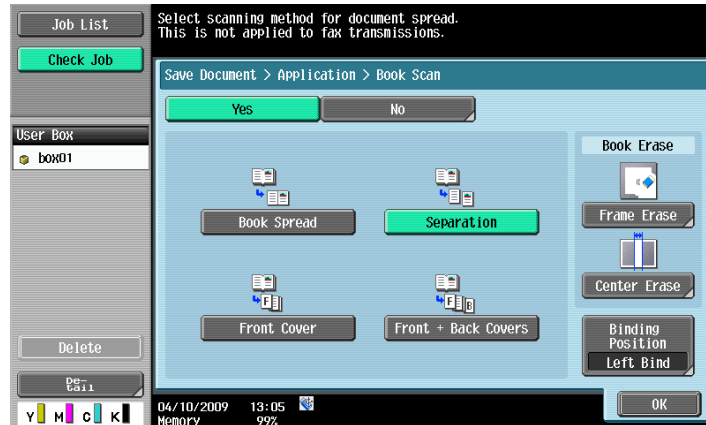

Item	Description
[Book Spread]	Scans a two-page spread as a single page.
[Separation]	Scans a two-page spread as two pages (left and right).
[Front Cover]	Scans the first page as a front cover.
[Front + Back Covers]	Scans the first page as a front cover, the second page as a back cover, and the third and subsequent pages as a body.

Book Erase - Frame Erase

Configure the setting for erasing frames on a two-page spread.

Reference

- If you have specified the frame width to be erased in the Frame Erase function, the same value is automatically configured for this [Frame Erase] setting of the Book Copy function.
- To erase all frames with the same width, specify a numeric value between 1/16 and 2 inches (0.1 and 50.0 mm) under [Frame].
- To individually specify the top, left, right, and bottom widths, press the desired button and specify a numeric value for that side.
- To not erase frames, press [None].

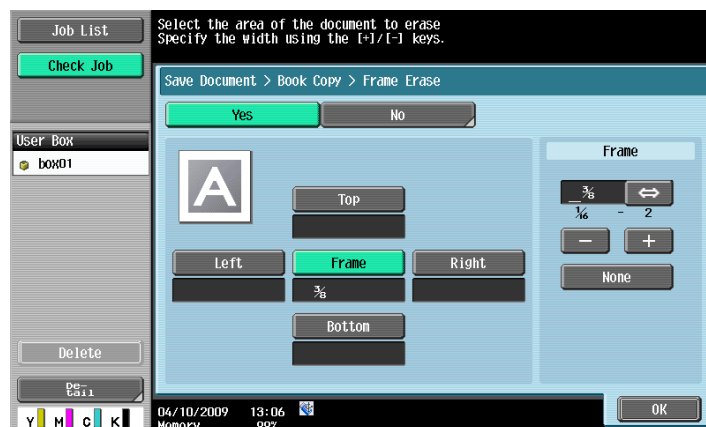

Book Erase - Center Erase

Configure settings to erase the shaded part around the binding position in the center of the original.

Reference

- Use the keypad or press [-] or [+] to enter a numeric value between 1/16 and 1-3/16 inches (0.1 and 30.0 mm).

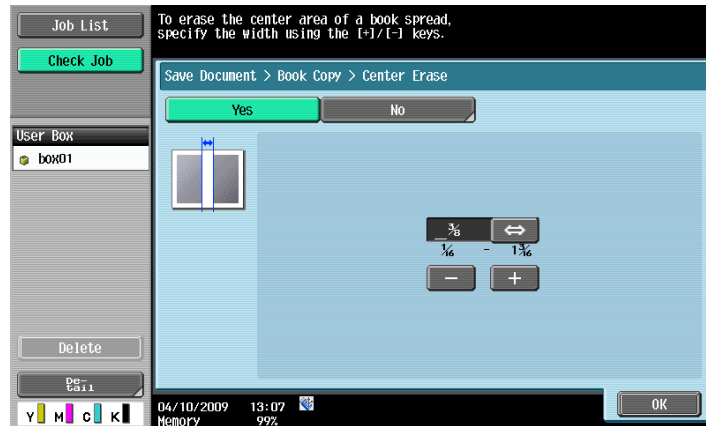

Binding Position

If you have selected Separation, Front Cover, or Front + Back Covers, press [Binding Position], and then select the binding position.

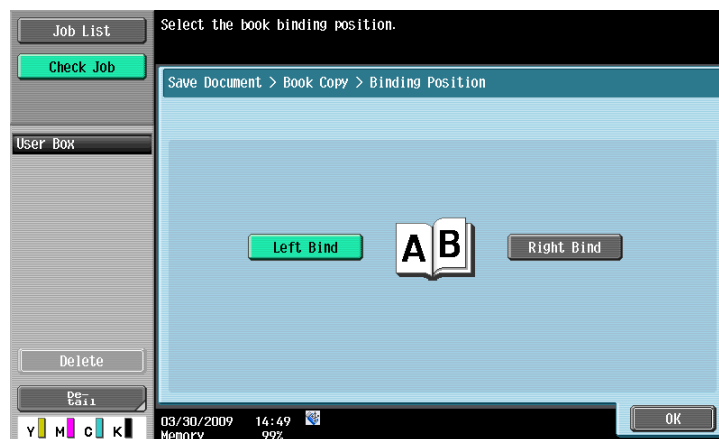

6.2.11 Separate Scan

The scan operation can be divided into several sessions by types of originals, for example, when all pages of originals cannot be loaded into the ADF, when the originals are placed on the original glass, or when single-sided originals and double-sided originals are mixed. Press [Separate Scan] to highlight the display.



6.3 Original Settings

Specify the type of original that is loaded, for example, if it contains mixed page sizes or Z-folded originals. Under Original Settings, you can select two or more items at the same time.

6.3.1 Special Original

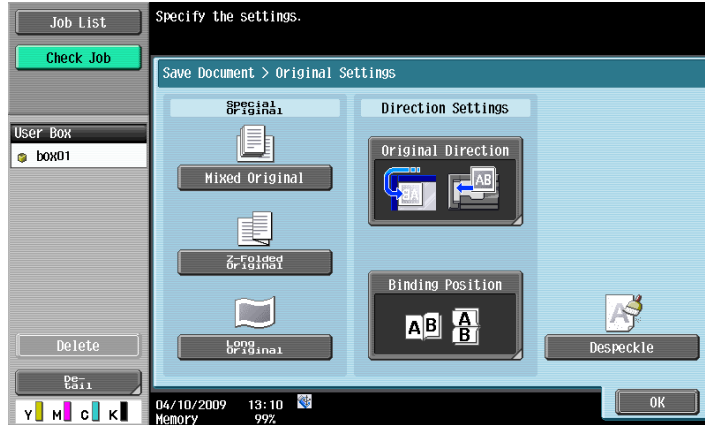

The available setting items are as follows.

Item	Contents
[Mixed Original]	Select this setting when loading originals with different sizes together into the ADF. The scanning speed will be lowered because the size of each page is detected before it is scanned.
[Z-Folded Original]	Select this setting to detect the size of a Z-folded original by the length fed through the ADF.
[Long Original]	Select this setting for originals that are longer than the standard size.

6.3.2 Direction Settings - Original Direction

Select the orientation of the original. After the document is scanned, the data is processed so that it is correctly oriented.

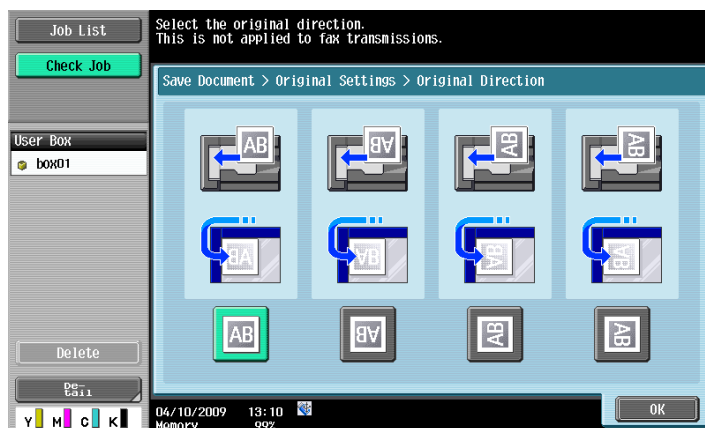

6.3.3 Direction Settings - Binding Position

Select the binding position of the original when it has punched holes or is stapled. When a double-sized original is scanned, the binding position is corrected on the back side.

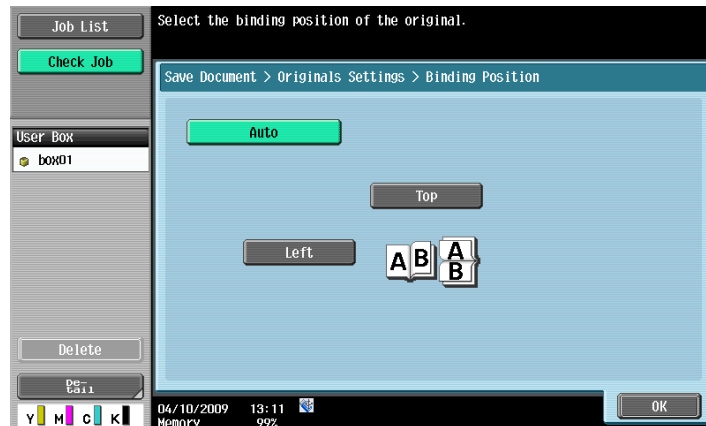

Item	Description
[Auto]	Sets the binding position to the long side if the size is 11-11/16 inches (297 mm) or smaller, or the short side otherwise.
[Top]	Select this setting if the original is loaded with the binding position at the top.
[Left]	Select this setting if the original is loaded with the binding position at the top.

6.3.4 Despeckle

Reduces the influence of a dirt of the slit glass upon the scanned image when loading an original in the ADF.

Reference

- Specifying Despeckle will drop the scanning speed.
- If the slit glass is too dirty, clean it. For details, refer to the [User's Guide Copy Operations].

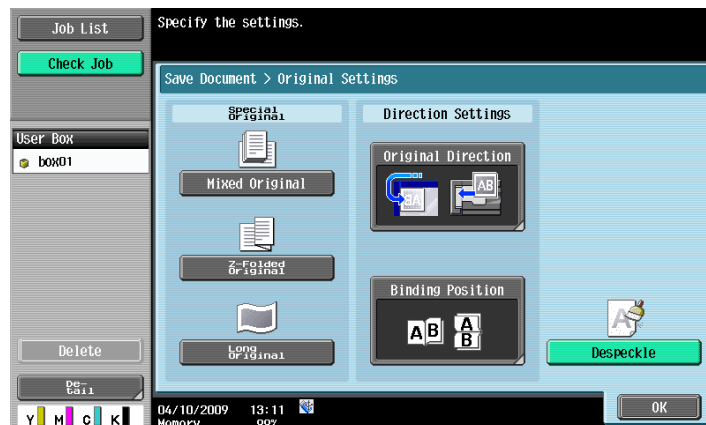

7 Use/File

7 Use/File

7.1 Overview of the Use/File operations

7.1.1 Functions of Use/File

Printing a document

You can print a document that was saved in a User Box in the Copy, Fax/Scan, print instruction, or Fax reception mode. You can add finishing settings such as the number of copies or 2-sided print settings when printing the document. In addition, you can specify Combine to print two or more documents at the same time.

Sending

You can distribute a document that was saved in a User Box in the Copy, Fax/Scan, print instruction, or Receive mode, for example, by E-mail or fax. You can add finishing or transmission settings when distributing the document. You can also specify Bind TX to select two or more documents and distribute them at the same time.

Filing

You can perform various document filing operations such as moving or copying documents between User Boxes. You can also save a document stored in a User Box in the external memory.

Application settings

You can move or rotate pages in saved documents, or register overlay images.

7.1.2 Detail of the Use Document screen

Select the User Box where you want to print and distribute documents. The following screen is displayed. This section describes the setting items, pointing to the Public User Box as an example.

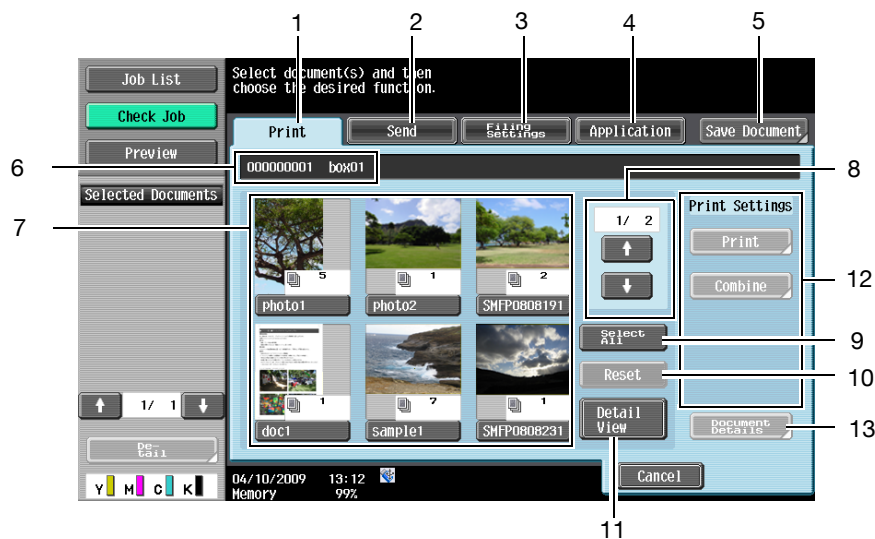

No.	Name	Description
1	[Print]	Configure settings to print the selected documents. (p. 7-6)
2	[Send]	Configure the destination and other settings to send the selected documents. (p. 7-35)
3	[Filing Settings]	Rename, move, or copy the selected documents. (p. 7-65)
4	[Application]	Edit the selected document on a page-basis or register overlay images. (p. 7-71)
5	[Save Document]	Select this tab to display the Save Document screen. The Use/File settings you have configured are canceled.
6	–	Displays the number and name of the specified User Box.
7	–	Displays a list of the documents saved in the User Box.
8	[↑][↓]	If the specified User Box contains seven or more documents, use [↑] or [↓] to scroll up or down the list.
9	[Select All]	Press this button to select all documents in the specified User Box.
10	[Reset]	Press this button to reset all documents in the User Box.
11	[Detail View]/[Thumbnail View]	Press this button to switch the display format of saved documents. [Thumbnail View]: A reduced image of the first page, number of pages, and document name of each document are displayed. [Detail View]: The time stored, user name, and document name of each document are displayed. Every time you press the [Time Stored] column header, the documents are sorted in ascending or descending order of the time stored alternately.
12	Print Settings/Transmission Settings/ Filing Settings/ Application Settings	Configurable items for the selected tab are displayed.
13	[Document Details]	Press this button to check the detailed information or preview image of the document.

7.1.3 If a password is specified for a User Box

If a password is specified for a User Box, the password entry screen appears. Enter the password, and press [OK].



7.2 Print

7.2.1 Overview of the Print tab

Description of the Print tab

Select the [Print] tab to display the following screen. The available setting items for [Print] are as follows.

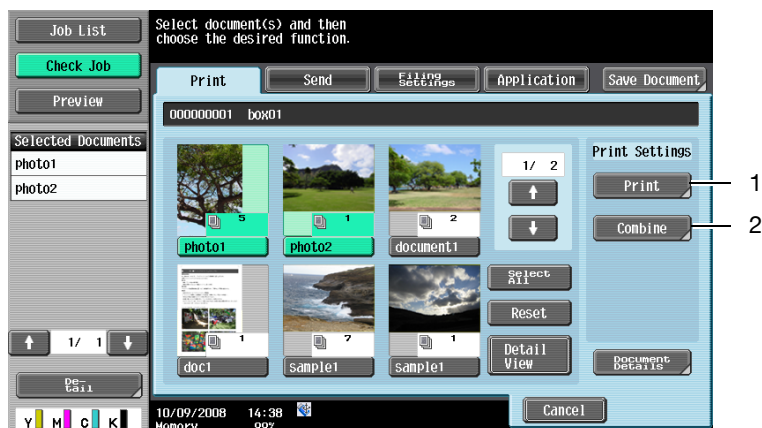

No.	Name	Description
1	[Print]	Configure settings to print the selected documents. If you have selected multiple documents, the document print setting function is not available. (p. 7-7)
2	[Combine]	Configure the printing order or other setting to print two or more document selected. (p. 7-8)



Reference

For details on other items, refer to page 7-4.

Print

Press [Print] to display the following screen. In the Print screen, the two categories of the configurable items are provided: [Basic] and [Application].

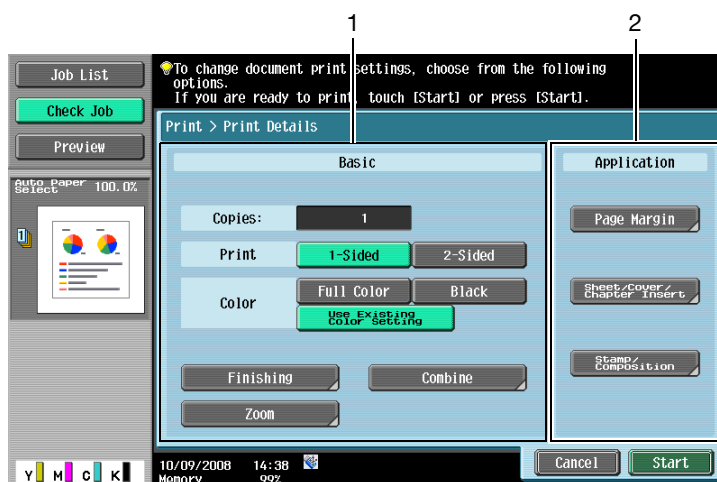

No.	Name	Description
1	[Basic]	Configure the basic settings such as the number of copies and 1-Sided or 2-Sided printing.

No.	Name	Description
2	[Application]	Configure the more complicated settings such as the page margin and stamp.

Combine

Press [Combine], and then configure Combine settings to display the following screen. In the Combine screen, two categories of the configurable items are provided: [Basic] and [Application].

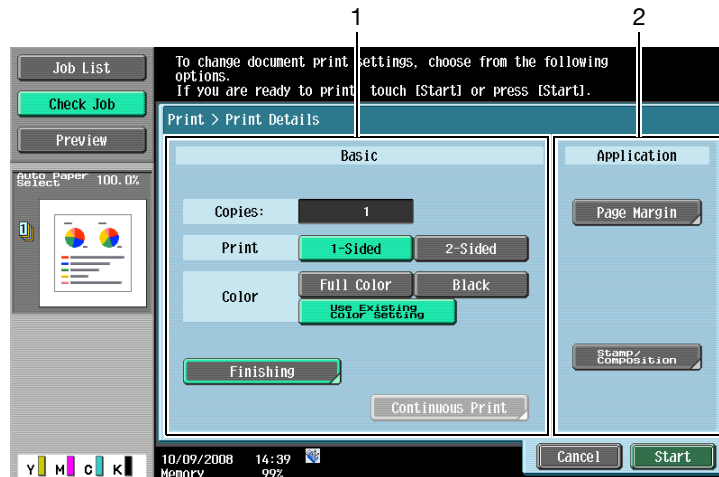

No.	Name	Description
1	[Basic]	Configure the basic settings such as the number of copies and 1-Sized or 2-Sized printing.
2	[Application]	Configure the more complicated settings such as the page margin and stamp.

7.2.2 Print

In the Print - Print Details screen, configure or change the following functions.

Item	Description
[Copies]	Specify the number of copies.
[Print]	Select either 1-Sided Print or 2-Sided Print.
[Color]	Configure color settings to print documents.
[Finishing]	Configure settings such as for sorting or grouping, stapling, punching, or folding or center stapling.
[Combine]	Configure settings to print multiple (2, 4, or 8) pages on one page when printing a multi-page document. Specify the number of sheets per page and the combination order.
[Zoom]	Configure settings to enlarge or reduce an image when printing documents. Select the magnification.
[Page Margin]	The page margin is set to the left, right, or top of paper. You can shift the image part according to the page margin.
[Sheet/Cover/Chapter Insert]	Configure settings to insert a cover sheet, insert sheets between selected pages, or insert sheets for separating chapters.
[Stamp/Composition]	Configure settings to print the determined items such as date and time or stamp.

Reference

- Fold/Bind can be configured when the optional **Finisher** is installed.
- The punch settings can be configured when the **Punch Kit** is installed on the optional **Finisher**.

7.2.3 Combine

Document Order

After selecting documents, press [Combine] to display the document order selection screen. Documents will be printed in the order they are displayed in this screen. When this screen appears, the documents are displayed in the order they were selected.

Reference

- To change the order, select a reorder source document, then a reorder destination document.

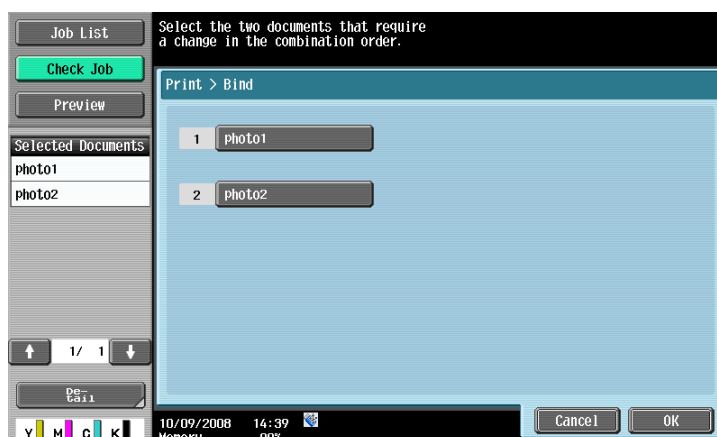

If a document has a watermark at the head, the same watermark is also printed for the second and subsequent documents.

If a document does not have a watermark at the head, no watermark is printed even when it is specified for some of the second and subsequent documents.

Configurable items to combine and print documents

In the Combine - Print Details screen, configure or change the settings for the following functions.

Item	Description
[Copies]	Specify the number of copies.
[Print]	Select either 1-Sided Print or 2-Sided Print.
[Color]	Configure color settings to print documents.
[Finishing]	Configure settings such as for offsetting, stapling, punching, or folding or center stapling.
[Continuous Print]	Configure this item when [2-Sided] is selected in [Print]. Specify whether, after printing an odd-page document, to print the first page of the next document on the back side of the last page of the first document.
[Page Margin]	The page margin is set to the left, right, or top of paper. You can shift the image part according to the page margin.
[Stamp/Composition]	Configure settings to print the determined items such as date and time or stamp.

Reference

- Fold/Bind can be configured when the optional **Finisher** is installed.
- The punch settings can be configured when the **Punch Kit** is installed on the optional **Finisher**.
- When combining and printing document, you cannot select the Sort, Group, or Tri-Fold function.

7.3 Print - Basic (Public, Personal, or Group User Box)

7.3.1 Copies

Use the keypad to enter the number of copies. The allowable range is 1 to 9999.

Reference

- To reset the setting to 1, press the [C] key on the control panel.

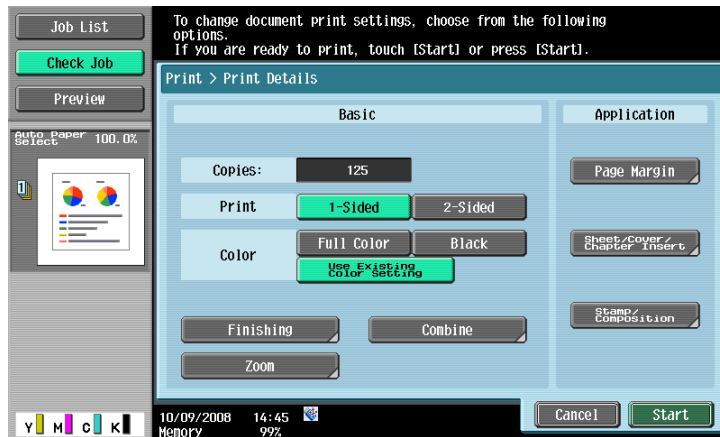

7.3.2 1-Sided/2-Sided

Select whether to print one side or both sides of sheets of paper.

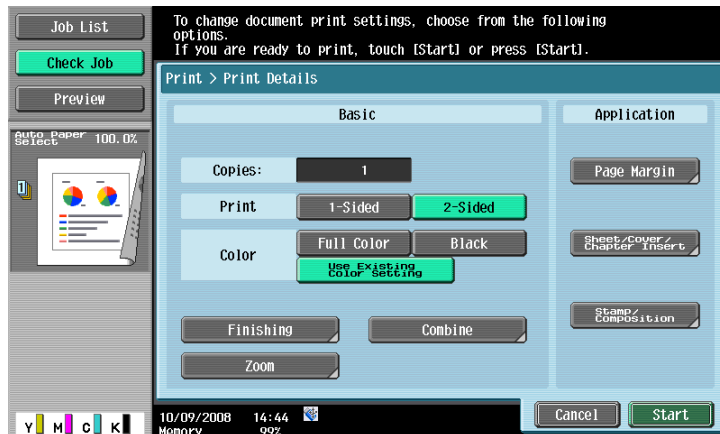

7.3.3 Color

Configure color settings to print documents.

Reference

- [Full Color]: Prints a document in full color.
- You can print documents saved in this machine in full color even if they are saved in black and white.
- [Black]: Prints a document in black and white.
- [Use Existing Color Setting]: Prints a document with the color settings used when it was saved.

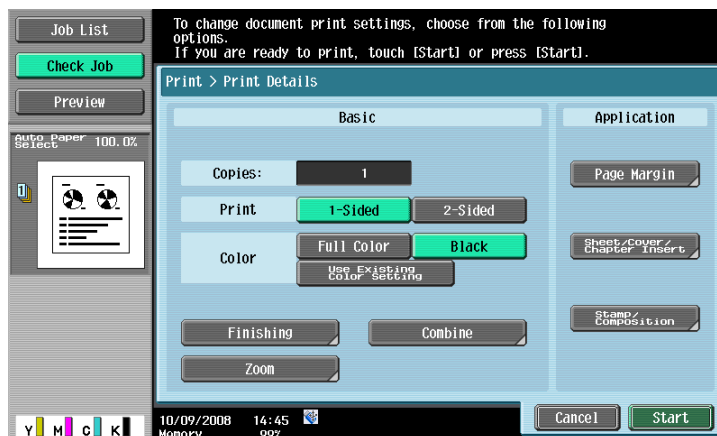

7.3.4 Finishing

Configure sorting, grouping, finishing and other settings.



Reference

When the finisher is installed, you can change the ejection method in Administrator Settings. For the Offset function, refer to the [User's Guide Copy Operations].

<When [Print] is selected>



<When [Combine] is selected>

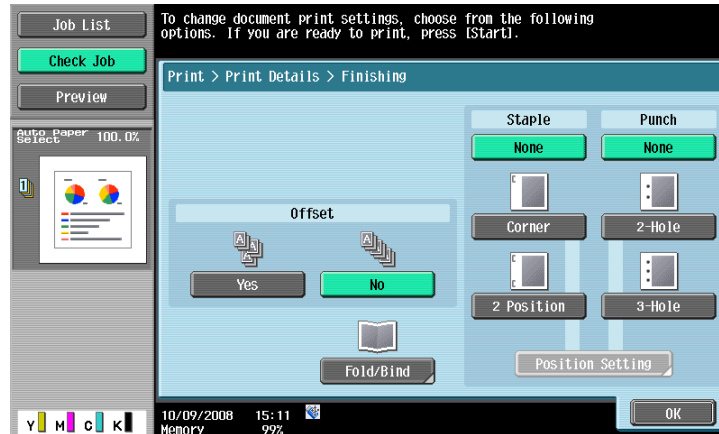

Sort/Group

Selecting Sort feeds copies by set. Selecting Group feeds copies by page.

Offset

Select Yes to sort sheets by set or page so that the user knows where the document is separated. When the finisher is installed, the printed sheets are fed while shifting them for each separation. When the finisher is not installed, the printed sheets are fed while alternately sorting them.

Staple

Printed sheets are stapled at a corner or two points.

Staple - Position Setting

If you select the type of stapling, specify the position. The following screen shows an example of [2 Position].

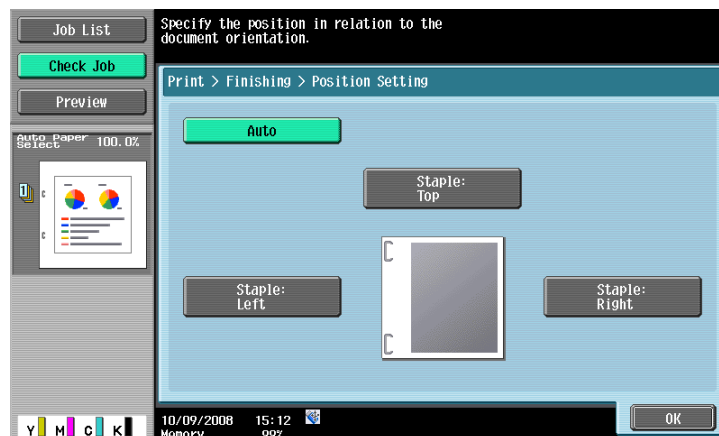

Punch

Printed sheets are punched for filing.

Punch - Position Setting

Specify hole positions.

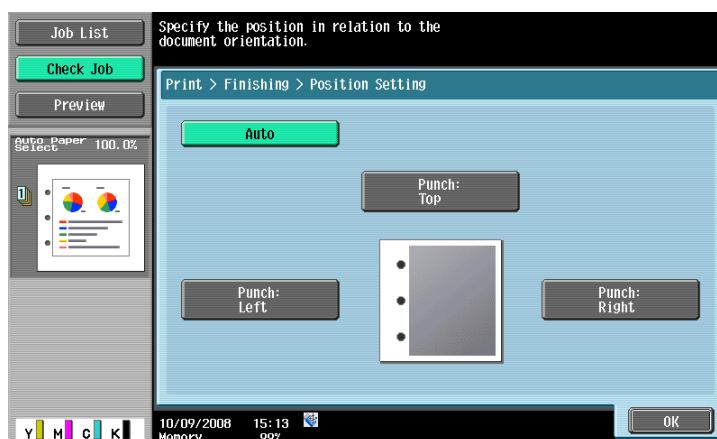

Fold/Bind

Configure the following settings when a finisher is installed.

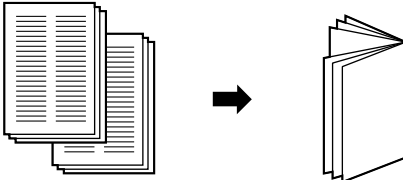
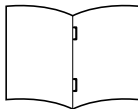
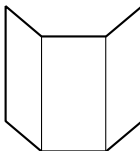
Item	Description
[Half-Fold]	<p>Folds printed sheets of paper before being fed.</p> 
[Center Staple & Fold]	<p>Staples printed sheets of paper at two center points and folds them in two before being fed.</p> 
Tri-Fold	<p>Select this setting when you use width-direction <input type="checkbox"/> paper. The long side of the printed sheets are folded in three.</p> <ul style="list-style-type: none"> This item is available when the optional finisher FS-526 is installed. 

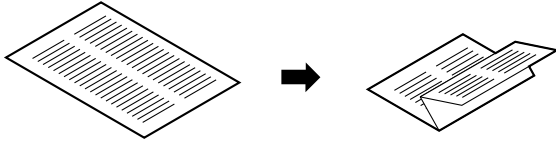
Item	Description
Z-Fold	<p>Select this setting when you use width-direction  paper. The long side of the printed sheets is Z-folded.</p> <ul style="list-style-type: none"> This item is available when the optional Z Folding unit ZU-606 is installed. <div style="text-align: center;">  </div>

Select the desired function.

When finisher FS-527 is installed:

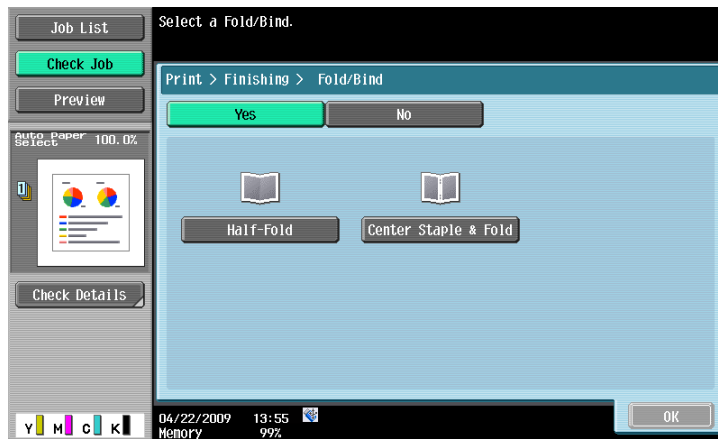

When finisher FS-526 and Z Folding unit ZU-606 are installed:

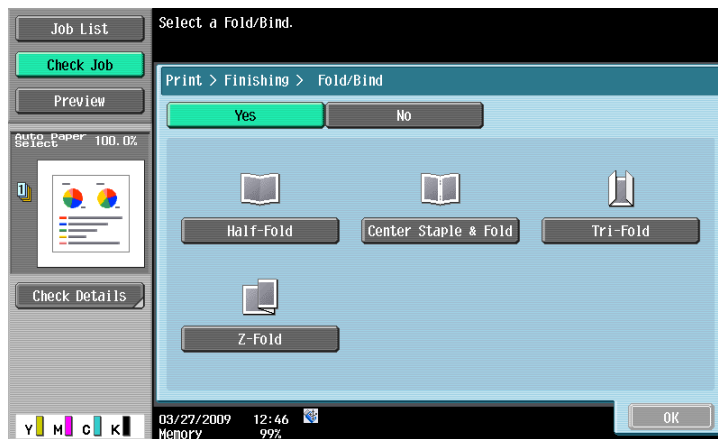

7.3.5 Combine

A multi-page original is combined and printed on one page.



Item	Description
[2in1]	Combines a 2-page original into one page.
[4in1]	Combines a 4-page original into one page. You can select the combining order of original pages.
[8in1]	Combines An 8-page original into one page. You can select the combining order of original pages.

7.3.6 Zoom

The images can be enlarged or reduced when they are printed. Specify the magnification.

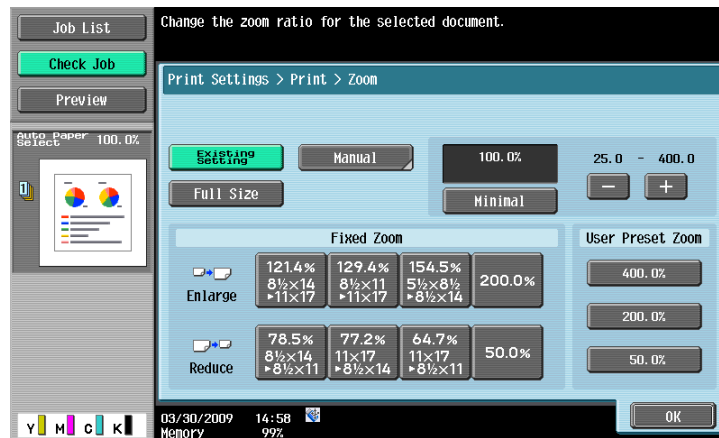

Item	Description
[Existing Setting]	Prints A document with the magnification that was specified when it was saved.
[Manual]	Specify the magnification between 25.0% and 400.0% on a 0.1% basis. Use the keypad to directly enter the magnification.
[Full Size]	Prints a document with the size specified when it was saved, without being enlarged or reduced.
[Minimal]	Reduces a document slightly to leave margin around the image.
[+][-]	Press this button to adjust the zoom ratio of the image on a 0.1% basis.
[Fixed Zoom]	Specify the fixed magnification that is preset in this machine. This setting is useful when enlarging or reducing documents to a standard size.
[User Preset Zoom]	In addition to fixed magnifications, preset frequently used magnifications in advance and use them later. <ul style="list-style-type: none"> You can preset up to three magnifications. <div style="text-align: center;">  Reference <i>For details on presetting magnifications, refer to the [User's Guide Copy Operations].</i> </div>

Reference

- Regardless of the Use Existing Color Setting or Original Type setting, you can print documents saved in A4 size in enlarged A3 size. To rotate and enlarge the image as shown in the example, you must previously set [Enlargement Rotation] to [Allow] in the Utility menu. For details on the enlargement rotation, refer to the [User's Guide Copy Operations].

7.3.7 Continuous Print

You can select this setting if you have selected 2-Sided printing when combining and printing documents. Multiple documents are printed continuously when they are combined and printed. When printing in 2-Sided mode, select whether, if printing a document ends on the front side of a sheet of paper, to start printing of the next document on the back side of the sheet or on the front side of a new sheet.

Reference

- [Yes]: The next document is printed continuously from the back side of the last page of the previous document.
- [No]: The next document is printed from the front side of a new sheet.

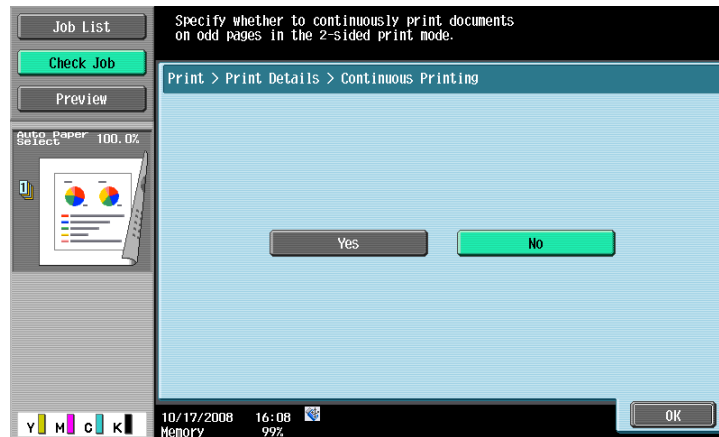

7.4 Print - Application (Public, Personal, or Group User Box)

7.4.1 Page Margin

The page margin is set to the left, right, or top of paper. It can assure a punching or stapling space.

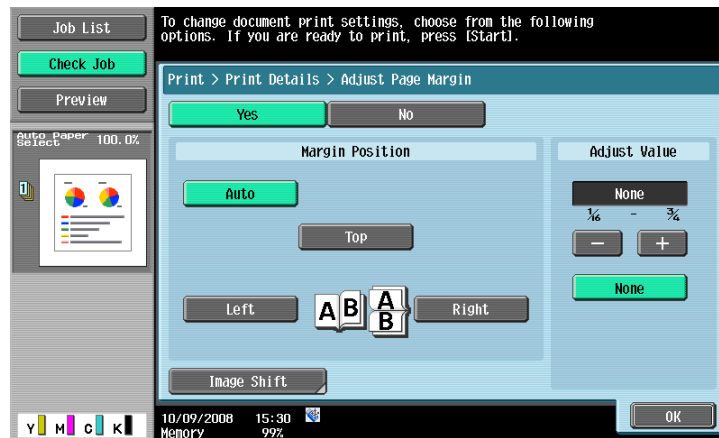

Page Margin

Item	Description
[Margin Position]	Select the margin position. [Auto]: A page margin position along the long side of the paper is selected if the original length is 11-11/16 inches (297 mm) or less. A page margin is created along the short side of the paper if the original length exceeds 11-11/16 inches (297 mm). [Top]: Select this setting to position a margin on the top. [Left]: Select this setting to position a margin on the left. [Right]: Select this setting to position a margin on the right.
[Adjust Value]	Specify the width of a page margin between 1/16 and 3/4 inches (0.1 and 20.0 mm). To set the margin width to 0 inch (0 mm), press [None].

Image Shift

When a page margin is created, the image can be shifted according the position of the margin. You can specify the shift length to move the image to the left, right, top, or bottom within 1/16 to 10 inches (0.1 to 250.0 mm) to fit the page margin position.

Reference

- Specify the page margin width on a 1/16 inch (0.1 mm) basis by pressing [-] or [+].
- To set the margin width to 0 inch (0 mm), press [No Shift].

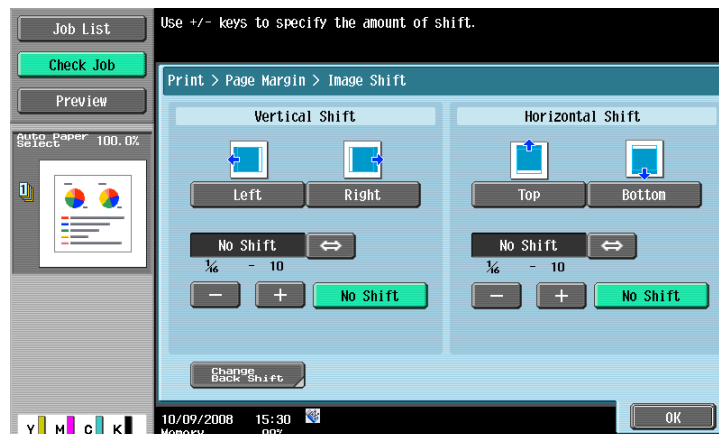
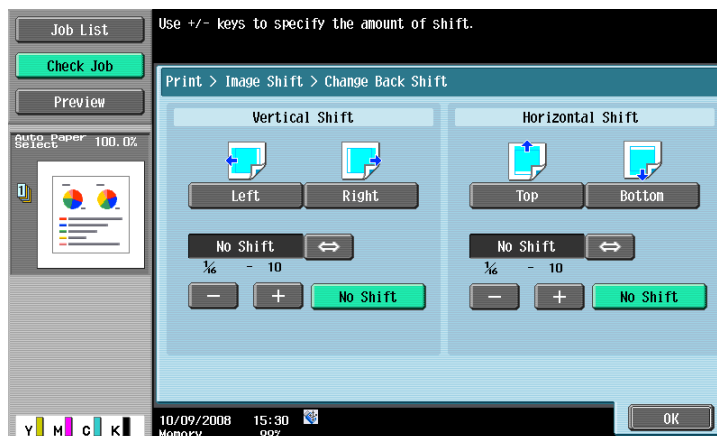

Image Shift - Change Back Shift

To create a page margin in 2-Sided printing mode, press [Change Back Shift] to specify the image shift length on the back side. You can specify the shift length to move the image to the left, right, top, or bottom within 1/16 to 10 inches (0.1 to 250.0 mm) to fit the page margin position.

Reference

- Specify the page margin width on a 1/16 inch (0.1 mm) basis by pressing [-] or [+].
- To set the margin width to 0 inch (0 mm), press [No Shift].



7.4.2 Sheet/Cover/Chapter Insert

You can configure the Cover Sheet, Insert Sheet, or Chapters function.

Item	Description
[Cover Sheet]	Prints documents with front and back covers.
[Insert Sheet]	Inserts colored sheets or other type of paper before the specified pages when documents are printed.
[Chapters]	Configure this setting when printing documents in 2-Sided printing mode. Documents are printed while pages are fed so that the specified pages, the first page of each chapter for example, necessarily turns to the front side.

7.4.3 Sheet/Cover/Chapter Insert - Cover Sheet

Documents are printed with front and back covers.

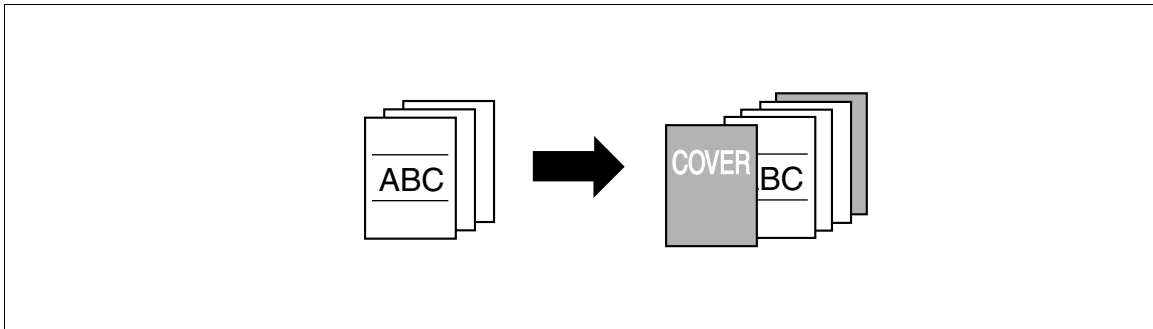

The available setting items are as follows.

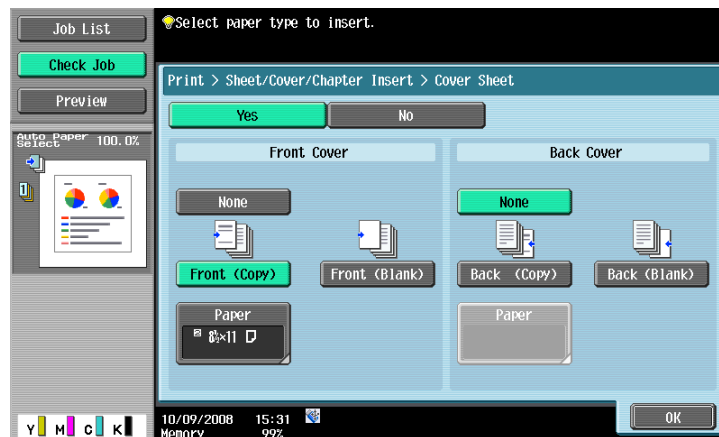

Item	Description
[Front Cover]/ [Back Cover]	Configure settings for front and back covers. For details, refer to the table below.
[Paper]	Select a paper tray in the following cases. <ul style="list-style-type: none"> • When [Front (Copy)] or [Front (Blank)] is selected for [Front Cover] • When [Back (Copy)] or [Back (Blank)] is selected for [Back Cover]

The following shows the front and back cover settings.

Item	Description	
Front Cover	None	A front cover is not attached to a document.
	Front (Copy)	The first page of a document is printed on the front cover sheet. The second page is printed on the back side of the front cover sheet when [2-Sided] printing is selected.
	Front (Blank)	A blank sheet is inserted before the first page of a document.
Back Cover	None	A back cover is not attached to a document.
	Back (Copy)	The last page of a document is printed on the back cover sheet. The last two pages are printed on the front and back sides of the back cover sheet when [2-Sided] printing is selected.
	Back (Blank)	A blank sheet is inserted after the last page of a document.

Reference

- Load the front and back cover sheets in the tray in advance.
- To add cover sheet setting when printing the document that you copied and saved in a User Box, either one of the following conditions must have been satisfied when you saved the document.
 - A paper tray was specified
 - Cover Sheets were configured

7.4.4 Sheet/Cover/Chapter Insert - Insert Sheet

Colored sheets or other type of paper are inserted before the specified pages when documents are printed. You can configure the setting to insert sheets into up to 30 positions in an original of up to 999 pages.

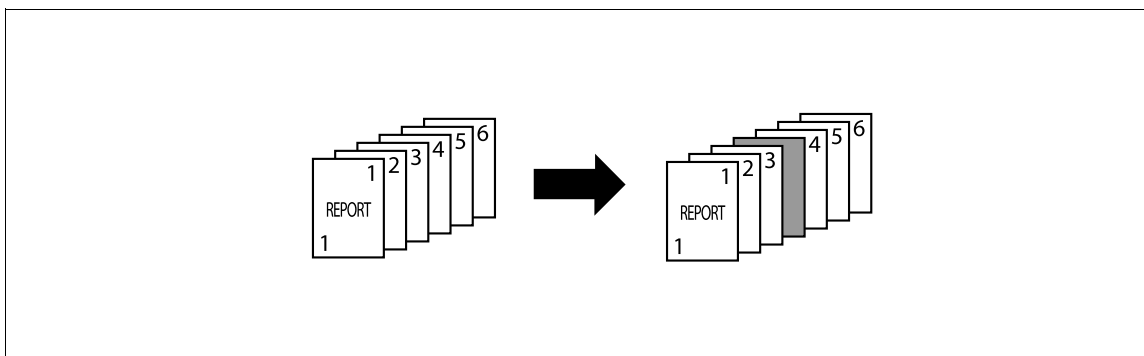

The available setting items are as follows.

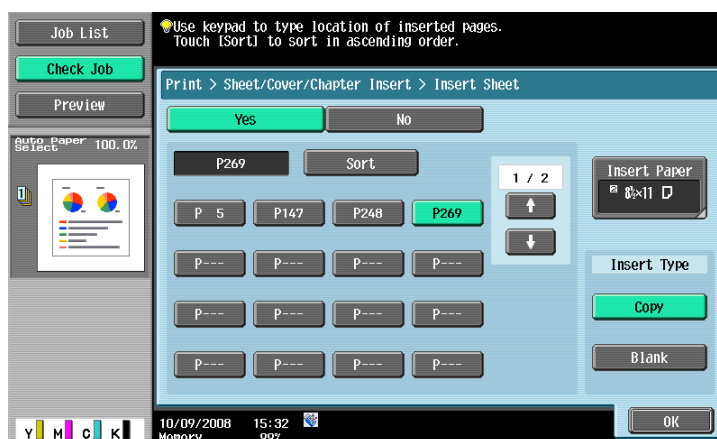

Item	Description
Page specification/[Sort]	Specify a page you want to insert a sheet into. Press a page button, and use the keypad to enter the desired page number. To sort the entered pages in ascending order, press [Sort].
[Insert Paper]	Select a tray to load the sheets to be inserted. Check that sheets are loaded with the same size and orientation as for the printing paper.
[Insert Type]	Specify whether to print a document on the inserted sheets (Copy) or leave them blank (Blank). For details, refer to the table below.

Select [Copy] or [Blank] in Insert Type. Configure the setting as follows depending on whether you select 1-Sided or 2-Sided printing. Example: When page "6" is specified

Item	Description
[Copy] (when 1-Sided is selected)	A sheet is inserted as the sixth sheet and the sixth page of the document is printed on that sheet.
[Copy] (when 2-Sided is selected)	The back side of the third sheet is left blank. A specified sheet is inserted as the fourth sheet and the sixth and seventh pages of the document are printed on that sheet.

Item	Description
[Blank] (when 1-Sided is selected)	A specified sheet is inserted after the sixth page.
[Blank] (when 2-Sided is selected)	A specified sheet is inserted as the fourth sheet. When you specify an odd pages, the back side of the inserted sheet is left blank.

7.4.5 Sheet/Cover/Chapter Insert - Chapters

You can configure this setting when printing documents in 2-Sided printing mode. Documents are printed while pages are fed so that the specified pages, the first page of each chapter for example, necessarily turns to the front side. You can configure the setting to insert sheets into up to 30 positions in an original of up to 999 pages.

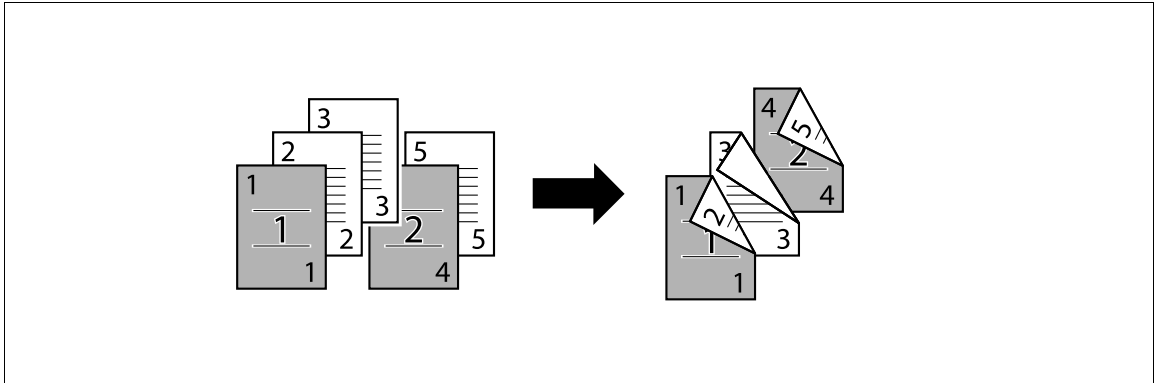

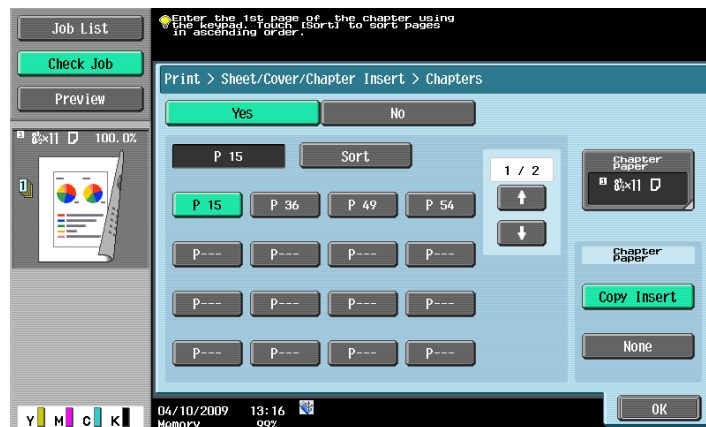

The available setting items are as follows.



Item	Description
Page specification/[Sort]	Specify front-sided pages. Press a page button, and use the keypad to enter the desired page number. To sort the entered pages in ascending order, press [Sort].
[Chapter Paper]	To copy document data on chapter sheets, select [Copy Insert] and select a chapter paper tray. Check that sheets are loaded with the same size and orientation as for the printing paper.

7.4.6 Stamp/Composition

In Stamp/Composition screen, you can configure the following functions.

Item	Description
[Date/Time]	The date and time of printing are printed on the pages.
[Page Number]	A page number is printed on all pages of a document.
[Stamp]	A preset character string such as "URGENT" is printed on pages.
[Copy Protect]	Hidden text is printed on all pages to prevent unauthorized copying.
[Copy Guard]	A stamp is printed on all pages as a copy guard.
[Password Copy]	A document is printed with an embedded password on all pages to prevent unauthorized copying.
[Stamp Repeat]	Text or an image is repeatedly printed on all pages.
[Header/Footer]	<p>A header or footer is printed on pages.</p> <ul style="list-style-type: none"> This item is not displayed when the header or footer is not registered. <p> Reference <i>For details on how to register a header or footer, refer to the [User's Guide Copy Operations] or [User's Guide Network Scan/Fax/Network Fax Operations].</i></p>
[Registered Overlay]	<p>A registered image is overlaid on printed pages.</p> <ul style="list-style-type: none"> This item is not displayed when no overlay image is registered. <p> Reference <i>For details on how to register an overlay image, refer to page 7-79.</i></p>

7.4.7 Stamp/Composition - Date/Time

The date and time of printing are printed on the pages.

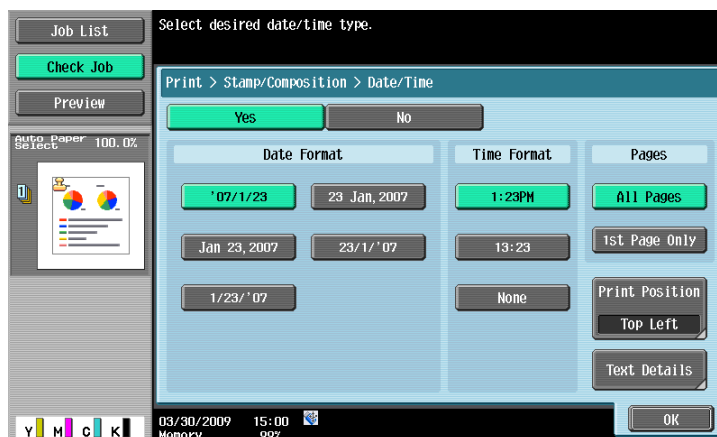

Item	Description
[Date Format]	Select the format for the date.
[Time Format]	Specify whether to add the time, and select the format to display the time.
[Pages]	Select whether to print the date and time on all pages or the first page only.
[Print Position]	Specify the print position. To fine-adjust the print position, press [Adjust Position]. Specify the shift length of the print position to the left, right, top or bottom using a value between 1/16 and 1-15/16 inches (0.1 and 50.0 mm).
[Text Details]	<p>Specify the details of text to be printed.</p> <ul style="list-style-type: none"> Text Color: Select the printing color from black, red, blue, green, yellow, cyan, or magenta. Text Size: Select the printing text size from 8 pt, 10 pt, 12 pt, or 14 pt. Text Type: Select the font type from Times Roman or Helvetica.

7.4.8 Stamp/Composition - Page Number

The page number is printed on all pages of the document.

Settings

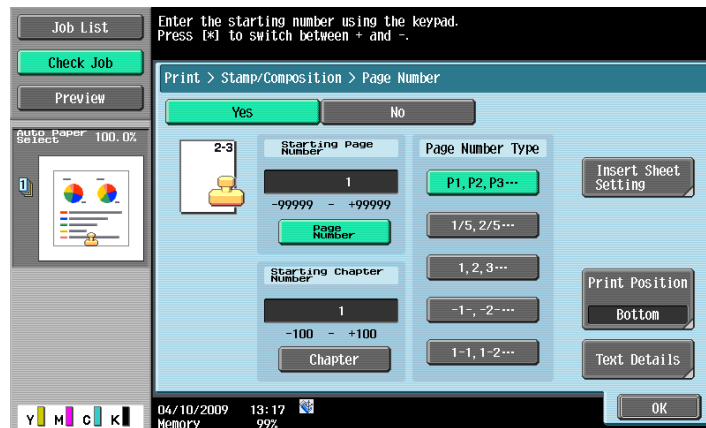

Item	Description
[Starting Page Number]	Specify the starting page number.
[Starting Chapter Number]	Specify the starting chapter number.
[Page Number Type]	Select the format to display a page number.
[Insert Sheet Setting]	Specify whether to print a page number on an inserted sheet. For the available settings, refer to page 7-24.
[Print Position]	Specify the print position. To fine-adjust the print position, press [Adjust Position]. Specify the shift length of the print position to the left, right, top or bottom using a value between 1/16 and 1-15/16 inches (0.1 and 50.0 mm).
[Text Details]	Specify the details of text to be printed. <ul style="list-style-type: none"> [Text Color]: Select the printing color from black, red, blue, green, yellow, cyan, or magenta. [Text Size]: Select the printing text size from 8 pt, 10 pt, 12 pt, or 14 pt. [Text Type]: Select the font type from Times Roman or Helvetica.

Insert Sheet Setting

Specify whether to print a page number on inserted sheets.



Item		Description
[Cover Sheet]	[Print on Front and Back Cover]	A page number is printed on the front and back covers.
	[Print on Back Cover only]	A page number is not printed on the front cover.
	[Do not print Page Number]	A page number is printed on neither the front cover nor the back cover.
[Insert Sheet (Copy)]	[Print Page #]	A page number is printed on inserted copy sheets.
	[Do Not Print #]	A page number is not printed on inserted copy sheets.
	[Skip the Page(s)]	Inserted copy sheets are not counted. Page numbers are not printed.
[Insert (Blank)]	[Do Not Print #]	Page numbers are not printed on inserted blank sheets.
	[Skip the Page(s)]	Inserted blank sheets are not counted. Page numbers are not printed.

7.4.9 Stamp/Composition - Stamp

A preset character string such as "URGENT" is printed on pages.

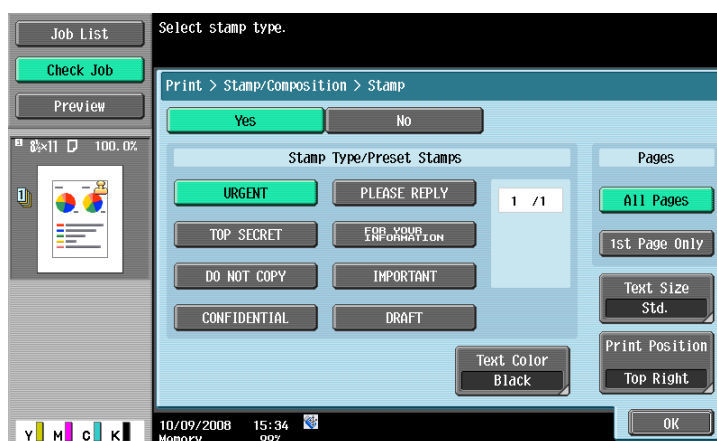

Item	Description
[Stamp Type/Preset Stamps]	Select a stamp type such as URGENT, PLEASE REPLY, or DO NOT COPY.
Pages	Select whether to print the date and time on all pages or the first page only.

Item	Description
[Text Size]	Select the printing text size from Minimal or Standard.
[Text Color]	Select the printing color from black, red, blue, green, yellow, cyan, or magenta.
[Print Position]	Specify the print position. To fine-adjust the print position, press [Adjust Position]. Specify the shift length of the print position to the left, right, top or bottom using a value between 1/16 and 1-15/16 inches (0.1 and 50.0 mm).

7.4.10 Stamp/Composition -Copy Security -Copy Protect

Hidden text is printed on all pages to prevent unauthorized copying. When a document printed with copy protection text is copied, the hidden text appears clearly repeated throughout the pages of the copies so that the reader knows that it is a copy.

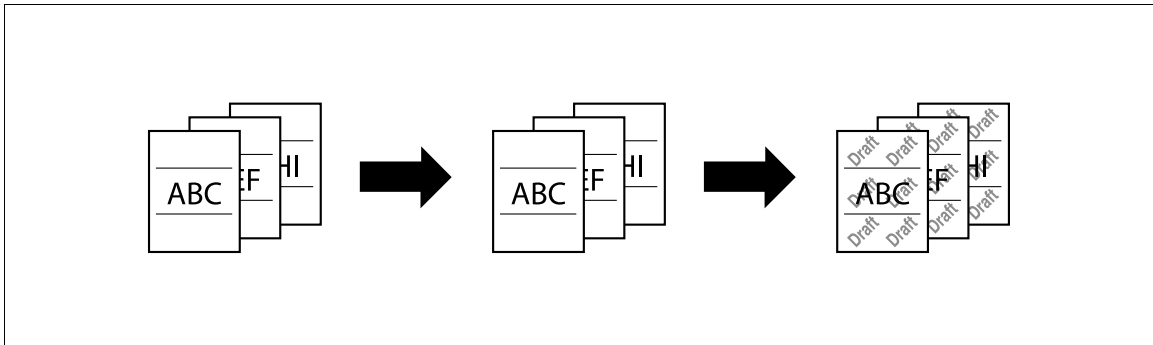

Configure the setting for the copy protect to be applied. You can apply up to eight strings or stamps. If you set the angle of strings or stamps to 45 degrees (or -45 degrees), however, the number of areas in which you can place strings or stamps is limited to 4.

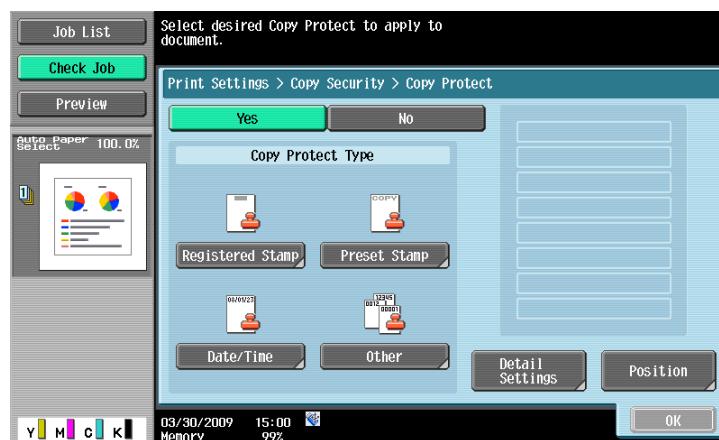

In the Copy Protect screen, you can configure the following settings.

Item	Description
[Copy Protect Type]	Select a type of copy protect to be printed.
[Detail Settings]	Press this button to specify the color, density, and text size of copy protect to be printed.
[Position]	Press this button to specify the angle and printing order of copy protect to be printed.

Copy Protect Type

Item	Description
[Registered Stamp]	Press this button to apply the stamp images that were pre-registered with the utility software. <ul style="list-style-type: none"> Use Copy Protection Utility to register stamps. For details, refer to the relevant utility software manual. Registered stamps may require multiple areas depending on their contents.
[Preset Stamp]	Press this button to apply a standard string such as Invalid Copy, Copy, or Private as a preset stamp. One stamp requires one area.
[Date/Time]	Press this button to apply the date and time the document was registered. <ul style="list-style-type: none"> [Date Format] requires one area. [Time Format] requires one area.
[Other]	Press this button to specify the job number, serial number, and distribution control number the document was registered with. <ul style="list-style-type: none"> [Job Number]: The job number for the print job is printed. A job number requires one area. [Serial Number]: The serial number assigned to this machine is printed. The serial number requires one area. The serial number is assigned at the time of shipment of this machine. For details on settings, contact your service representative. [Distribution Control Number]: The entered number of copies is printed. A distribution control number requires one area. Enter the distribution control number, and select "Number Only" or "Put zeros in front(total 8-digits)" as the output format.

Detail Settings

Press [Detail Settings] to specify the text color, density, background pattern, and other items.

Item	Description
[Text/Background Color]	Select the text and background colors from black, magenta, or cyan.
[Density]	Select the density from the light, standard, or dark.
[Copy Protect Pattern]	Select the pattern and contrast to be applied when the copy is reproduced. Select the pattern from Emboss Text or Emboss Background.
[Text Size]	Select the printing text size from Minimal, Standard, or Large.
[Pattern Overwrite]	Select pattern printing from Front (Overwrite) or Back.
[Background Pattern]	Select the background pattern from eight types.

Position

In the Copy Protect setting screen, press [Position] to specify the print position by angling the selected stamp or leaving a space.

Configure the following settings.

- Setting an angle of the copy protect within the area (+45 degrees/0 degrees/-45 degrees)
- Inserting a space between copy protects
- Reordering printing order of copy protect
- Deleting the copy protect or space

Item	Description
[Change Pos./Delete]	Select a copy protect to be changed, and then press [Change Position]/[Insert Space]/[Delete].

7.4.11 Stamp/Composition - Copy Security - Copy Guard

To prevent unauthorized copying, this function prints a text such as "Invalid Copy" or "Private" or information such as Date/Time on all pages of paper as a copy guard (copy inhibit information) when printing. A page with a copy guard printed on it cannot be copied or saved in a User Box.

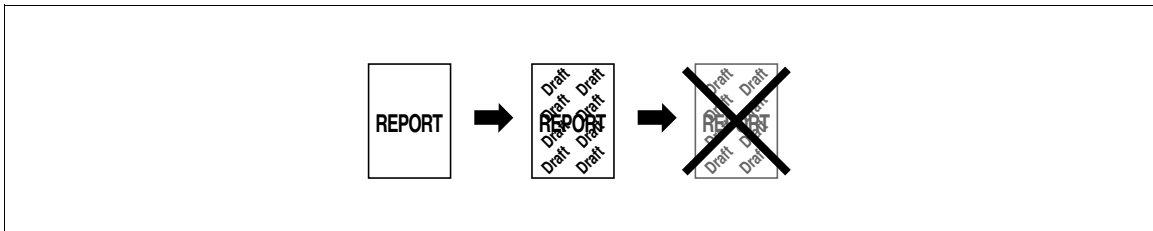

Configure the setting for the copy guard to be applied. You can apply up to 6 copy guards.



For Copy Guard, you can configure the following settings.

Item	Description
[Copy Guard Type]	Select a type of copy guard.
[Detail Settings]	Specify the color, pattern, and text size of the selected copy guard.

Copy Guard Type

Item	Description
[Preset Stamp]	Press this button to apply a standard string such as Invalid Copy, Copy, or Private as a preset stamp. One stamp requires one area.
[Date/Time]	Press this button to apply the date and time the document was registered. <ul style="list-style-type: none"> [Date Format] requires one area. [Time Format] requires one area.
[Other]	Press this button to specify the job number, serial number, and distribution control number the document was registered with. <ul style="list-style-type: none"> [Job Number]: The job number for the print job is printed. A job number requires one area. [Serial Number]: The serial number assigned to this machine is printed. The serial number requires one area. The serial number is assigned at the time of shipment of this machine. For details on settings, contact your service representative. [Distribution Control Number]: The entered number of copies is printed. A distribution control number requires one area. Enter the distribution control number, and select "Number Only" or "Put zeros in front(total 8-digits)" as the output format.

Detail Settings

Press [Detail Settings] to specify the text color, contrast, background pattern, and other items.

Item	Description
[Text/Background Color]	Select the text and background colors from black, magenta, or cyan.
[Copy Guard Pattern]	Specify the contrast of a copy guard. [Emboss Background] is selected for the pattern.
[Text Size]	Select the printing text size from Minimal, Standard, or Large.
[Background Pattern]	Select the background pattern from eight types.

7.4.12 Stamp/Composition - Copy Security - Password Copy

To prevent unauthorized copying, this function configures stamp settings for a text such as "Invalid Copy" or "Private" or information such as Date/Time on all pages of paper, and prints with an embedded password.

When a sheet of paper with an embedded password is copied, scanned, or saved in a User Box, the currently running job is suspended, and the password entry screen is displayed. In this case, enter the password to carry out the desired operation.

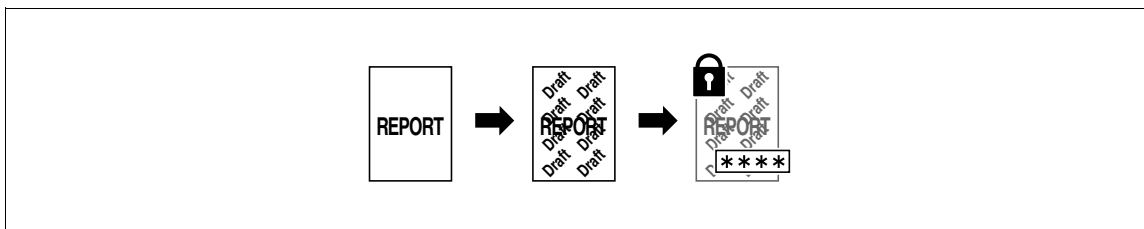

To enable Password Copy, select [Yes], and press [Password] to specify the password.

Reference

- For confirmation, enter the password twice in the control panel.

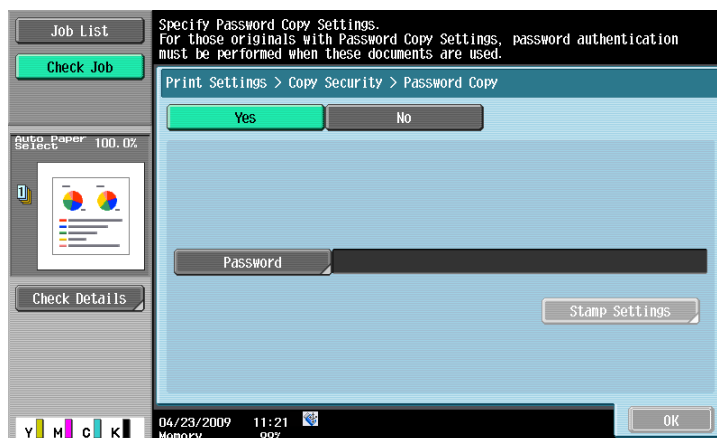

If a password is specified, you can configure a stamp. You can apply up to 6 stamps.

Item	Description
[Stamp Type]	Select the type of stamps.
[Detail Settings]	Specify the color, pattern, and text size of the selected stamp.

Stamp Type

Item	Description
[Preset Stamp]	Press this button to apply a standard string such as Invalid Copy, Copy, or Private as a preset stamp. One stamp requires one area.
[Date/Time]	Press this button to apply the date and time the document was registered. <ul style="list-style-type: none"> • [Date Format] requires one area. • [Time Format] requires one area.
[Other]	Press this button to specify the job number, serial number, and distribution control number the document was registered with. <ul style="list-style-type: none"> • [Job Number]: The job number for the print job is printed. A job number requires one area. • [Serial Number]: The serial number assigned to this machine is printed. The serial number requires one area. The serial number is assigned at the time of shipment of this machine. For details on settings, contact your service representative. • [Distribution Control Number]: The entered number of copies is printed. A distribution control number requires one area. Enter the distribution control number, and select "Number Only" or "Put zeros in front(total 8-digits)" as the output format.

Detail Settings

Press [Detail Settings] to specify the text color, contrast, background pattern, and other items.

Item	Description
[Text/Background Color]	Select the text and background colors from black, magenta, or cyan.
[Password Copy Pattern]	Specify the contrast of a pattern. [Emboss Background] is selected for the pattern.
[Text Size]	Select the printing text size from Minimal, Standard, or Large.
[Background Pattern]	Select the background pattern from eight types.

7.4.13 Stamp/Composition - Stamp Repeat

Text or an image is repeatedly printed on all pages. Copy Protect stamps are used to prevent recopying. However, Stamp Repeat stamps can be copied.

You can apply up to eight strings or stamps. If you set the angle of strings or stamps to 45 degrees (or -45 degrees), however, the number of areas in which you can place strings or stamps is limited to 4.

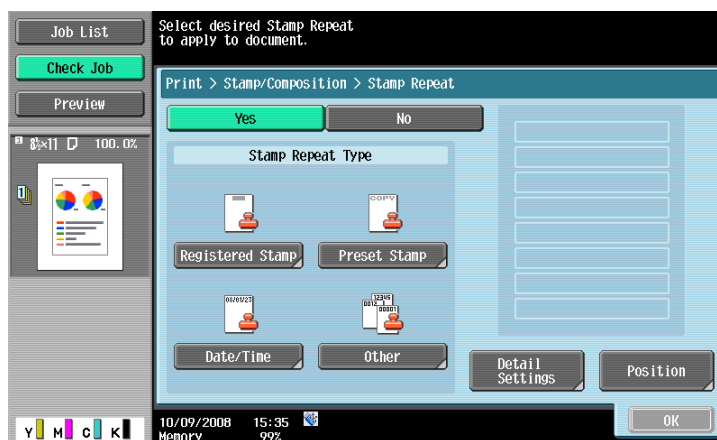

In the Stamp Repeat screen, you can configure the following settings.

Item	Description
[Stamp Repeat Type]	Select a type of stamp repeat to be printed.
[Detail Settings]	Specify the color, density, and text size of stamp repeat to be printed.
[Position]	Select the angle or printing order of stamp repeat to be printed.

Stamp Repeat Type

Item	Description
[Registered Stamp]	Press this button to apply the stamp images that were pre-registered with the utility software. <ul style="list-style-type: none"> Use Copy Protection Utility to register stamps. For details, refer to the relevant utility software manual. Registered stamps may require multiple areas depending on their contents.
[Preset Stamp]	Press this button to apply a standard string such as Invalid Copy, Copy, or Private as a preset stamp. One stamp requires one area.
[Date/Time]	Press this button to apply the date and time the document was registered. <ul style="list-style-type: none"> [Date Format] requires one area. [Time Format] requires one area.
[Other]	Press this button to specify the job number, serial number, and distribution control number the document was registered with. <ul style="list-style-type: none"> [Job Number]: The job number for the print job is printed. A job number requires one area. [Serial Number]: The serial number assigned to this machine is printed. The serial number requires one area. The serial number is assigned at the time of shipment of this machine. For details on settings, contact your service representative. [Distribution Control Number]: The entered number of copies is printed. A distribution control number requires one area. Enter the distribution control number, and select "Number Only" or "Put zeros in front(total 8-digits)" as the output format.

Detail Settings

Press [Detail Settings] to specify the text color, density, and other items.

Item	Description
[Text Color]	Select the text and background colors from black, magenta, or cyan.
[Density]	Select the density from the light, standard, or dark.
[Text Size]	Select the printing text size from Minimal, Standard, or Large.
[Pattern Over-write]	Select pattern printing from [Front (Overwrite)], [Transparent], or [Back].

Position

In the Stamp Repeat setting screen, press [Position] to determine the print position of the stamp, for example, by angling the stamp or leaving a space.

Configure the following settings.

- Setting an angle of the stamp repeat within the area (+45 degrees/0 degrees/45 degrees)
- Inserting a space between stamp repeats
- Reordering printing order of stamp repeat
- Deleting the stamp repeat or space

Item	Description
[Change Pos./Delete]	Select Stamp Repeat to be changed, and press [Change Position]/[Insert Space]/[Delete] to specify.

7.4.14 Stamp/Composition - Header/Footer

Configure settings to insert the header or footer. To insert the header or footer, you must register their contents in Administrator Settings in advance. Press Check/Change Temporarily to temporarily change and print the contents of the registered header and footer.



Reference

For details on how to register the header or footer, refer to the [User's Guide Network Scan/Fax/Network Fax Operations].

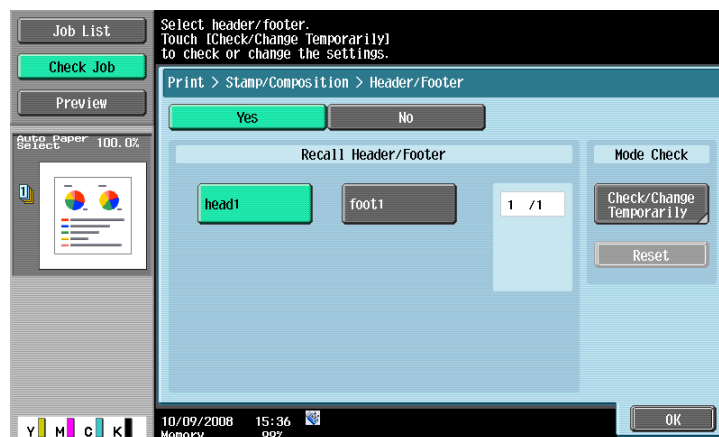

Item	Description
[Recall Header/Footer]	Select the desired ones from the registered headers and footers.
[Check/Change Temporarily]	Press this button to check or change the selected header or footer. For details, refer to page 7-32.
[Reset]	Press this button to cancel the use of the temporarily changed header or footer.

Check/Change Temporarily

In the Header/Footer setting screen, press [Check/Change Temporarily] to change the registered header or footer.

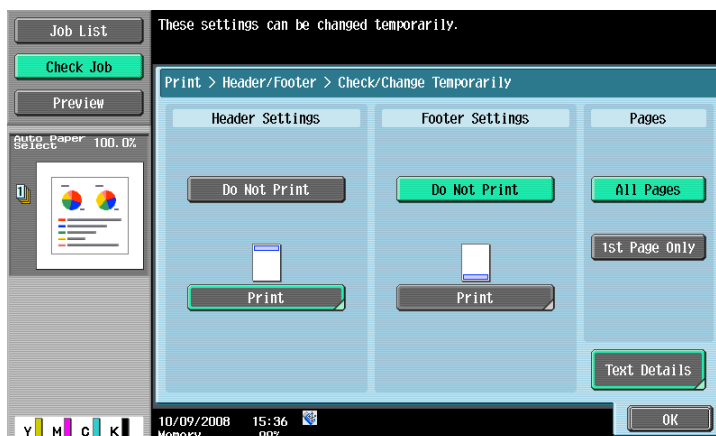

Item	Description
[Header Settings], [Footer Settings]	Specify whether to print the header and footer. Press [Print] to configure the following setting. <ul style="list-style-type: none"> [Text]: Specify a header or footer text in the touch panel. [Date/Time]: Configure the date and time settings for the header or footer. [Other]: Configure setting to add the distribution control number, job number, or serial number to the header or footer. The serial number is assigned at the time of shipment of this machine. For details on settings, contact your service representative.
[Pages]	Select whether to print the header and footer on all pages or the first page only.
[Text Details]	Specify the details of text to be printed. <ul style="list-style-type: none"> [Text Color]: Select the printing color from black, red, blue, green, yellow, cyan, or magenta. [Text Size]: Select the printing text size from 8 pt, 10 pt, 12 pt, or 14 pt. [Text Type]: Select the font type from Times Roman or Helvetica.

7.4.15 Stamp/Composition - Registered Overlay

Settings

A registered image is overlaid and printed on the specified pages. Select [Yes] to use an overlay image.

Reference

- Overlay images can be registered in Copy mode as well as in User Box mode. An overlay image that was registered in Copy mode can be used for printing a document in the User Box. An overlay image that was registered from an image in the User Box can be used in Copy mode.



Reference

For details on how to register an overlay image, refer to page 7-79.

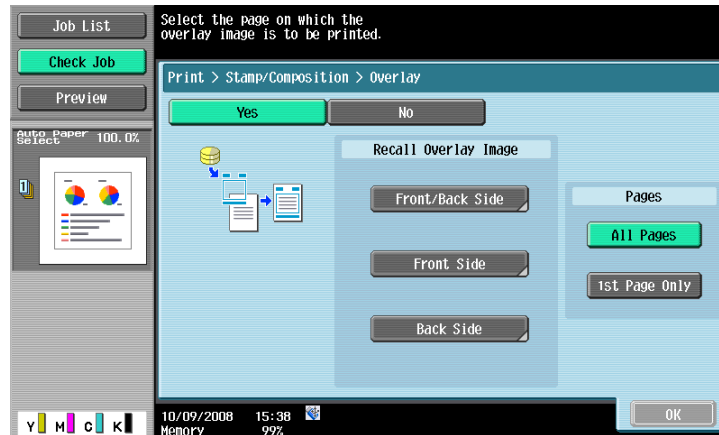

Item	Description
[Recall Overlay Image]	Specify whether to print a registered overlay image on the front or back side. Press an item to select an overlay image and configures its setting. For details, refer to page 7-34.
[Pages]	Select whether to print the selected overlay image on all pages or the first page only.

Overlay Setting

Select an overlay image and configure its settings. You can also preview the image.

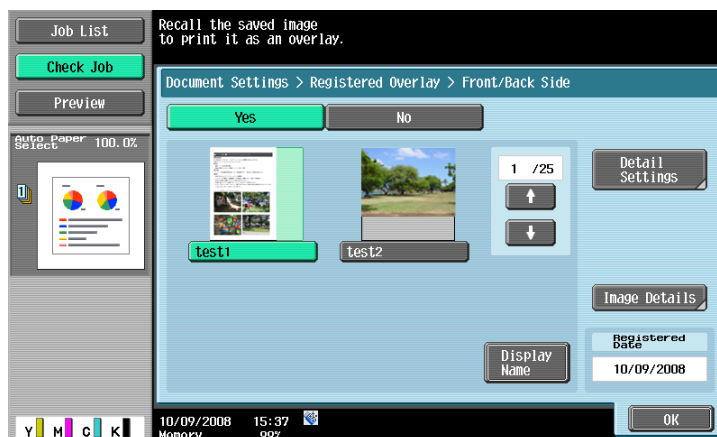

Item	Description
[Thumbnail View]/[Display Name]	In the thumb-nail view, you can check overlay images. In the Display Name mode, you can check overlay images using their file names. Select the desired overlay image.
[Detail Settings]	Press this button to specify how to compose an overlay image. <ul style="list-style-type: none"> • [Density]: Use the keypad to enter the density of an overlay image (using a value between 20 to 100%). • [Color]: Select the color of overlay image from full color, black, red, blue, green, yellow, cyan, or magenta. • [Composition]: Select Transparent, Background Composition (Original) or Back to specify how to compose an overlay image.
[Image Details]	Press this button to check the details of the overlay image including the preview image, size, and color.

Reference

- The following shows three methods for composing an overlay.
 - [Transparent]: Increases the brightness of the overlay image to be superimposed. This setting prevents an original from being hidden by the composed overlay image.
 - [Background Composition (Original)]: Composes the original as the background. The overlay image is superimposed on the original when they are printed.
 - [Back]: Composes the overlay image as the background. The original is superimposed on the overlay image when they are printed.

7.5 Send

7.5.1 Overview of the Transmission Settings

You can use the following functions to send a document saved in a User Box. Using these functions enables you to easily send data by only registering destinations in this machine without transferring data via computers.

Item	Description
Fax	Sends document data by fax.
E-mail	Sends document data as an attachment file of an E-mail.
Internet Fax	Sends document data as an attachment file of an E-mail via an intranet or Internet.
IP Address Fax	Sends document data to the destination specified with the IP address (host name) or E-mail address of the destination.
PC (SMB)	Sends document data to the shared folder in the specified computer.
FTP	Sends document data to the specified FTP server.
WebDAV	Sends document data to the specified server via network.

Description of the Send tab

Press [Send] to display the following screen. The available setting items for [Transmission Settings] are as follows.



No.	Item	Description
1	[Send]	Configure the destination and other settings to send the selected documents. If you have selected multiple documents, [Document Settings] and [Application] are not available. (p. 7-37)
2	[Bind TX]	Configure the printing order or other setting to print two or more document selected. (p. 7-38)



Reference

For details on other items, refer to page 7-4.

Send

Press [Send] to display the following screen. You can configure transmission destination and additional functions.

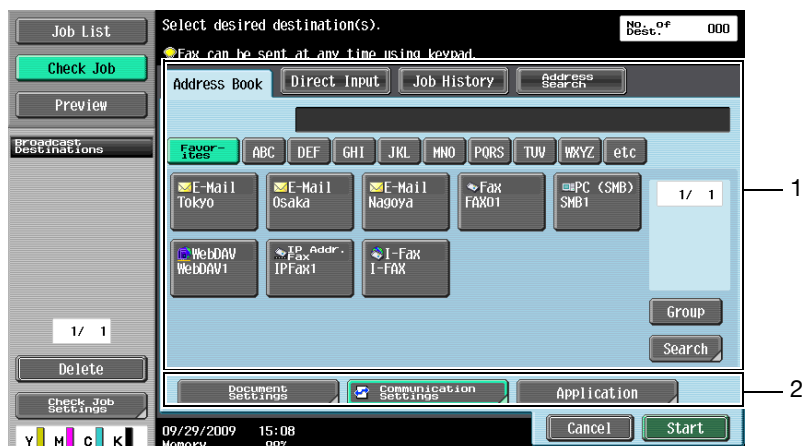

No.	Item	Description
1	Configure the destinations	Configure the destinations. (p. 7-39)
2	Configure the functions	Configure the functions that can be added when transmitting documents. (p. 7-49)

Bind TX

Press [Bind TX] to display the following screen after specifying the bind order. Some destination types or function are not displayed since multiple documents are sent.

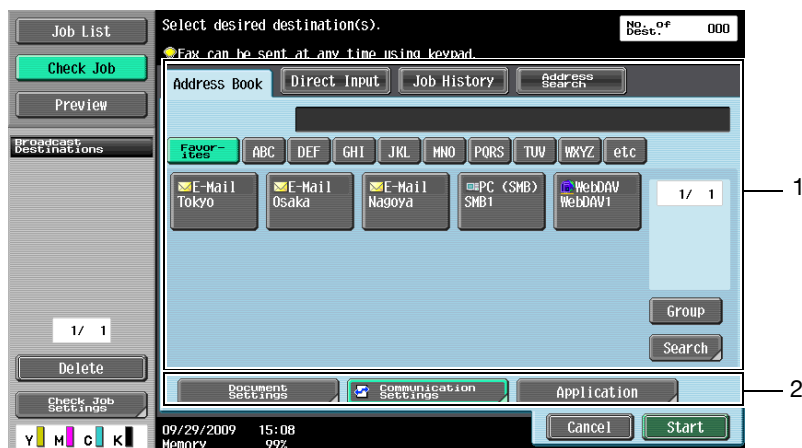

No.	Item	Description
1	Configure the destinations	Configure the destinations. (p. 7-39)
2	Configure the functions	Configure the functions that can be added when transmitting documents. (p. 7-49)

7.5.2 Transmission Settings

Press [Send] to specify destinations and functions that can be added when transmitting documents.

Reference

- [Direct Input] is not displayed when Manual Destination Input is set to Restrict in [Security Settings] in Administrator Settings.

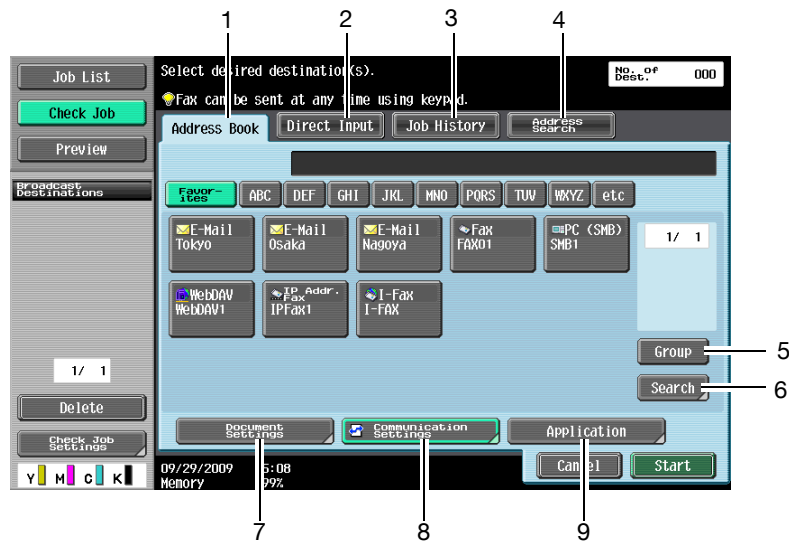

No.	Item	Description
1	[Address Book]	Press this button to select the recipient from the pre-registered destinations.
2	[Direct Input]	Press this button to directly enter unregistered destinations.
3	[Job History]	Select the recipients from the transmission log.
4	[Address Search]	Press this button to search for the registered address when the LDAP server is used.
5	[Group]	Press this button to list the registered group addresses.
6	[Search]	Press this button to search the address book for destination.
7	[Document Settings]	Press this button to specify the resolution, file type, or color when sending a document.
8	[Communication Settings]	Press this button to configure communication settings.
9	[Application]	Press this button to specify additional functions such as Stamp or Page Print.

7.5.3 Combine

Document Order

After selecting documents, press [Bind TX] to display the binding order selection screen. Documents will be printed in the order they are displayed in this screen. When this screen appears, the documents are displayed in the order they were selected.

Reference

- To change the order, select a reorder source document, then a reorder destination document.

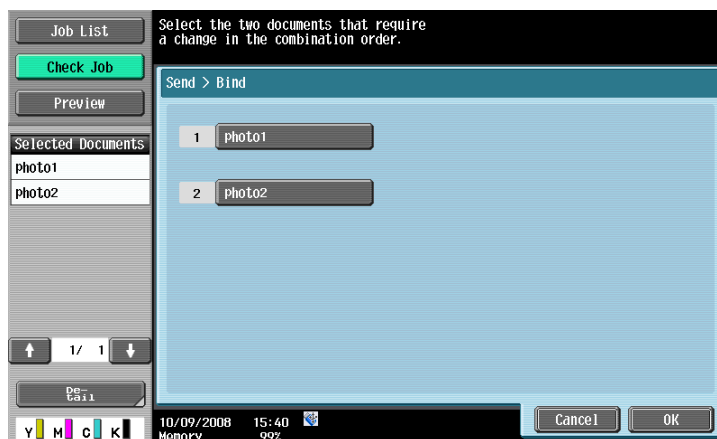

7.6 Send (Public, Personal, or Group User Box)

7.6.1 Address Book - Search

Search for transmission destinations. The following methods are available to search for the registered destinations.

Address Type

Press this button to search for the destination by address type that was specified when the destination is registered.



Reference

For details on the [Default Address Book] setting, refer to the [User's Guide Network Scan/Fax/Network Fax Operations].

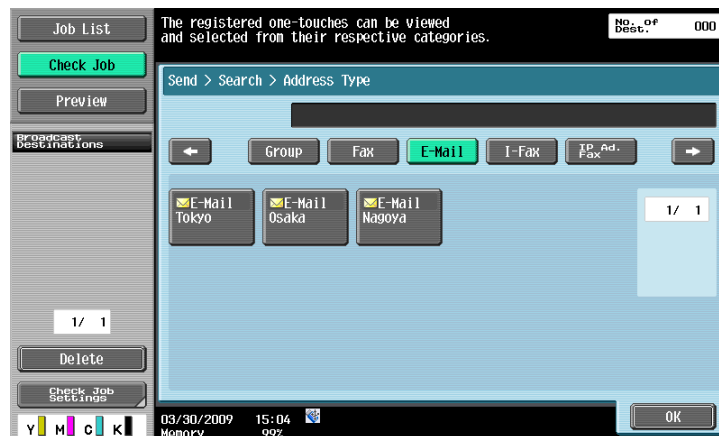

The [Address Type] screen is displayed when you press [Search] if [Default Address Book] is set to [Index] in [User Settings] - [Custom Display Settings] - [Scan/Fax Settings] in the Utility menu.

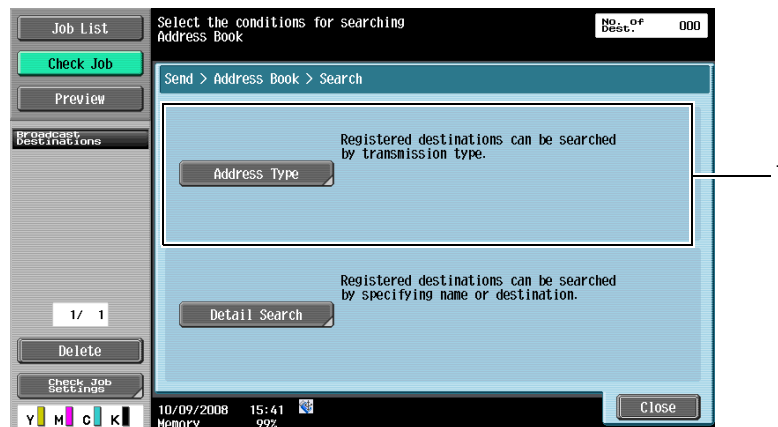

No.	Item	Description
1	[Address Type]	Registers addresses by registered type.

Index

The Index screen appears by index that was specified when they were registered.

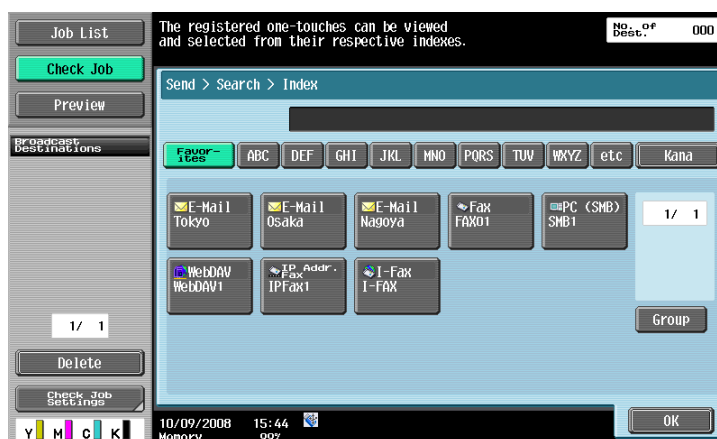

The [Index] screen is displayed when you press [Search] if [Default Address Book] is set to [Address Type] in [User Settings] - [Custom Display Settings] - [Scan/Fax Settings] in the Utility menu.

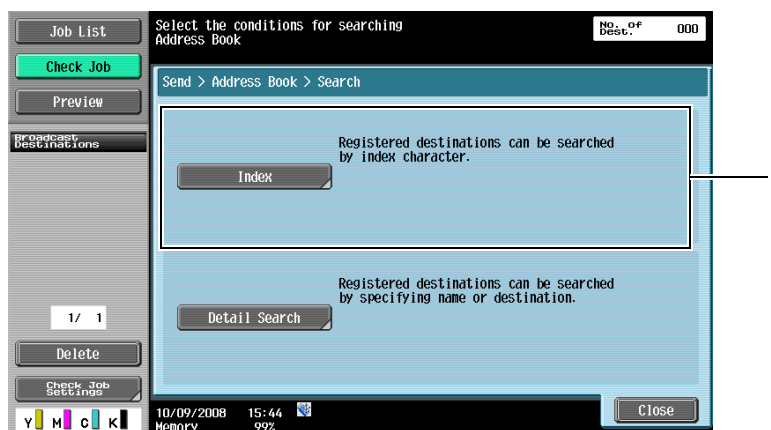

No.	Item	Description
1	[Index]	Displays addresses by registered index.

Detail Search

Enter the address name or a part of the address to search for the destination address. Select either [Name] or [Address], and enter an index.

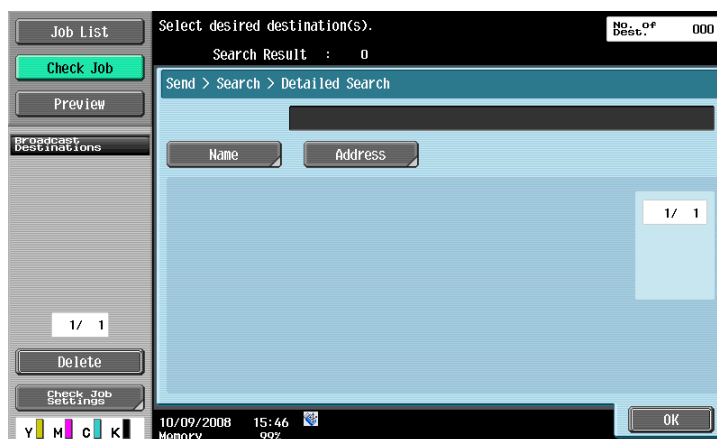

Detail Search - Search options

In the Detail Search screen, select a condition to display search options. Select the additional search conditions, and press [OK].

Reference

- To configure whether to display the search option screen and options displayed on that screen, use [Search Option Settings] in the setting menu. For details, refer to the [User's Guide Network Scan/Fax/Network Fax Operations].

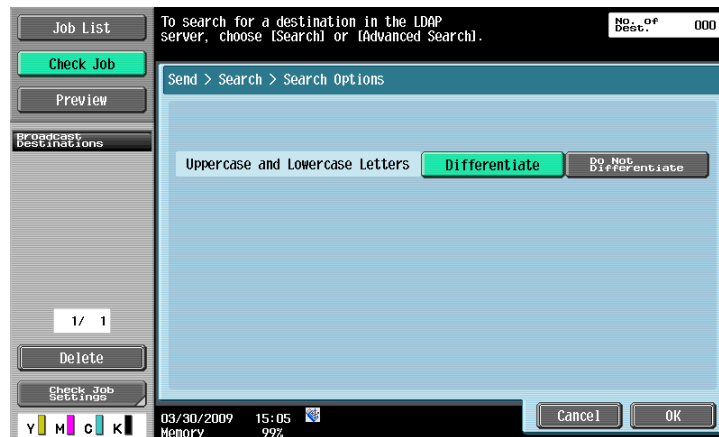

7.6.2 Direct Input

Directly enter an unregistered destination as a recipient.

Reference

- When Manual Destination Input is set to Individual Management in [Security Settings] in Administrator Settings, Direct Input is not available except for Fax.

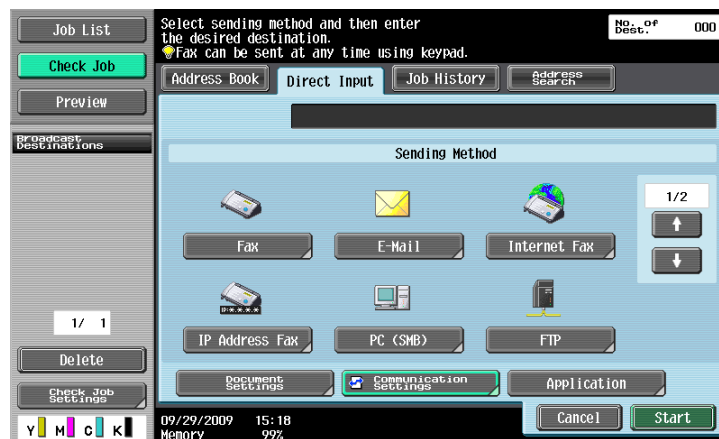

7.6.3 Direct Input - Fax

Enter the fax number in the touch panel.

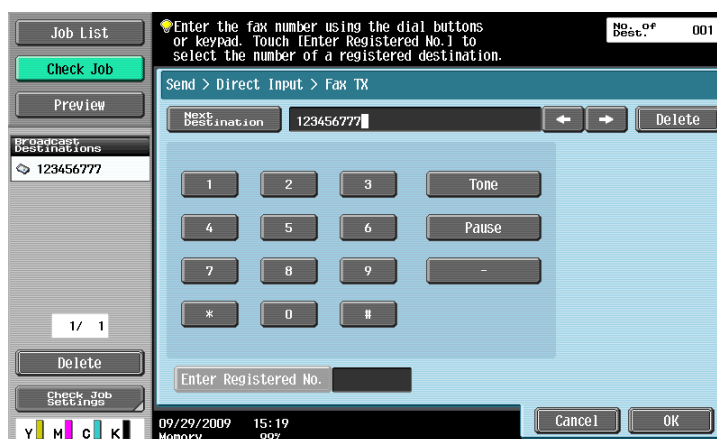

Next Destination

Press this button to continuously specify another destination.

When the Confirm Address (TX) function is specified:

You are prompted to enter the fax number again after pressing [OK]. Enter the fax number, and press [Start].

Reference

- [Next Destination] can be selected on the second input screen.



Reference

For details on the Confirm Address (TX) function, refer to the [User's Guide Network Scan/Fax/Network Fax Operations].

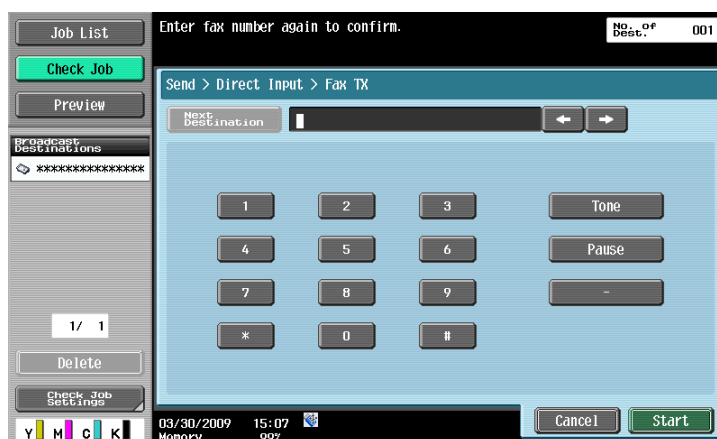

7.6.4 Direct Input - E-mail

Enter the E-mail address in the touch panel.

Reference

- You can register the frequently used user names or domain names and call them when sending E-mail messages. Before you use this function, you must register the prefix and suffix in Administrator Settings. For details on the prefix and suffix, refer to the [User's Guide Network Administrator].

Next Destination

Press this button to continuously specify another destination.

7.6.5 Direct Input - Internet Fax

Enter the E-mail address in the touch panel.

Reference

- You can register the frequently used user names or domain names and call them when sending E-mail messages. Before you use this function, you must register the prefix and suffix in Administrator Settings. For details on the prefix and suffix, refer to the [User's Guide Network Administrator].

Next Destination

Press this button to continuously specify another destination.

Receiver RX Ability

Select settings that are receivable in the Internet Fax destination. You can select multiple receivable settings.

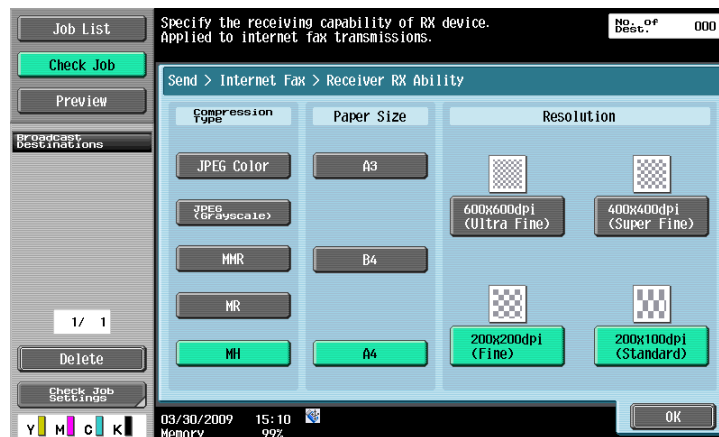

Item	Description
[Compression Type]	Select JPEG Color, JPEG (Grayscale), MMR, MR, or MH.
[Paper Size]	Select A3, B4 or A4.
[Resolution]	600×600 dpi (Ultra Fine), 400×400 dpi (Super Fine), 200×200 dpi (Fine), or 200×100 dpi (Standard).

7.6.6 Direct Input - IP Address Fax

Enter the IP Address Fax destination.

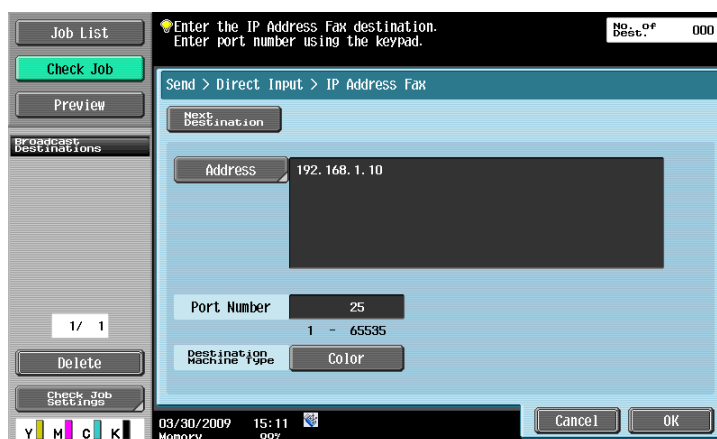

Item	Description
[Address]	Enter the IP address (host name) or E-mail address of the destination.
[Port Number]	Use the keypad to enter the sending port number (using a value from 1 to 65535).
[Destination Machine Type]	Select [Color] when the destination machine supports color printing.
[Next Destination]	Press this button to continuously specify another destination.

7.6.7 Direct Input - PC (SMB)

Directly enter the PC (SMB) address.

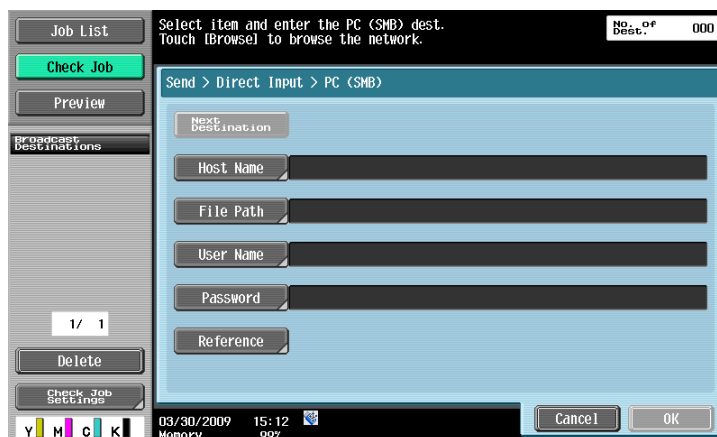

Host Name

Specify the host name or IP address of the destination in the touch panel.

File Path

Enter the path of the destination folder in the touch panel.

User Name

Enter the login user name in the touch panel.

Password

Enter the login user password in the touch panel.

Reference

Check the folder information on the destination computer.

Next Destination

Press this button to continuously specify another destination.

7.6.8 Direct Input - FTP

Directly enter the FTP address.

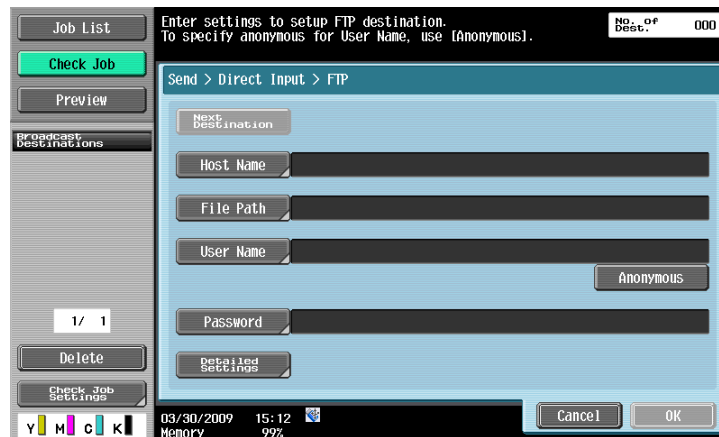

Host Name

Specify the host name or IP address of the destination in the touch panel.

File Path

Enter the path of the destination folder in the touch panel.

User Name

Enter the login user name in the touch panel. Press [Anonymous] to enter "anonymous".

Password

Enter the login user password in the touch panel.

Detail Settings

Press this button to configure the more detailed settings.

Item	Description
[Port Number]	Enter a port number.
[PASV]	Specify whether to use the PASV mode.
[Proxy]	Specify whether to use a proxy server.

Next Destination

Press this button to continuously specify another destination.

7.6.9 Direct Input - WebDAV

Directly enter the WebDAV destination.

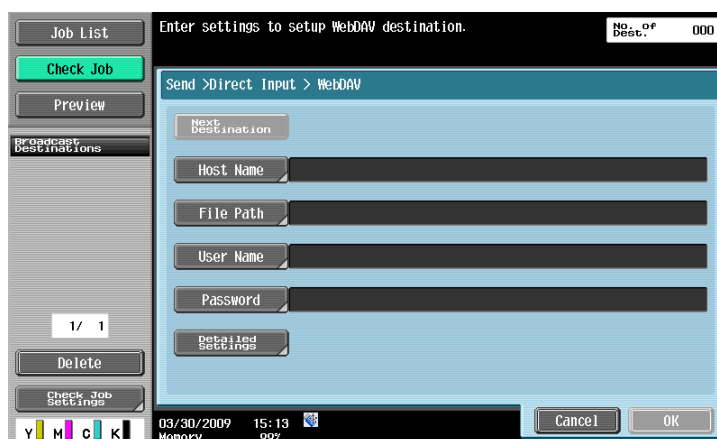

Host Name

Specify the host name or IP address of the destination in the touch panel.

File Path

Enter the path of the destination folder in the touch panel.

User Name

Enter the login user name in the touch panel.

Password

Enter the login user password in the touch panel.

Detail Settings

Press this button to configure the more detailed settings.

Item	Description
[Port Number]	Enter a port number.
[Proxy]	Specify whether to use a proxy server.
[SSL Settings]	Specify whether to use SSL for sending.

Next Destination

Press this button to continuously specify another destination.

7.6.10 Job History

Job History displays the latest five fax destinations that this machine have sent faxes to. You can select destinations from this history.

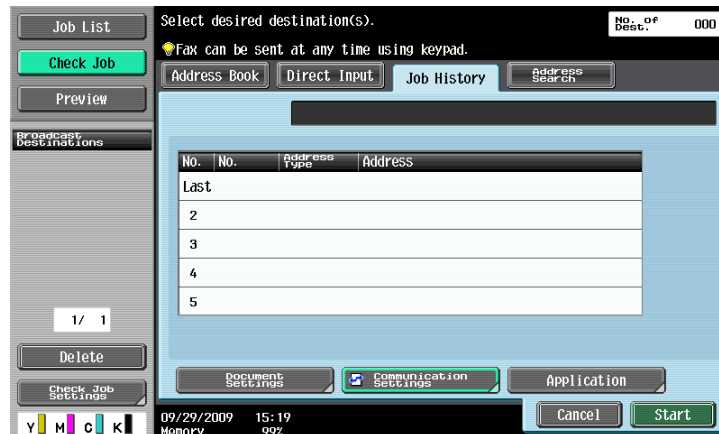

7.6.11 Address Search

The [Address Search] tab is displayed when the LDAP server is configured in Administrator Settings.

Reference

- For details on the LDAP server setting, refer to the [User's Guide Network Administrator] - Enabling LDAP.
- The display position of [Address Search] tab varies depending on user settings. For details, refer to the [User's Guide Network Scan/Fax/Network Fax Operations].

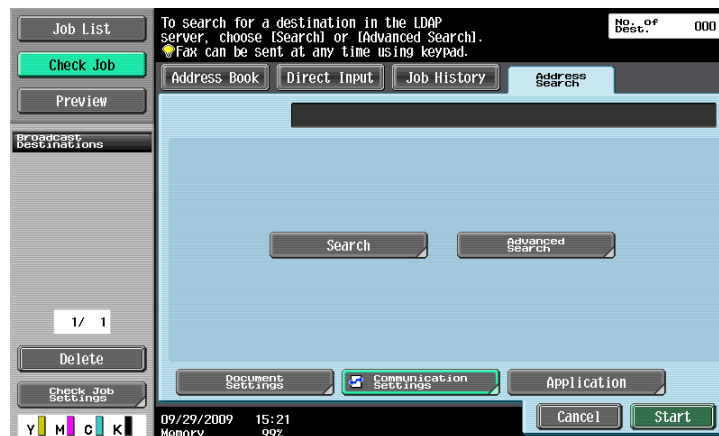

7.6.12 LDAP Search - Search

Enter a search keyword and press [Start Search] to search for the destination address in the specified LDAP server.



7.6.13 LDAP Search - Advanced Search

Specify multiple search conditions to search for the target address.

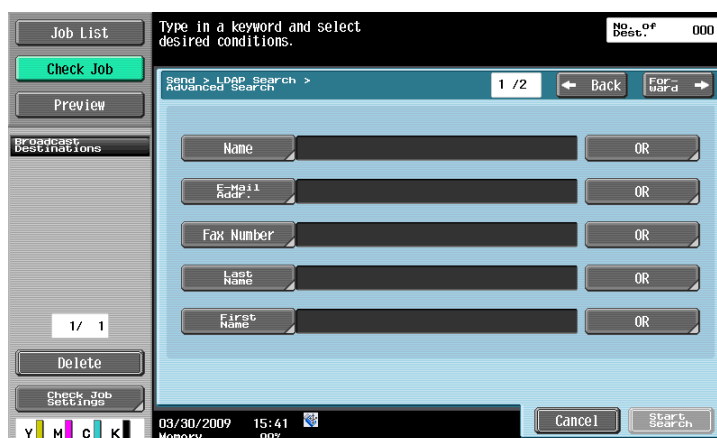

Name

Enter the name in the touch panel.

E-mail Addr.

Enter the E-mail address in the touch panel.

Fax Number

Enter the fax number in the touch panel.

Last Name

Enter the last name in the touch panel.

First Name

Enter the first name in the touch panel.

City

Enter the city name in the touch panel.

Company Name

Enter the company name in the touch panel.

Department

Enter the department in the touch panel.

OR/AND/STARTS WITH/ENDS WITH

Select the search condition from OR, AND, STARTS WITH, or ENDS WITH. When not specifying any conditions, press [No].

7.6.14 Overview of the Document Settings

Configure document settings such as the resolution or file type.

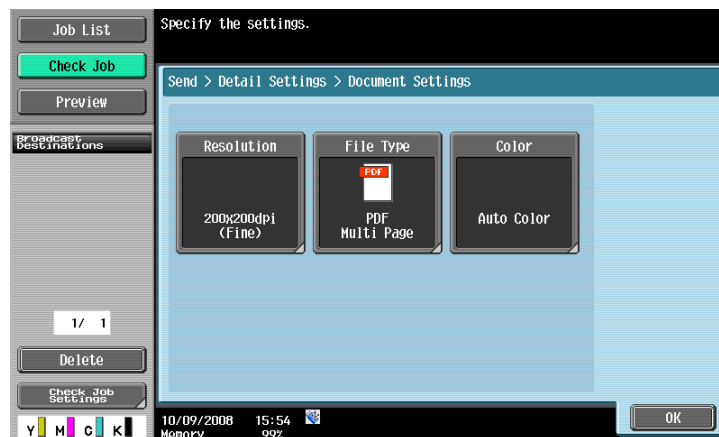

7.6.15 Document Settings - Resolution

Select the resolution for sending faxes.

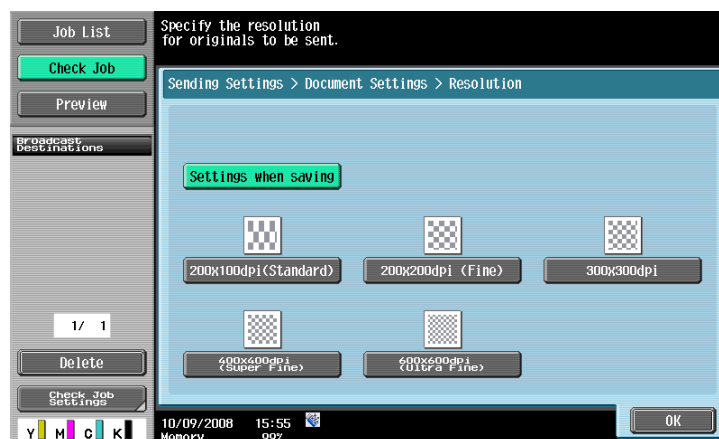

Reference

- This function is not available when performing Bind TX.

7.6.16 Document Settings - File Type

Specify the file type of data being transmitted.

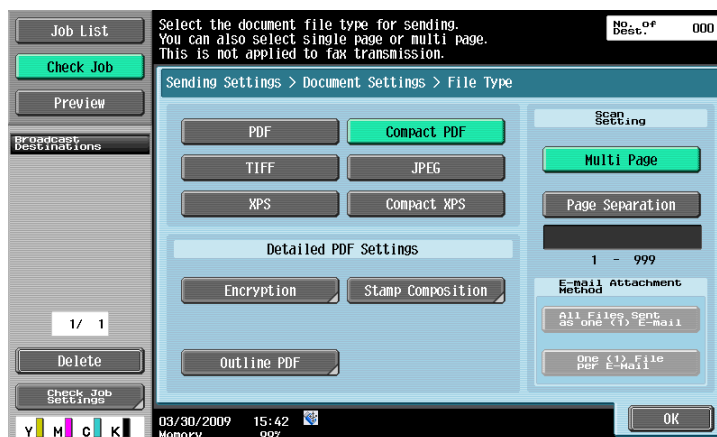

File Type

The available file types are as follows.

Item	Description
[PDF]	Saves data in PDF format.
[Compact PDF]	Further compressed PDF file.
[TIFF]	Saves data in TIFF format.
[JPEG]	Saves data in JPEG format.
[XPS]	Saves data in XPS format.
[Compact XPS]	Saves data in further compressed XPS file.

Reference

- JPEG cannot be selected when binding and sending multiple documents.
- If you select JPEG, [Page Separation] is automatically selected and set to [1 Every X Page(s)] in Scan Setting.
- You can specify the compression format when saving a TIFF file in color. For details, refer to the [User's Guide Network Scan/Fax/Network Fax Operations].

Encryption

If the [PDF] or [Compact PDF] is selected for the file format, the encryption level can be specified.



Item	Description
[Encryption Level]	Select the encryption level.
[Password]	Configure this item when you select the password for the encryption type. Enter the password necessary to open encrypted data (up to 32 characters). For confirmation, enter the password twice.
[Document Per- missions]	Configure this item when you select the password for the encryption type. Enter the password necessary to change document permissions (up to 32 characters). For confirmation, enter the password twice.

Encryption - Detail Settings

Configure the detailed permission settings when the document permission is specified in [Encryption].

<When [Low level] is selected>



<When [High level] is selected>



Item	Description
[Printing Allowed]	Select whether to allow or restrict printing data. [Low Resolution] appears when the Encryption Level is set to [High level].
[Enable copying of text, images and other content]	Select whether to allow or restrict extracting text images.

Press [Forward →] to further configure Changes Allowed settings.

<When [Low level] is selected>



<When [High level] is selected>



Item	Description
[Changes Allowed]	Select the permission level about changes to the document, including signing, entering, or commenting data.

Stamp Composition

Press this button to select how to compose the contents to be added in Stamp/Composition.

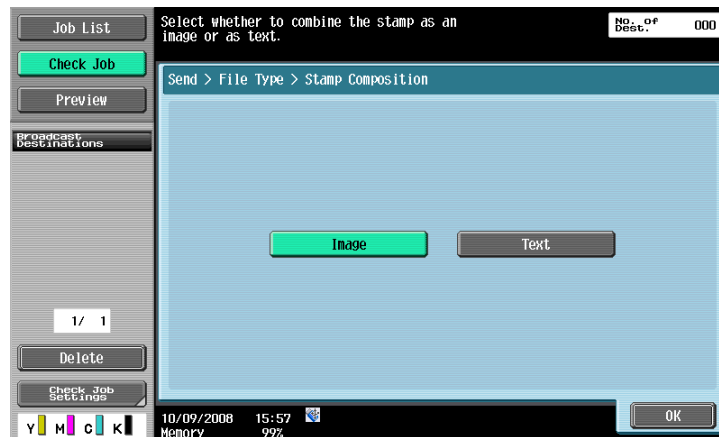

Item	Description
[Image]	Select this setting to insert the text as an image.
[Text]	Select this setting to insert the text as text. <ul style="list-style-type: none"> The date, time, page number, header, or footer is composed as text. The stamp is composed as an image.

Outline PDF

Outline PDF can be selected when Compact PDF is selected for the file type. This function performs outline processing for characters, ensuring a smooth display image. It can also be edited using an application such as Adobe Illustrator.

Reference

This function enables you to specify the accuracy of outline processing when creating outline PDF data. For details, refer to the [User's Guide Network Scan/Fax/Network Fax Operations].

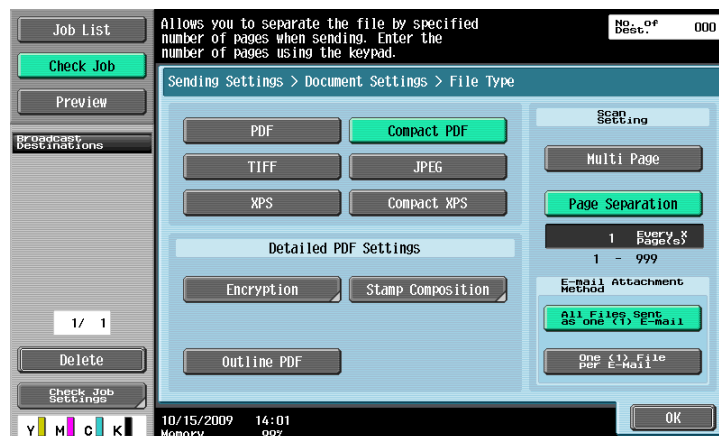

Scan Setting

Specify a collection of data.

Item	Description
[Multi Page]	Creates all the scanned originals as one file. This item cannot be specified together with the JPEG file type.
[Page Separation]	Separates the scanned data to save every specified number of pages to one file. Use the keypad to enter the number of pages to be saved in one file. <ul style="list-style-type: none"> [Page Separation] cannot be selected when binding and sending multiple documents.
[E-mail Attachment Method]	Specify the method to use to attach a file to an E-mail when Page Separation is selected. <ul style="list-style-type: none"> [All Files Sent as one (1) E-mail]: Attaches all files to one E-mail. [One (1) File per E-Mail]: Attaches one file to one E-mail.

7.6.17 Document Settings - Color

Configure color settings to send documents. Data that has been saved using this machine contains the full color data even if it is saved in gray scale or black and white; therefore, it can be changed to full color when it is sent.

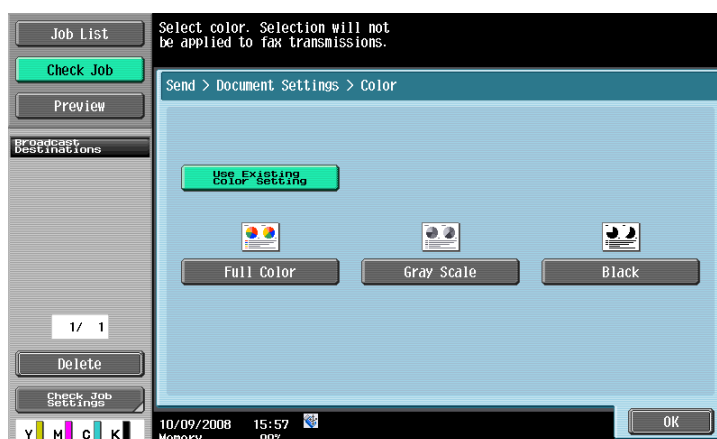

Item	Description
[Use Existing Color Setting]	Sends documents with the color setting used when they were saved.
[Full Color]	Sends documents in full color.
[Gray Scale]	Sends documents in gray scale.
[Black]	Sends documents in black and white.

Reference

- This function is not available when performing Bind TX.
- A document that has been saved in gray scale or black and white using a different machine does not contain the full color data; therefore, it cannot be changed to full color when it is sent.

7.6.18 Overview of the Communication Settings

Configure communication lines, digital signature, and other communication settings.

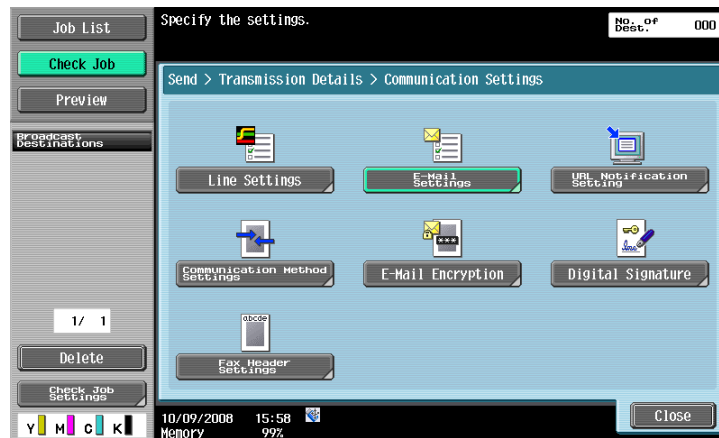

7.6.19 Communication Settings - Line Setting

Description of Line Settings

Configure line settings for fax transmission.

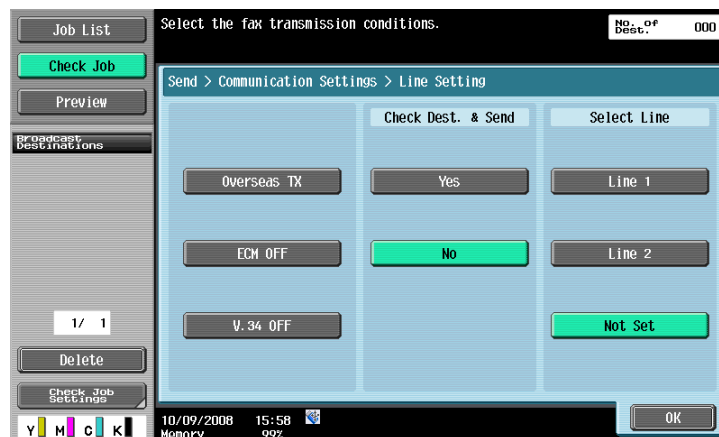

Overseas TX

Faxes are sent to locations with poor communication conditions at a lower baud rate.

Reference

- This function cannot be used together with the following functions.
 - Polling TX
 - Polling RX
 - Bulletin board

ECM OFF

The Error Correction Mode (ECM) is turned off when sending data. ECM is an error correction mode defined by ITU-T (International Telecommunication Union - Telecommunication Standardization Sector). Fax machines equipped with the ECM feature communicate with each other, confirming that the data sent is free of errors. Thus, communication can be made free from disturbances due to line noises, etc. If noises frequently occur, it may take a slightly long time to complete a communication compared with ECM OFF. After sending has been ended, this machine automatically returns to ECM ON.

Reference

- This machine sends faxes in ECM ON unless ECM OFF is specified.
- This function cannot be used together with the following functions.
 - Polling RX
 - Polling TX
 - V.34 OFF
 - Bulletin board registration
 - Bulletin board polling reception

V.34 OFF

V34 is a communication mode used for super G3 fax communication. When the remote machine or this machine is connected to a telephone line via PBX, however, you may not establish a communication in the super G3 mode depending on telephone line conditions. In this case, it is recommended that you turn V34 off to send data. After sending has been completed, this machine automatically returns to the V34 mode.

Reference

- This function cannot be used together with the following functions.
 - Polling RX
 - Polling TX
 - Bulletin board registration
 - Bulletin board polling reception
 - ECM OFF

Check Dest. & Send

The specified fax number is compared with the remote fax number (CSI) and data is sent only when those fax numbers match. If they do not match, the communication will fail; therefore preventing a sending error.

Reference

- To use the Check Dest. & Send, you must register the local fax number in the remote machine in advance.

Select Line

You can specify [Line 1] or [Line 2] for sending data when two optional **Fax Kit** are installed. Specify the line used for transmission. If you select [Not Set], either Line 1 or Line 2 whichever is not busy is used for transmission. If both lines are idle, Line 1 is used first.

Reference

- You cannot specify a line when [Line 2 Setting] is set to [RX Only] in [Multi Line Settings]. For details on the Multi Line Usage function, refer to the [User's Guide Network Scan/Fax/Network Fax Operations].
- To use two lines as external and extension lines, be sure to specify the line to be used. If you select [Not Set], a sending failure may occur.

7.6.20 Communication Settings - E-Mail Settings

E-mail Settings

Specify the document name, subject, From address and message body for sending e-mail messages.

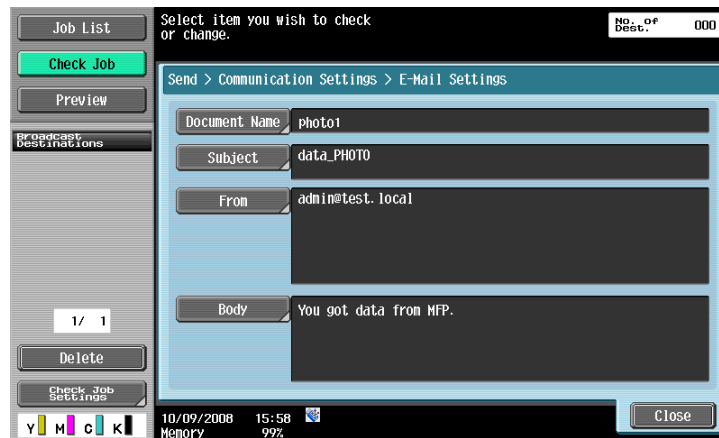

Document Name

The name of the file to be saved is displayed. This document name can also be specified in the [File Document] screen. The document name whichever is specified later will be applied to this column. You can enter up to 30 characters.

Subject

The text specified in the Utility menu is automatically displayed. To change the contents, press [Direct Input]. You can enter up to 64 characters.

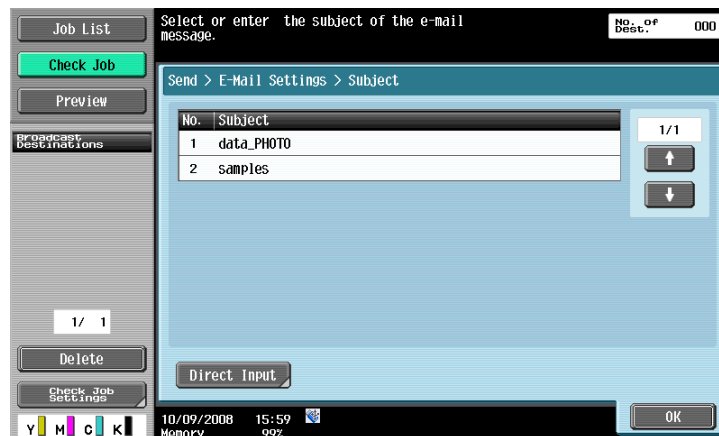

From

Displays the E-mail address of the administrator specified in the Utility menu.

Reference

- The E-mail address of this machine is used for Internet faxing.
- You cannot directly enter the address when [Change the "From" Address] is set to Restrict in Administrator Settings - [System Settings] - [Restrict User Access] - [Restrict Access to Job Settings]. For details on the [Change the "From" Address] setting, refer to the [User's Guide Network Scan/Fax/Network Fax Operations].

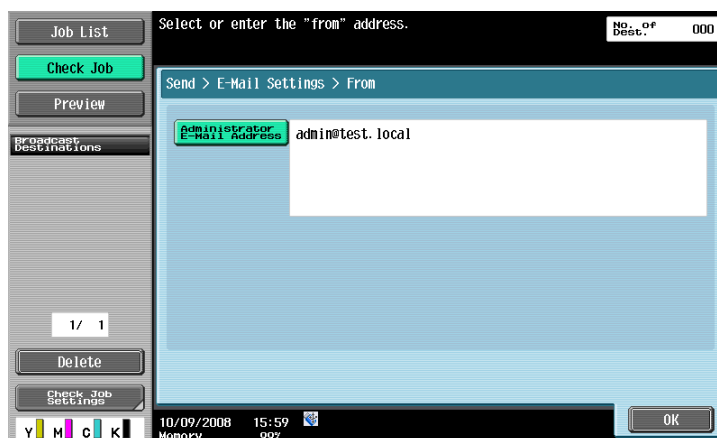

Body

The E-mail body specified in the Utility menu is displayed. To change the contents, press [Direct Input]. You can enter up to 256 characters.

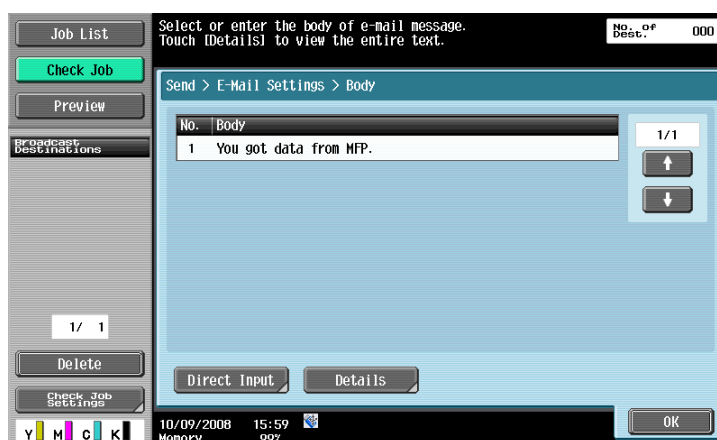

7.6.21 Communication Settings - URL Notification Setting

URL Notification

Use the URL Notification function to specify the E-mail address to be notified about the completion of a job and data location. The URL contains information for linking to a User Box. Click the link in the text to directly move to the User Box screen.

Reference

- A destination for the User Box in the main unit, FTP, PC (SMB), and WebDAV operation can be specified for the destination in URL Notification Setting.
- URL Notification Setting does not function when sending E-mails or faxes.
- If the authentication mode or User Box password is enabled, the password input screen corresponding to each respective authentication status appears. On completion of all authentication processing, the User Box screen appears.

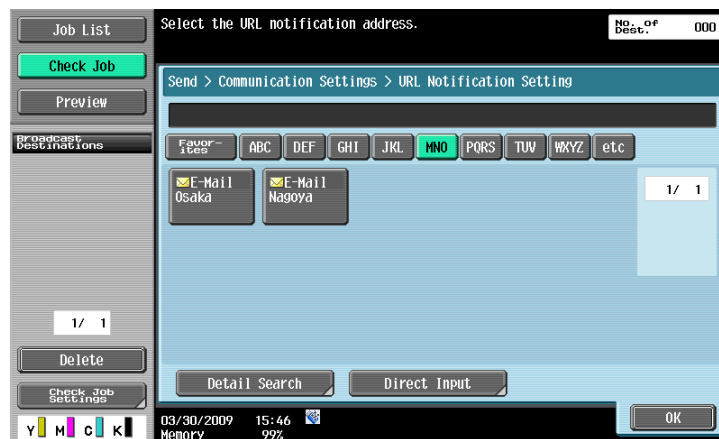

Detail Search

You can search for E-mail addresses from the registered destinations. Enter the address name or a part of the address to search for the destination address. Select either [Name] or [Destination], and enter an index.

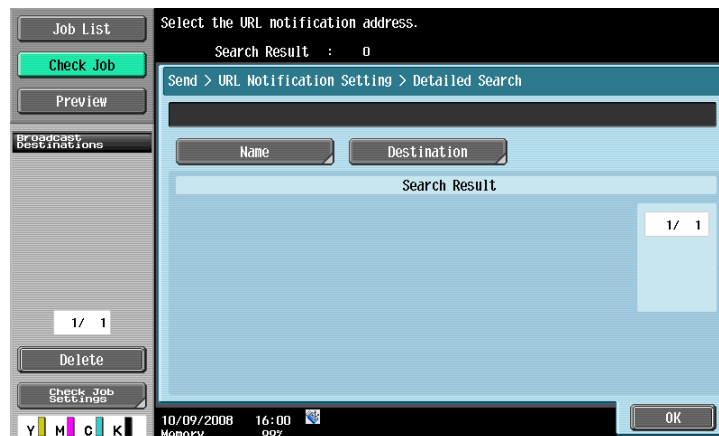

Direct Input

Enter the E-mail address in the touch panel.

Reference

- You can register the frequently used user names or domain names and call them when sending E-mail messages. Before you use this function, you must register the prefix and suffix in Administrator Settings. For details on the prefix and suffix, refer to the [User's Guide Network Administrator].

7.6.22 Communication Settings - Communication Method Settings

Specify how to send or receive data.



Timer transmission (Timer TX)

Specify the sending time. Transmitting faxes in discount telephone rate hours such as late at night or early in the morning will reduce the cost. Use the keypad to specify the communication starting time.

Reference

- It is specified in hours and minutes.
- You cannot specify the date.

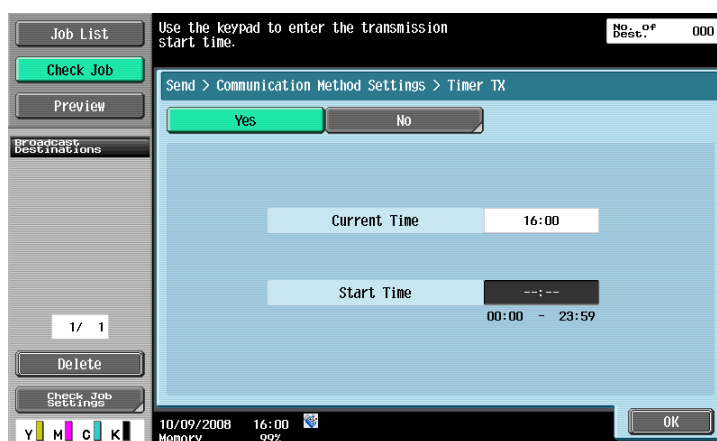

Password transmission (Password TX)

Use this function to send a document by attaching a password. If the recipient's fax machine is set to closed network reception, the sender's fax machine should transmit the same password as used for the closed network reception.

Reference

- You can use this function only when the remote machine is our model and supports the closed network reception (with password) function.
- Use the keypad to enter the password.

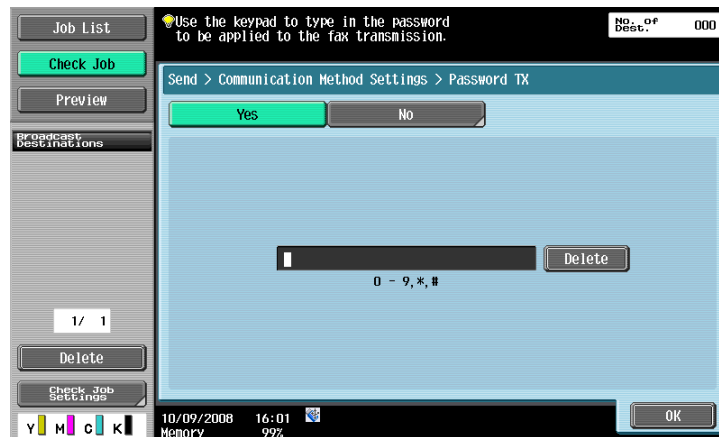

F-Code transmission (F-Code TX)

This function allows you send documents to a specific User Box of the remote machine by entering the SUB address and the password. F-Code TX can be used for the confidential transmission and relay transmission functions.

Reference

- To use the F-Code for transmission, the remote machine must support the F-Code function.

Item	Description
Confidential TX	Documents are sent to the Confidential RX User Box of the remote machine. Enter the destination User Box number in the SUB Address box and the confidential transmission password in the Password box.
Relay TX	Documents are sent to the Relay Distribution User Box of the remote machine when the remote machine supports the relay distribution function. Enter the Relay Distribution User Box number in the SUB Address box and the password in the Password box.

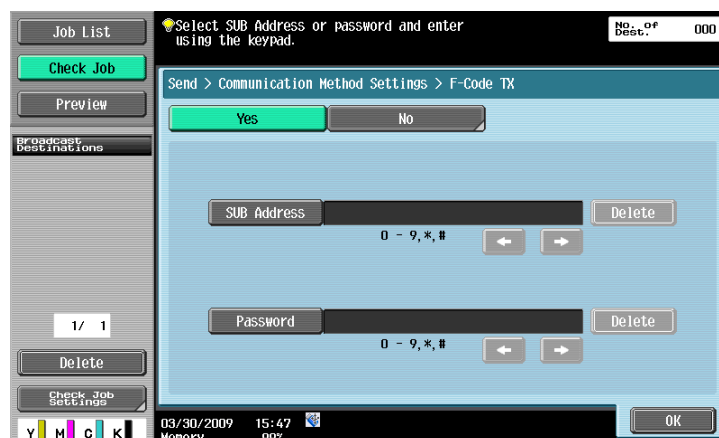

7.6.23 Communication Settings - E-mail Encryption

This item is displayed when [S/MIME Communication Settings] is set to [ON] in Administrator Settings - [Network Settings] - [E-Mail Settings]. Specify whether to encrypt E-mails to be sent from this machine.



Reference

For details on the S/MIME Communication Settings, refer to the [User's Guide Network Administrator].

7.6.24 Communication Settings - Digital Signature

This item is displayed when [S/MIME Communication Settings] is set to [ON] in Administrator Settings - [Network Settings] - [E-Mail Settings]. Select whether to add a digital signature to E-mails to be sent from this machine.

Reference

- You may not be able to add a digital signature or you may be forced to add a digital signature depending on the S/MIME communication settings.



Reference

For details on the S/MIME Communication Settings, refer to the [User's Guide Network Administrator].

7.6.25 Communication Settings - Fax Header Settings

Specify whether to attach sender information (TTI) when sending documents. Select the sender name from the sender name list.

Reference

- To register the contents of the header information to be added to the original, use [Header Information] in the Utility menu. For details, refer to the [User's Guide Network Scan/Fax/Network Fax Operations].
- To register how the header information will be added, use [Header/Footer Position] in the Utility menu. For details, refer to the [User's Guide Network Scan/Fax/Network Fax Operations].

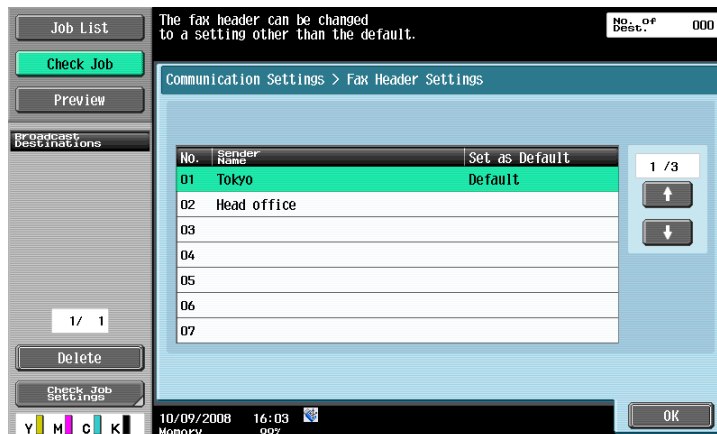

7.6.26 Overview of the Application settings

Configure the other settings (Stamp/Composition, and Send & Print) that are available for sending documents.

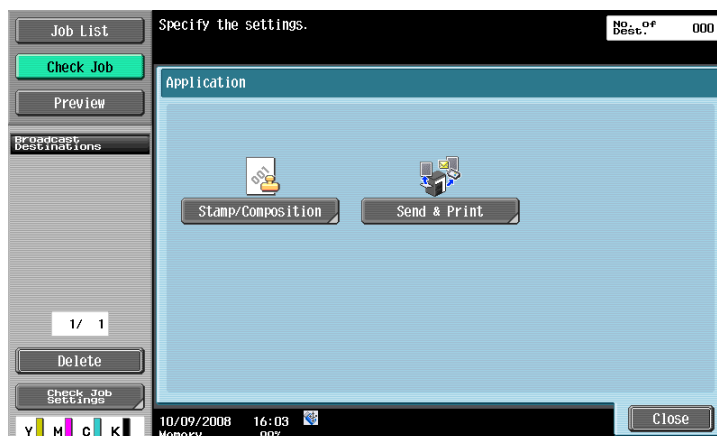

7.6.27 Application - Stamp/Composition - Date/Time

For the setting procedure, refer to page 7-22.

7.6.28 Application - Stamp/Composition - Page Number

For the setting procedure, refer to page 7-23.

7.6.29 Application - Stamp/Composition - Stamp

For the setting procedure, refer to page 7-24.

7.6.30 Application - Stamp/Composition - Header/Footer

For the setting procedure, refer to page 7-31.

7.6.31 Application - Send & Print

Specify whether to print documents while being sent. Also configure print settings.

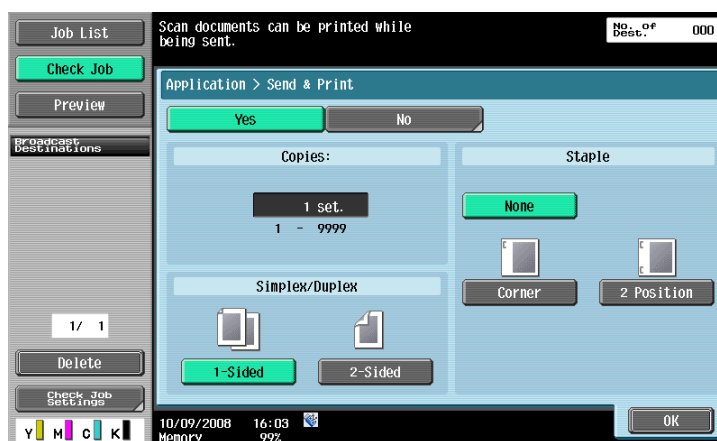

Item	Description
[Copies]	Use the keypad to enter the number of copies. A number between 1 and 9999 can be specified.
[Simplex/Duplex]	Select 1-Sided or 2-Sided.
[Staple]	Select whether to staple the printed sheets.
[Staple - Position Setting]	If you select the type of stapling, specify the position.

7.7 Filing Settings (Public, Personal, or Group User Boxes)

7.7.1 Overview of the Filing Settings

You can rename or delete documents saved in a Public, Personal, or Group User Box so that the documents in the box are organized. The available functions are as follows.

Item	Description
Delete	Deletes an unnecessary document such as a document that you have printed or sent.
Edit Name	Renames a saved document.
Move	Moves the data of a saved document to another Public, Personal, or Group User Box.
Copy	Copies the data of a saved document to another Public, Personal, or Group User Box.
Save in external memory	Saves a document from a User Box into the external memory, which is connected to this machine.
Document Details	Enables you to check the date and time a document has been saved as well as a preview image.

Description of the Filing Settings tab

Press [Filing Settings] to display the following screen. The available setting items for [Filing Settings] are as follows.



No.	Item	Description
1	[Delete]	Deletes the selected document.
2	[Edit Name]	Renames the selected document.
3	[Move]	Configure settings to move the selected document.
4	[Copy]	Configure settings to copy the selected document.
5	[Save to External Memory.]	Saves the selected document in the external memory.



Reference

For details on other items, refer to page 7-4.

7.7.2 Deleting documents

You can delete unnecessary files, for example the files you have already printed. You can select multiple files and delete them at the same time. After checking document details, press [Delete].



7.7.3 Edit Name

Renames a saved document. Enter a new name in the touch panel.

Reference

- The new document name will be used as the file name when it is set. Note that when you rename the document that you plan to send, consider the naming and other conditions forced by the destination server.
- If necessary, you can rename the document just before you send it.

7.7.4 Moving documents

Move a saved document to another User Box. For the destination User Box, a Public, Personal, or Group User Box can be selected. Select the destination User Box, check document data, and then press **Start** on the control panel or [Start] in the touch panel.

Reference

- The contents displayed in a Personal or Group User Box vary depending on the logged in user.
- You do not need to enter the password even if it is specified in the destination User Box.

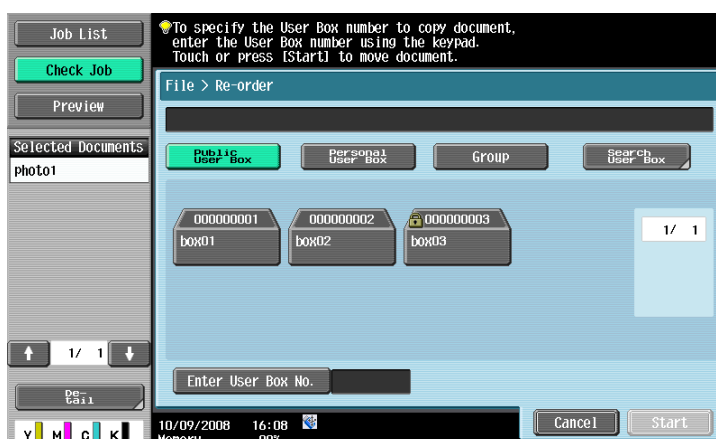

7.7.5 Copy

Copy the data of a saved document to another User Box. For the destination User Box, a Public, Personal, or Group User Box can be selected. Select the destination User Box, check document data, and then press **Start** on the control panel or [Start] in the touch panel.

Reference

- The contents displayed in a Personal or Group User Box vary depending on the logged in user.
- You do not need to enter the password even if it is specified in the destination User Box.

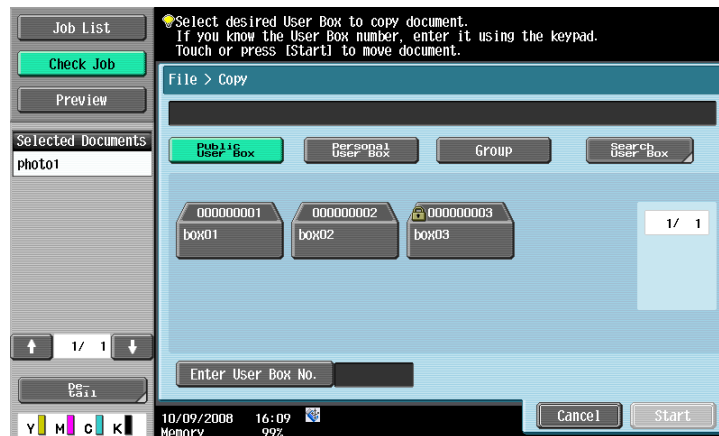

7.7.6 Save in external memory

You can save a document stored in a User Box to the external memory. Pressing [Document Settings], to configure the settings of a document to be saved.

Reference

- For information on the external memory, refer to page 7-100.
- Multiple documents can be saved collectively.
- A document cannot be renamed while it is being saved. Before saving a document, change the file name as appropriate.

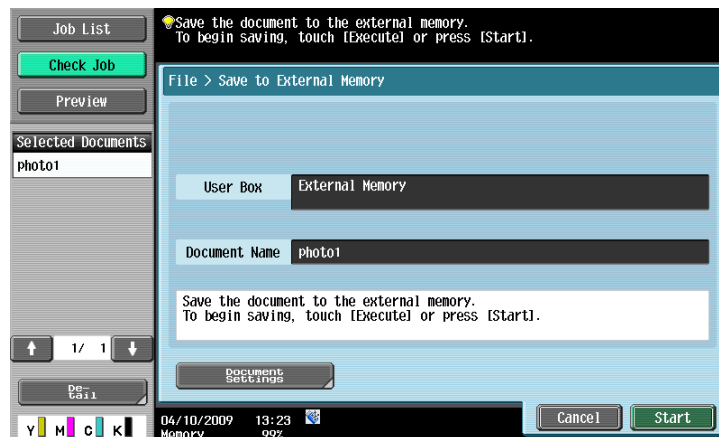

Document Settings

You can specify the resolution, file type, and color of the document to be saved. If you select multiple documents, settings are reflected in all documents.

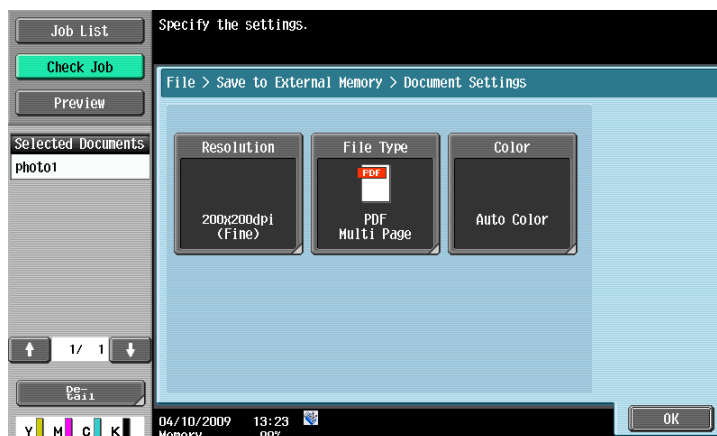

Document Settings - Resolution

Select the resolution of the document to be saved.

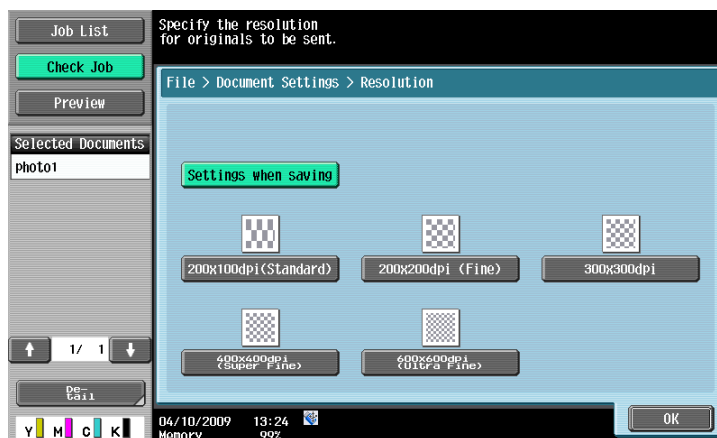

Document Settings -File Type

When specifying the file type, select [Yes]. The available setting items are as follows.

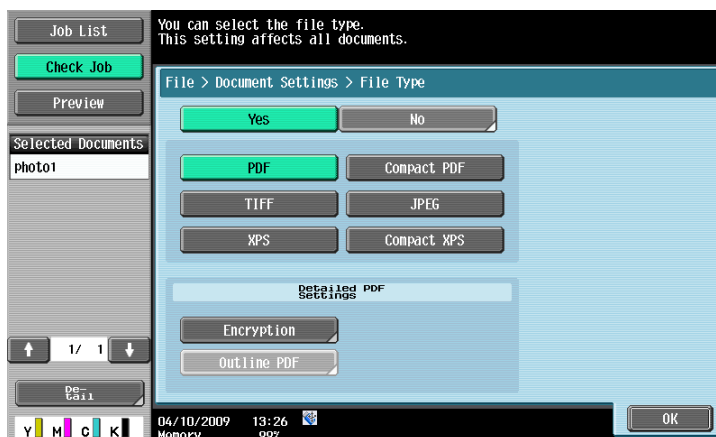

Item	Description
[File Type]	Select the file type for the file to be saved.
[Encryption]	If the PDF or Compact PDF is selected for the file format, the encryption level can be specified. For details, refer to page 7-51.
[Outline PDF]	Configure this item when you select Compact PDF for the file type. For details, refer to page 7-53.

Document Settings - Color

For the setting procedure, refer to page 7-54.

7.7.7 Document Details

Check the details of a saved document in the touch panel.

Displaying detailed information

Select a document, and press [Document Details] to check. The following information is displayed.

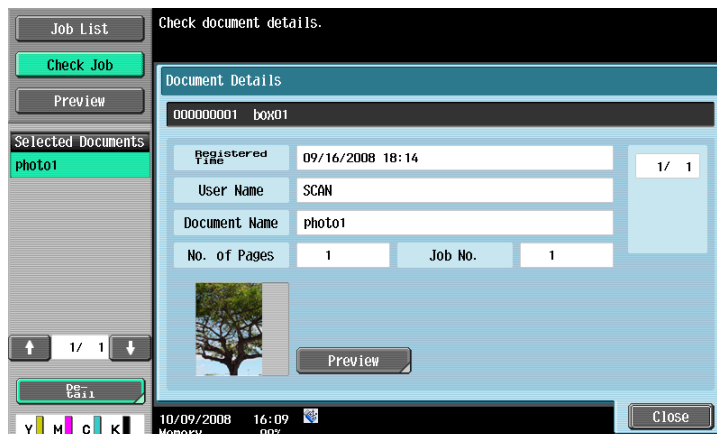

Item	Description
[Registered Time]	Displays the date and time the document was registered.
[User Name]	Displays the user name or mode (SCAN, COPY, or PRINT) by which the document was registered.
[Document Name]	Displays the name of the document.
[No. of Pages]	Displays the number of pages in the document.
[Job No.]	Displays the job number when the document was registered.
[↑][↓]	If multiple documents are selected, use [↑] or [↓] to switch them.
[Preview]	Press this button to change to the Preview screen. For details, refer to page 7-70.

Preview

In the Document Details screen, press [Preview] to check the preview image of the saved document. You can view the image at full size or at a size of 2, 4 or 8 times the normal size. After you have changed the display size, use the scroll bars located in the right and the bottom of the image to view to the desired portion.

Reference

- For a document with multiple pages, only the image of the first page can be viewed.

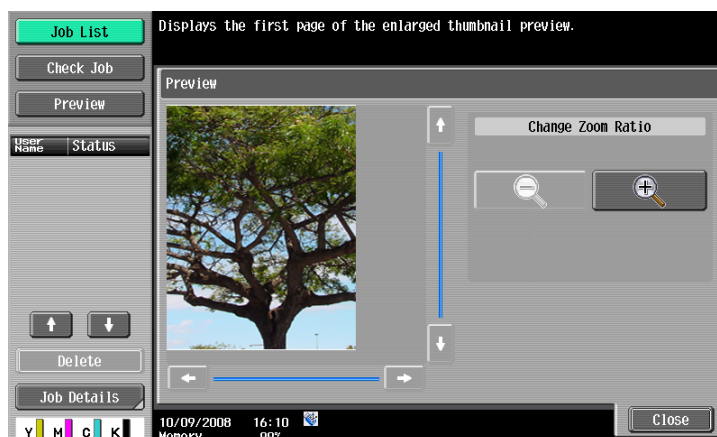

7.8 Application

7.8.1 Overview of the Application settings

You can edit a document saved in a Public, Personal, or Group User Box by changing the order of or delete pages in the document. You can also register the image of a saved document to be overlaid on the printed data. The available functions are as follows.

Item	Description
Edit Document	Deletes, rotates, or moves the selected page.
Register Overlay	Registers the image of a saved document to be overlaid on the printed data.
Document Details	Enables you to check the date and time a document has been saved as well as a preview image.

Description of the Application tab

Press [Application] to display the following screen. The available setting items for [Application Settings] are as follows.

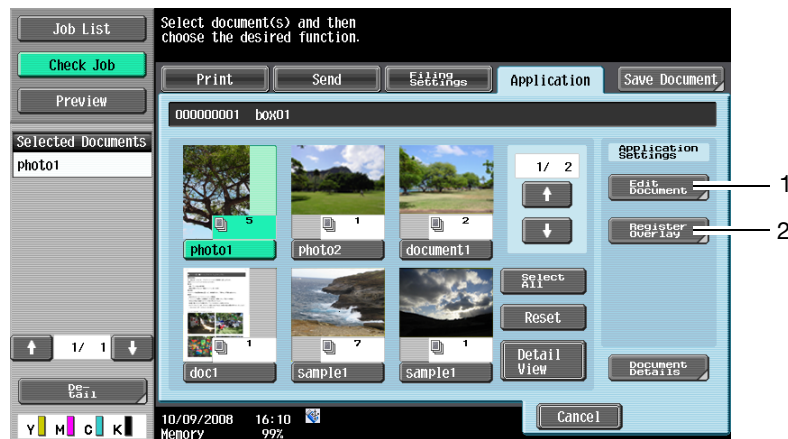

No.	Item	Description
1	[Edit Document]	Deletes, rotates, or moves the selected page.
2	[Register Overlay]	Registers the image of a saved document to be overlaid on the printed data.



Reference

For details on other items, refer to page 7-4.

7.8.2 Edit Document

Select a document and press [Edit Document]. The Edit Document screen is displayed. To view the image of a document page before editing it, press the [Preview /Set Range]. For details, refer to page 7-77.

Edit Document - Delete Page

You can delete a specific page from a saved document. For example, you can delete blank pages to reduce the amount of data.

- ✓ If you delete the only page of a document, the whole document will be deleted.
- ✓ You will be unable to undo the deletion or restore the deleted pages because they are overwritten when they are deleted. If you will need the unchanged version of the document, make a backup copy of the document in advance. For details on how to copy a document, refer to page 7-67.

- 1 Select a page to be deleted, and then press [Delete Page].
 - To select only odd pages, press [Odd Page].
 - To select only even pages, press [Even Page].
 - After selecting [Odd Page] or [Even Page], you can use a page key to select the desired page or cancel the selection.

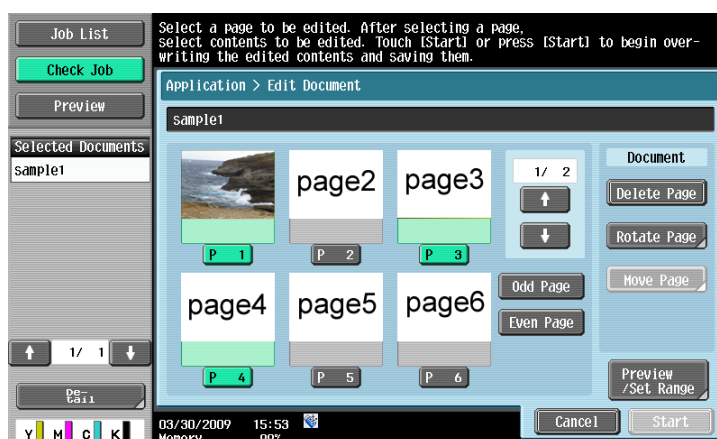

- 2 Check that the specified page has been deleted from the screen.
 - At this time, the specified page is not deleted from document data.
 - In this example, the specified pages (pages 1, 3, and 4) have been deleted.

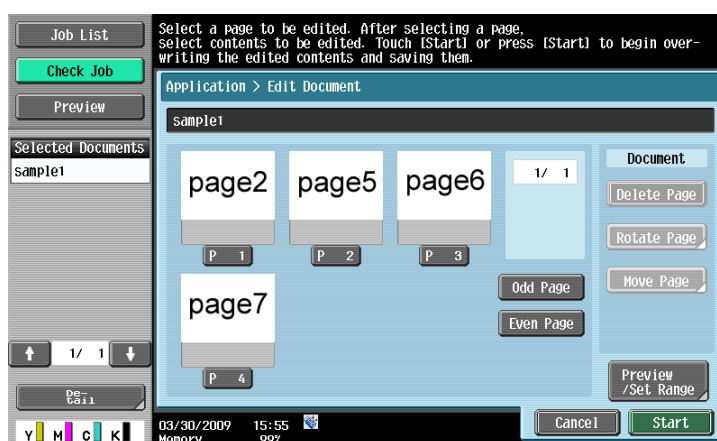

- 3 To completely delete the pages, press [Start] or the **Start** key on the control panel.
 - To cancel the deletion, press [Cancel] to return to the Application screen.

- 4 Check the information of the displayed screen. To delete the pages, select [Save].
 - To cancel the deletion, press [Do Not Save] to return to the Edit Document screen.

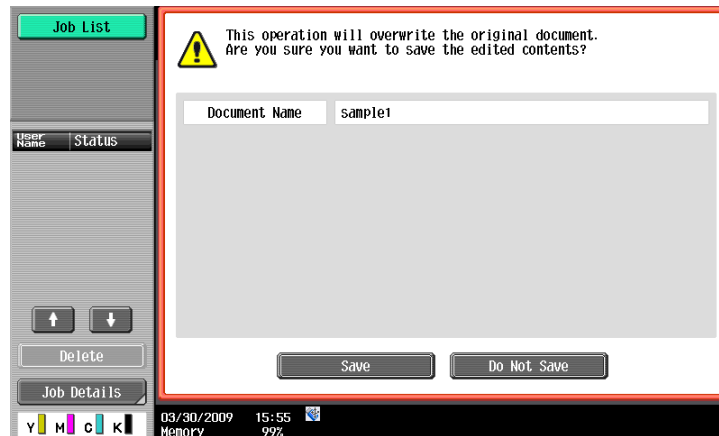

The selected pages are deleted and the document is saved.

Edit Document - Rotate Page

You can rotate the specified pages in a saved document. When a double-sided original has been scanned, the top and bottom may be reversed page by page or the orientation may be different depending on the original orientation. In this case, you can rotate selected pages so that the whole document will be viewed more easily.

- ✓ You will be unable to restore the pages because they are overwritten when they are rotated. If you will need the unchanged version of the document, make a backup copy of the document in advance. For details on how to copy a document, refer to page 7-67.

- 1 Select a page to be rotated, and then press [Rotate Page].
 - To select only odd pages, press [Odd Page].
 - To select only even pages, press [Even Page].
 - After selecting [Odd Page] or [Even Page], you can use a page key to select the desired page or cancel the selection.

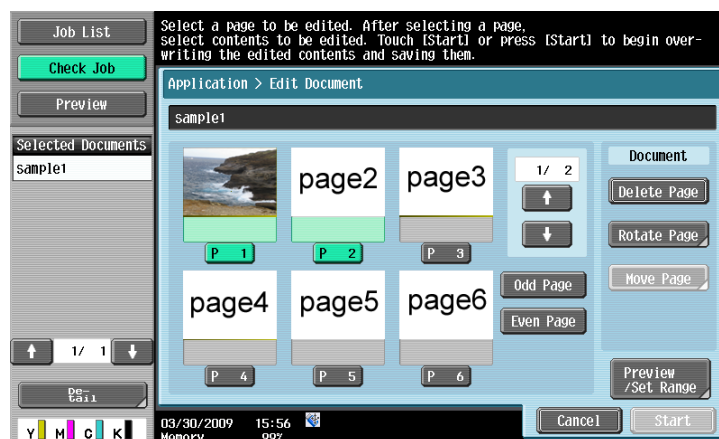

The preview images of the selected pages are displayed together with the rotation setting screen.

- 2 While checking the preview image, select the rotation angle.
 - You can select a rotation angle from left 90 degrees, right 90 degrees, and 180 degrees.
 - In this example, [Left 90°] is selected.

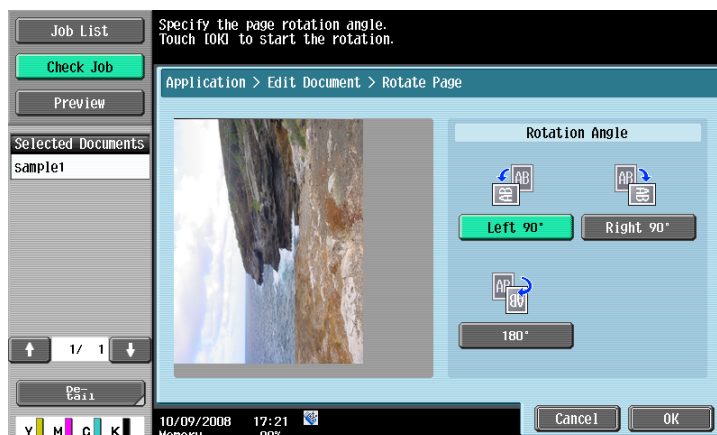

- 3 Press [OK].
- 4 If you are sure to rotate the selected pages, press [Start] or the **Start** key on the control panel.
 - In the example, the specified pages (pages 1 and 2) have been rotated.
 - At this time, the document data is not changed.

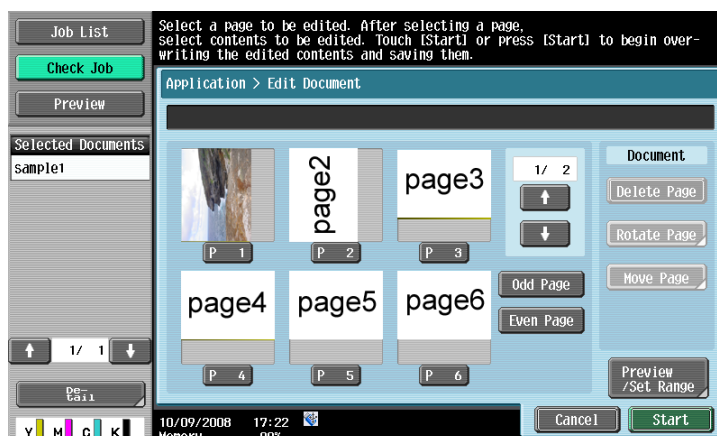

- 5 Check the information of the displayed screen. To rotate the pages, select [Save].
 - To cancel the rotation, press [Do Not Save] to return to the Edit Document screen.

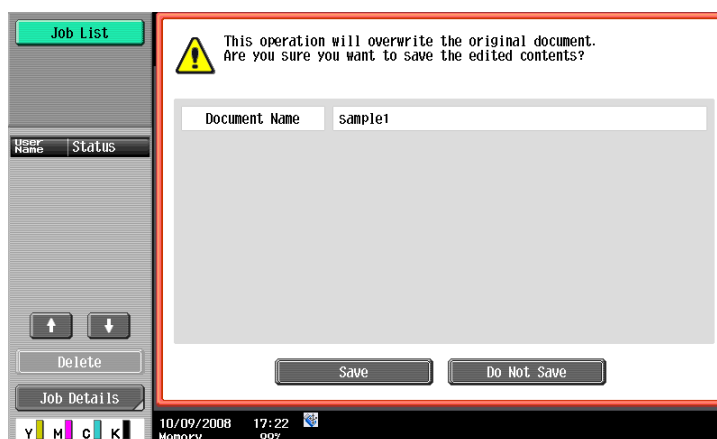

The selected pages are rotated and the document is saved.

Edit Document - Move Page

You can change the order of the pages within a saved document by moving the specified pages.

- ✓ You cannot rotate the only page of a document.
- ✓ You will be unable to restore the pages because they are overwritten when they are moved. If you will need the unchanged version of the document, make a backup copy of the document in advance. For details on how to copy a document, refer to page 7-67.
- ✓ You can directly enter the page number you want the selected page move to. This is useful when a document consists of many pages. For details, refer to page 7-77.

- 1 Select a page to be moved, and then press [Move Page].
 - Only one page can be moved at a time. To move two or more pages, repeat the above steps for each of the pages you want to move.
 - The example demonstrates how to move page 6 to between pages 2 and 3.

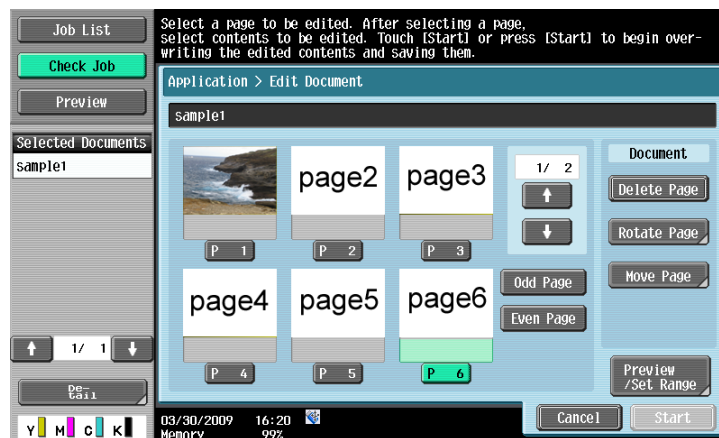

The destination setting screen is displayed.

- 2 While checking the screen, select the moving position.
 - To move the selected page to the beginning of the document, press [Top].
 - To move the selected page to the end of the document, press [Last Page].
 - To move the selected page to between pages, press  between them.

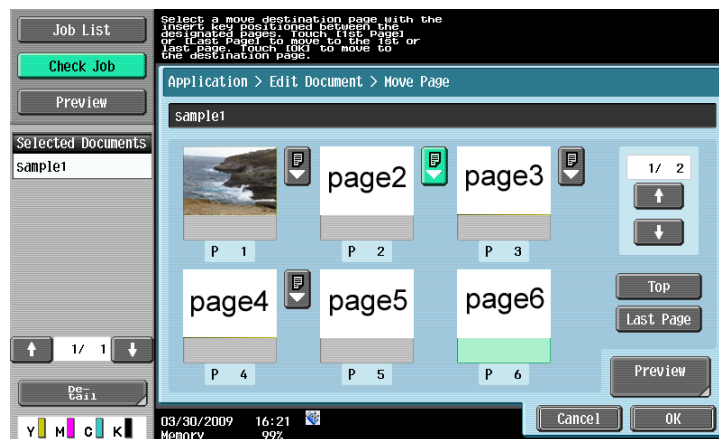

- 3 Press [OK].

- 4 If you are sure to move the selected page, press [Start] or the **Start** key on the control panel.
 → At this time, the document data is not changed.

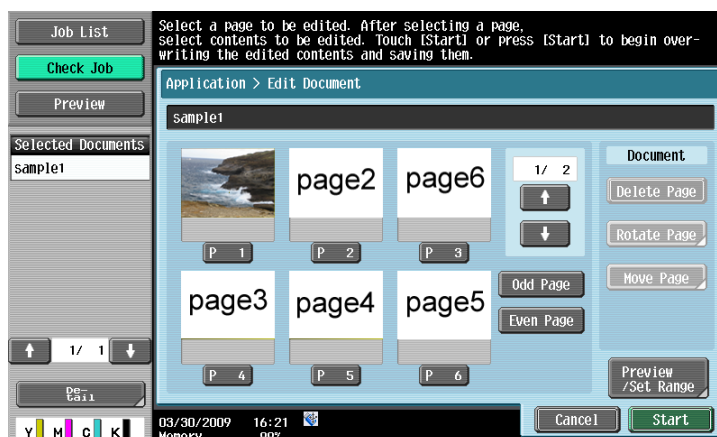

- 5 Check the information of the displayed screen. To move the page, select [Save].
 → To cancel the movement, press [Do Not Save] to return to the Edit Document screen.

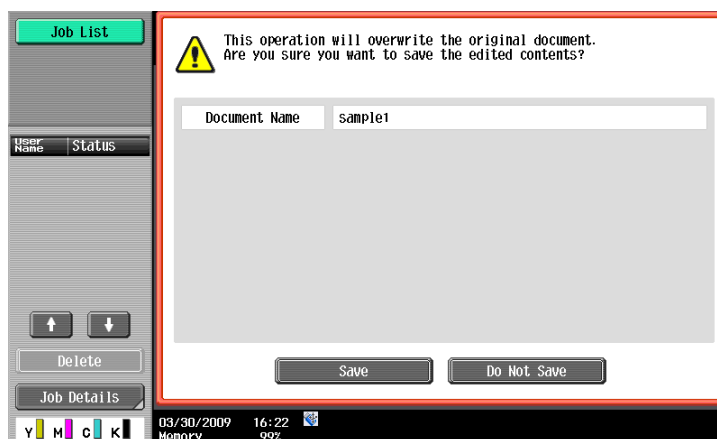

The selected page is moved and the document is saved.

Preview/Set Range

You can specify a range of pages and check preview images when the selected document consists of multiple pages. You can also change the display size.

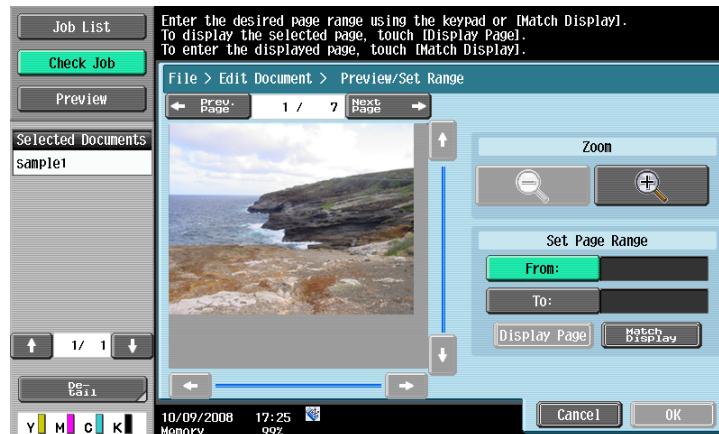

Item	Description
[← Prev. Page]	Moves to the previous page.
[Next Page →]	Press this button to move to the next page.
[Zoom]	You can view the image at full size or at a size of 2, 4 or 8 times the normal size. After you have changed the display size, use the scroll bars located in the right and the bottom of the image to view to the desired portion.
[Set Page Range]	Specify the range of pages to be checked. Use the keypad to enter a number in [From:] and [To:] respectively. Then press [Display Page] to preview the specified starting or ending page. To set [From:] or [To:] to the page being previewed, select the button and then press [Match Display].

Preview/Specify by Input

This item is displayed when [Move Page] is selected. When too many pages are saved, specify the destination page by entering the page number. The following shows a procedure to specify the destination of the move operation.

- 1 In the Move Page screen, press [Preview].
The Preview/Specify by Input screen is displayed.

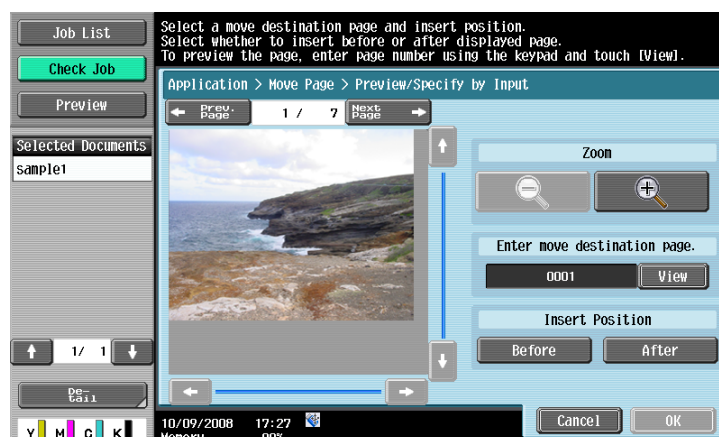

- 2 Display the previous or next page of the destination.
- Press [← Prev. Page] or [Next Page →], or use the keypad to enter a page number and press [View].
 - You can use [Zoom] to view the selected pages at full size or at a size of 2, 4 or 8 times the normal size. After you have changed the display size, use the scroll bars located in the right and the bottom of the image to view to the desired portion.



- 3 Specify the insertion position.
- To move before the displayed page, press [Before].
 - To move after the displayed page, press [After].



- 4 Press [OK].

7.8.3 Register Overlay

Register a document saved in a User Box as an overlay image. You can overlay the selected image to a printed document using [Stamp/Composition] in the Print tab. This function is useful when you want to print the images (such as company or product logos) that are not provided by this machine (stamps and page numbers are those provided by this machine).

Reference

- You can register up to 100 overlay images.
- When you select a multi-page document, the first page is registered as an overlay image.

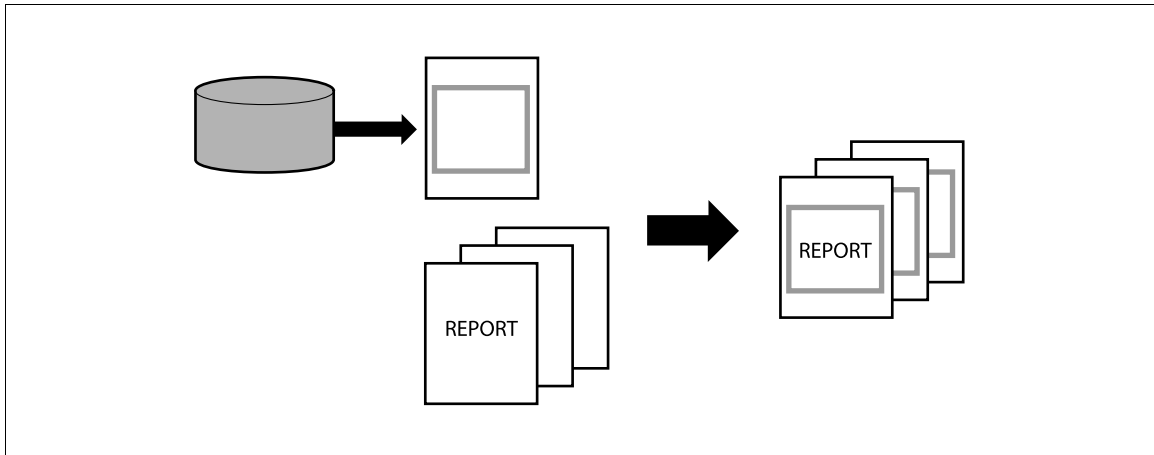

Register Overlay - New

Register a new overlay image.

- 1 Select a document and press [Register Overlay].



- 2 Press an unregistered image button and press [New].

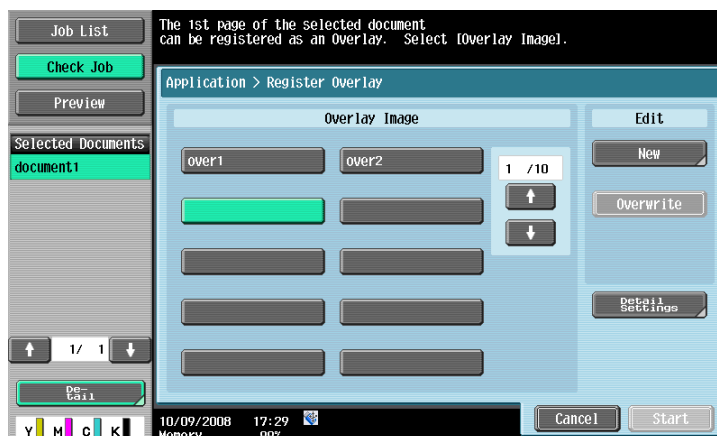

- 3 Enter the name of the overlay image to be registered, and press [OK].
→ You can enter up to 16 characters.
- 4 Press [Start].

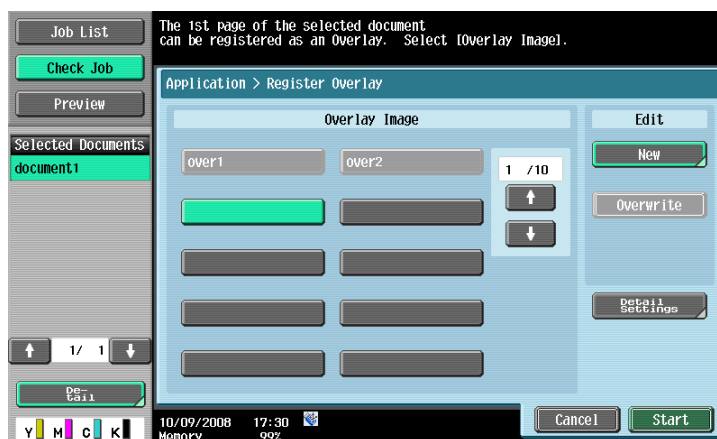

Register Overlay - Overwrite

You can overwrite the registered overlay image with new one.

- 1 Select a document and press [Register Overlay].

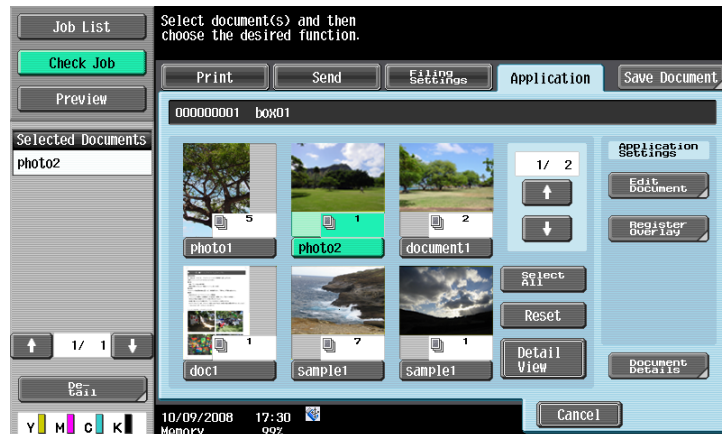

- 2 Press the image button to be overwritten, and press [Overwrite].

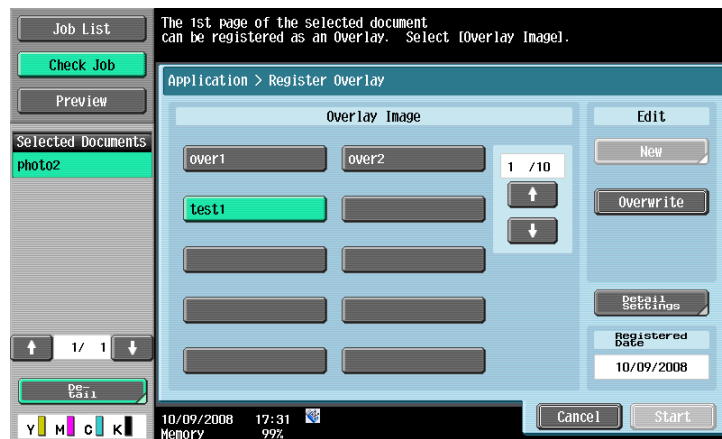

- 3 Check the displayed message, and press [Overwrite].

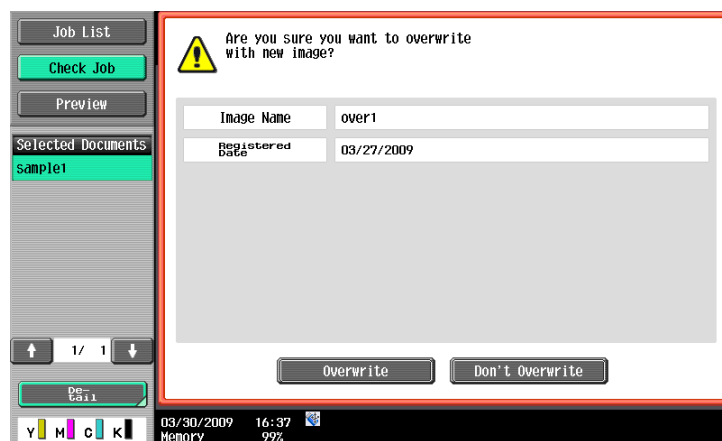

- 4 Press [Start].
The overlay image is overwritten.

Detail Settings

Configure the density or color of the newly registered or overwritten overlay image.

- Select the button of a target overlay image, and press [Detail Settings]. After configuring settings, press [OK].

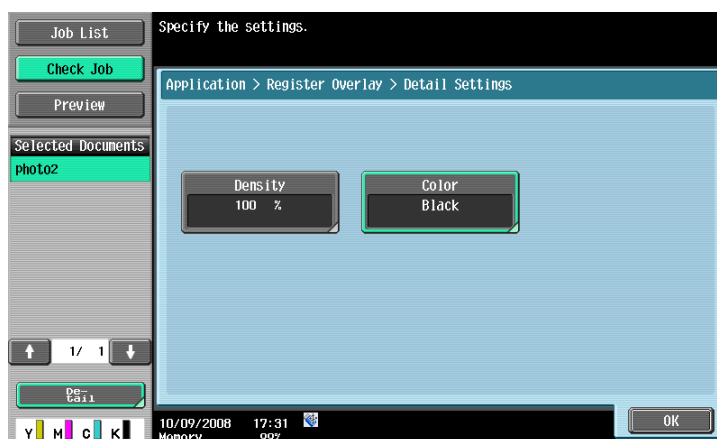

Item	Description
[Density]	Specify the density of the image. Use the keypad to enter the density using a value between 20 and 100%.
[Color]	Specify the color of the overlay image. [Full Color]: Prints a document in full color. [Black]: Prints a document in black and white.

7.9 Bulletin Board User Box (System User Box)

7.9.1 Overview of the Bulletin Board User Boxes

The Bulletin Board User Box is used to register a browsing document. A document registered in the Bulletin Board User Box is sent by the polling transmission function when a polling request is issued from the remote machine.

7.9.2 Bulletin Board User Box screen

Select the [Bulletin Board User Box] in the [System] tab to display registered Bulletin Board User Boxes. Select the Bulletin Board User Box that contains the document registered in this machine.

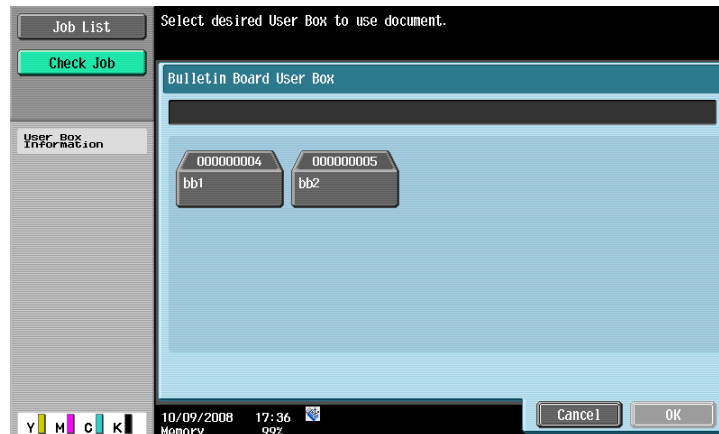

7.9.3 Printing a document in a Bulletin Board User Box

You can print a document saved in the Bulletin Board User Box. Check the preview or information of the document, press [Start] or the **Start** key on the control panel.

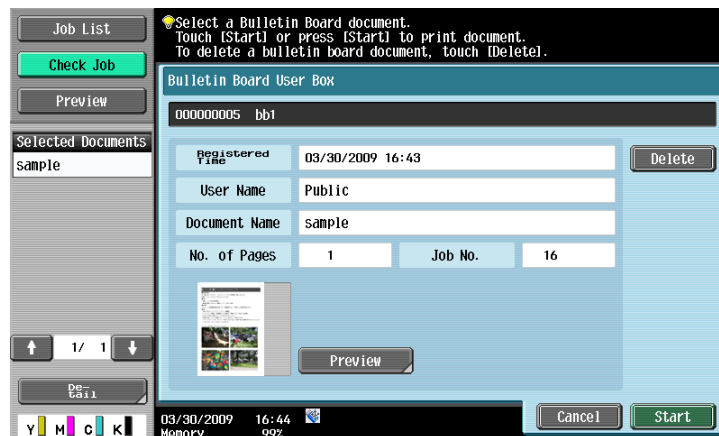

7.9.4 Deleting a document in the Bulletin Board User Box

You can save only one document in one Bulletin Board User Box. To register a new document in the Bulletin Board User Box, delete the existing document, and send a new document to the Bulletin Board User Box. To delete the document saved in the Bulletin Board User Box, check its registration time or source, and press [Delete].

7.10 Polling TX User Box (System User Box)

7.10.1 Overview of the Polling Transmission User Boxes

The Polling TX User Box is used to save a document to be sent in response to a request from a receiver. The process of saving a specific document in the Polling TX User Box is called polling transmission.

7.10.2 Printing a document in the Polling TX User Box

You can print a document saved in the Polling TX User Box. Check the preview or information of the document, press [Start] or the **Start** key on the control panel.

Reference

- You can register a document in the Polling TX User Box as an overlay image. For details on how to register an overlay image, refer to page 7-80.

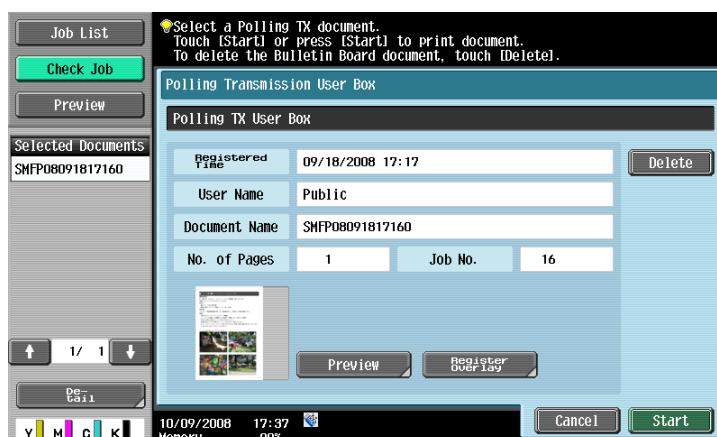

7.10.3 Deleting a document in the Polling TX User Box

You can save only one document in the Polling TX User Box. To register a new document in the Polling TX User Box, delete the existing document, and perform polling transmission of a new document. To delete the document saved in the Polling TX User Box, check its registration time or source, and press [Delete].



Reference

For details on the polling transmission procedure, refer to the [User's Guide Network Scan/Fax/Network Fax Operations].

7.11 Secure Document User Box (System User Box)

7.11.1 Overview of the Secure Document User Box

The Secure Document User Box is used to save a document that was printed with the specified ID and password. To print a document, you must enter the ID and password. The authentication procedure varies depending on the Prohibited Functions When Authentication Error setting in Administrator Settings - [Security Settings] - [Security Details]. For details, contact the administrator of this machine.



Reference

For details on how to save a secure document, refer to the [User's Guide Print Operations].

7.11.2 Authentication procedure 1

Follow the procedure below when Prohibited Functions When Authentication Error is set to [Mode 1] in [Security Settings] - [Security Details] of Administrator Settings.

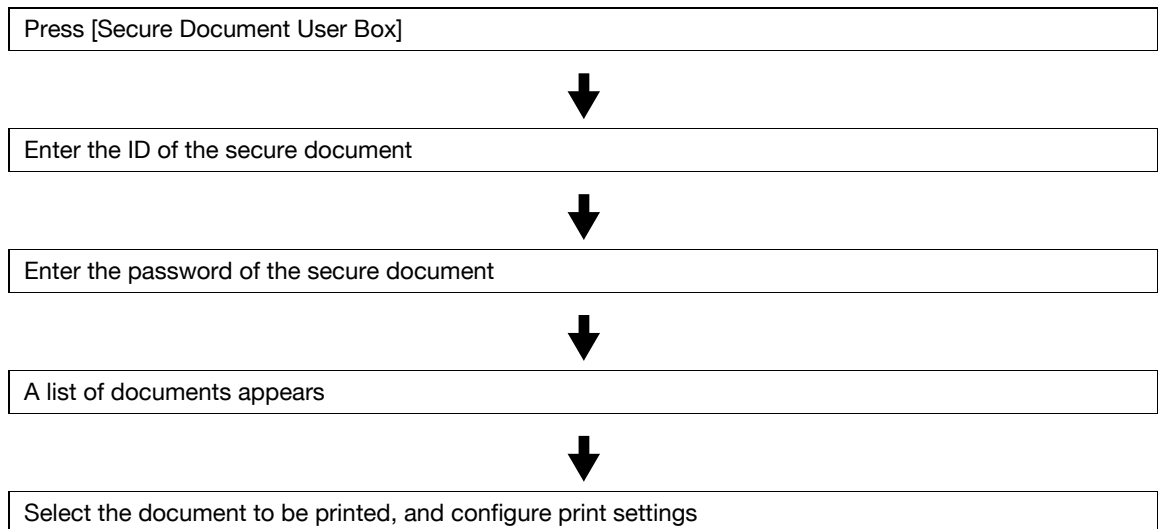

7.11.3 Authentication procedure 2

Follow the procedure below when Prohibited Functions When Authentication Error is set to [Mode 2] in [Security Settings] - [Security Details] of Administrator Settings.

Reference

- If [Mode 2] is selected, enter the password for each document even when the ID is the same. This is because you need to select the document first before entering the password. Therefore, the security level in this mode is higher than mode 1.

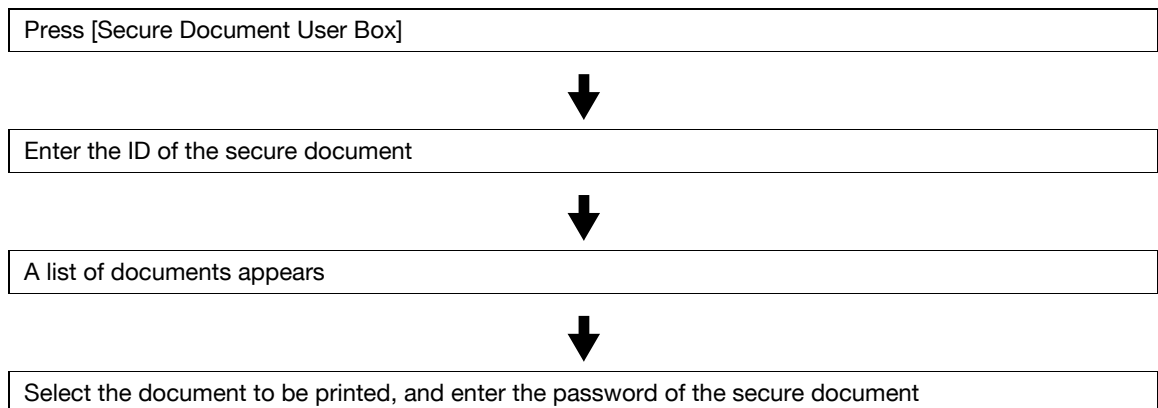

7.11.4 Print - Printing

You can add some functions to a document saved in the Secure Document User Box when printing the document.

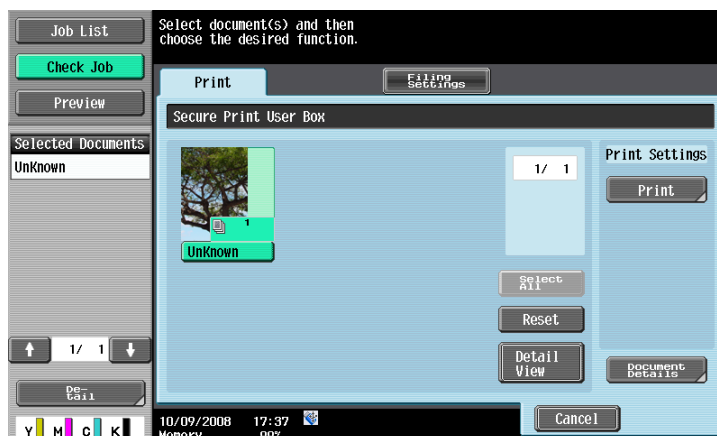

Copies

Use the keypad to enter the number of copies. A number between 1 and 9999 can be specified.

Print

Select 1-Sided or 2-Sided.

Color

For the setting procedure, refer to page 7-10.

Finishing

For the setting procedure, refer to page 7-10.

Combine

For the setting procedure, refer to page 7-14.

Zoom

For the setting procedure, refer to page 7-15.

Page Margin

For the setting procedure, refer to page 7-17.

Sheet/Cover/Chapter Insert

For the setting procedure, refer to page 7-18.

Stamp/Composition

For the setting procedure, refer to page 7-22.

7.11.5 Filing Settings

You can handle a document saved in the Secure Document User Box.

Reference

- To delete all documents in the Secure Document User Box at a time, select [User Box Settings] - [Delete Secure Print Documents] in Administrator Settings. For details, refer to page 8-20.

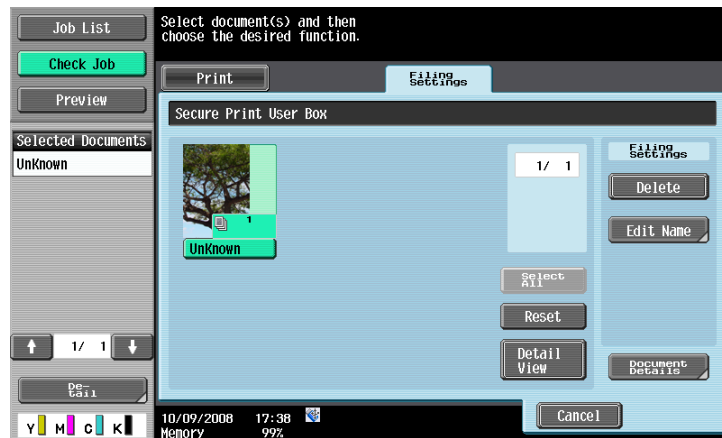

The available setting items are as follows.

Item	Description
[Delete]	Deletes an unnecessary document such as a document that you have printed.
[Edit Name]	Renames a saved document.
[Document Details]	Enables you to check the date and time a document has been saved as well as a preview image.

7.12 Memory RX User Box (System User Box)

7.12.1 Overview of the Memory RX User Box

The Memory RX User Box is used to save a received document in the memory and print it as required. When memory reception is enabled, a received document is automatically saved in the Memory RX User Box. To check a document saved in the Memory RX User Box, select [Compulsory Memory RX User Box] in the [System User Box] tab, and then enter the password that was specified when memory reception was enabled.



Reference

For details on how to specify the password for memory reception settings, refer to the [User's Guide Network Scan/Fax/Network Fax Operations].

7.12.2 Print

Select a document to be printed, and press [Print]. After the specified document has been printed, data is deleted automatically.



7.12.3 Filing Settings

You can handle a document saved in the Memory RX User Box.

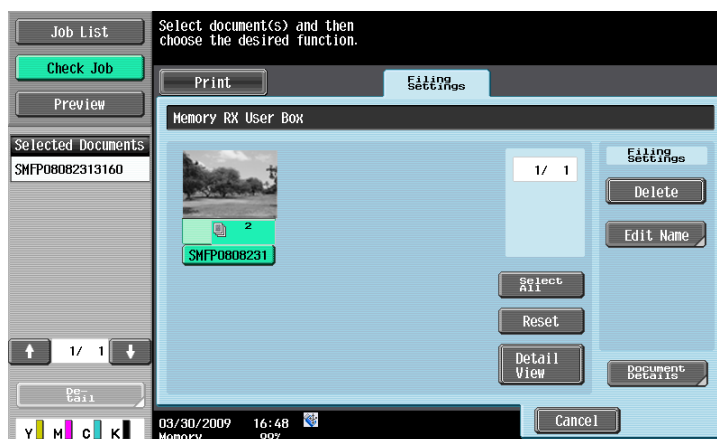

The available setting items are as follows.

Item	Description
[Delete]	Deletes a document that does not need to be printed.
[Edit Name]	Renames a saved document.
[Document Details]	Enables you to check the date and time a document has been saved as well as a preview image.

7.13 Annotation User Box (System User Box)

7.13.1 Overview of the Annotation User Box

Annotation User Boxes are used to automatically assign a number to a saved documents and add the number when printing or sending the document. You can pre-register the number to be assigned when creating the User Box and change it when printing or sending documents. For the functions you can configure when printing or sending documents, refer to page 7-9 and the sections that follow. Select [Annotation User Box] in the [System User Box] tab, and press [Use/File]. The registered Annotation User Boxes are displayed.

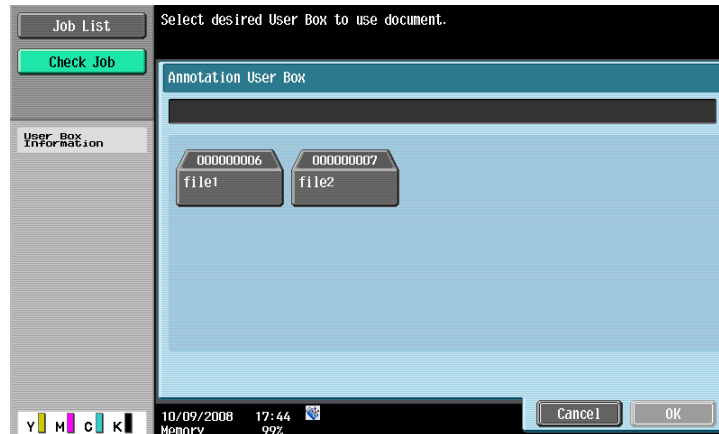

Reference

- Go to Administrator Settings to register the Annotation User Box. For details, refer to page 8-17.
- For the types of numbers that can be printed in Annotation User Boxes, refer to page 7-92.
- To print the numbers specified in the Annotation User Box without saving a document in the User Box, set Auto Document Delete Time to [Do Not Keep]. This is useful for managing the numbers that are added to the copied documents. Specify the Auto Document Delete Time when you create an Annotation User Box. For details, refer to page 8-17.

If you open a User Box, you can configure print and transmission settings.



7.13.2 Print - Basic

For the setting procedure, refer to page 7-9.

7.13.3 Print - Page Margin

For the setting procedure, refer to page 7-17.

7.13.4 Print - Sheet/Cover/Chapter Insert - Cover Sheet

For the setting procedure, refer to page 7-19.

7.13.5 Print - Sheet/Cover/Chapter Insert - Insert Sheet

For the setting procedure, refer to page 7-20.

7.13.6 Print - Sheet/Cover/Chapter Insert - Chapters

For the setting procedure, refer to page 7-21.

7.13.7 Print - Stamp/Composition - Date/Time

For the setting procedure, refer to page 7-22.

7.13.8 Print - Stamp/Composition - Page Number

For the setting procedure, refer to page 7-23.

7.13.9 Print - Stamp/Composition - Stamp

For the setting procedure, refer to page 7-24.

7.13.10 Print - Stamp/Composition - Copy Security - Copy Protect

For the setting procedure, refer to page 7-25.

7.13.11 Print - Stamp/Composition - Copy Security - Copy Guard

For the setting procedure, refer to page 7-27.

7.13.12 Print - Stamp/Composition - Copy Security - Password Copy

For the setting procedure, refer to page 7-28.

7.13.13 Print - Stamp/Composition - Stamp Repeat

For the setting procedure, refer to page 7-30.

7.13.14 Print - Stamp/Composition - Registered Overlay

For the setting procedure, refer to page 7-33.

7.13.15 Description of the Send tab

For the setting procedure, refer to page 7-35.

7.13.16 Send - Address Book - Search

For the setting procedure, refer to page 7-39.

7.13.17 Send - Direct Input - E-mail

For the setting procedure, refer to page 7-42.

7.13.18 Send - Direct Input - PC (SMB)

For the setting procedure, refer to page 7-44.

7.13.19 Send - Direct Input - FTP

For the setting procedure, refer to page 7-45.

7.13.20 Send - Direct Input - WebDAV

For the setting procedure, refer to page 7-46.

7.13.21 Send - Job History

For the setting procedure, refer to page 7-47.

7.13.22 Send - LDAP Search - Search

For the setting procedure, refer to page 7-48.

7.13.23 Send - LDAP Search - Advanced Search

For the setting procedure, refer to page 7-48.

7.13.24 Send - Document Settings - Resolution

For the setting procedure, refer to page 7-49.

7.13.25 Send - Document Settings - File Type

For the setting procedure, refer to page 7-50.

7.13.26 Send - Document Settings - Color

For the setting procedure, refer to page 7-54.

7.13.27 Send - Communication Settings - E-mail Settings

For the setting procedure, refer to page 7-57.

7.13.28 Send - Communication Settings - URL Notification Setting

For the setting procedure, refer to page 7-59.

7.13.29 Send - Communication Settings - E-mail Encryption

For the setting procedure, refer to page 7-62.

7.13.30 Send - Communication Settings - Digital Signature

For the setting procedure, refer to page 7-62.

7.13.31 Send - Application - Stamp/Composition - Date/Time

For the setting procedure, refer to page 7-63.

7.13.32 Send - Application - Stamp/Composition - Page Number

For the setting procedure, refer to page 7-63.

7.13.33 Send - Application - Stamp/Composition - Stamp

For the setting procedure, refer to page 7-63.

7.13.34 Send - Application - Send & Print

For the setting procedure, refer to page 7-64.

7.13.35 Send - Application - Stamp Element

Secondary Field

Add text to a number to be printed. You can enter up to 20 characters.

Date/Time

Select the format for the date and time to be printed.

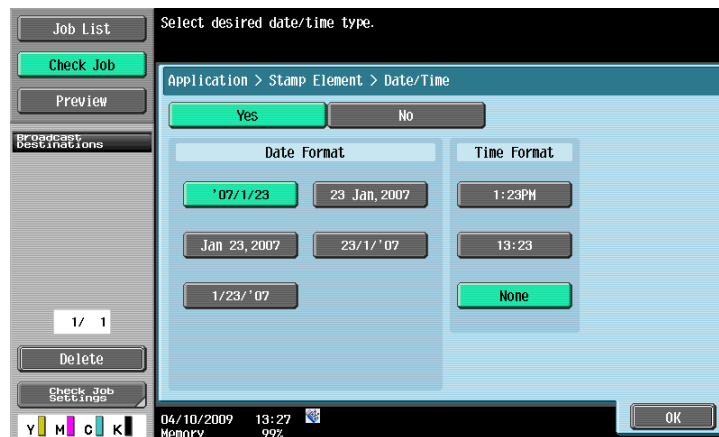

Density

Select the density for the annotation numbers to be printed.

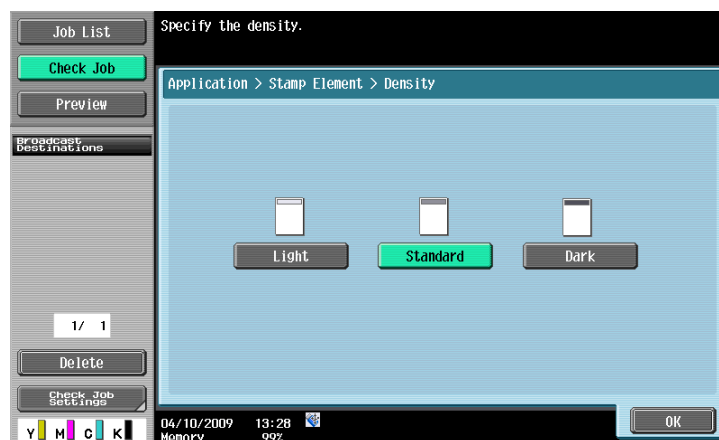

Number Type

Select the output format (number of digits) for the annotation numbers to be printed.

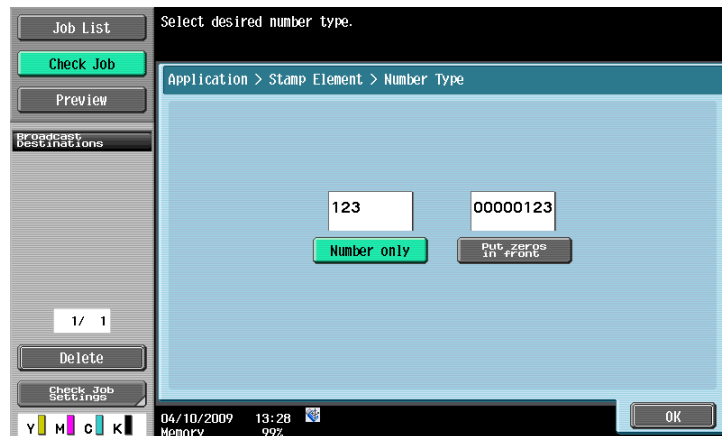

Print Position

Select the printing position.

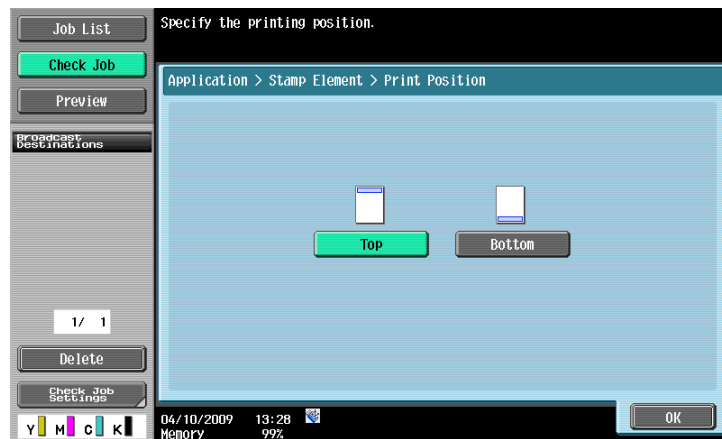

7.13.36 Filing Settings

You can handle a document saved in an Annotation User Box.

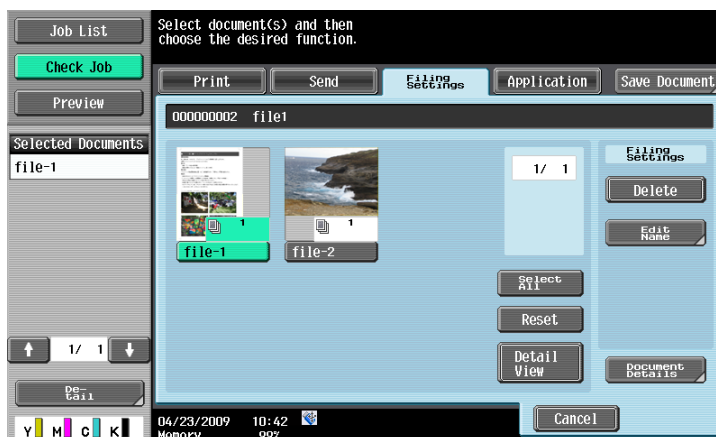

The available setting items are as follows.

Item	Description
[Delete]	Deletes an unnecessary document such as a document that you have printed.
[Edit Name]	Renames a saved document.
[Document Details]	Enables you to check the date and time a document has been saved as well as a preview image.

7.13.37 Application - Register Overlay

For the setting procedure, refer to page 7-79.

7.14 Fax Retransmit User Box (System User Box)

7.14.1 Overview of the Fax Retransmit User Box

The Fax Retransmit User Box is used to save a document, which was unable to be sent after the number of redials reached the value specified in Line Parameter Settings because the remote machine was busy when sending the fax for a predetermined time period. With this User Box, you can print for conformation or resend a saved document later. Select [Fax Retransmit User Box] in the [System User Box] tab, and press [Use/File]. A list of saved documents are displayed.

Reference

- Before you can save a document in the Fax Retransmit User Box, you must enable the Fax Retransmit User Box in the [Fax Settings] of Administrator Settings. For details on settings, refer to the [User's Guide Network Scan/Fax/Network Fax Operations].

7.14.2 Print - Proof Print

Before retransmitting a saved document, you can print the document for conformation. Data is not deleted after being printed. Select a document to be printed, and press [Proof Print]. Check document information, and press [Start].

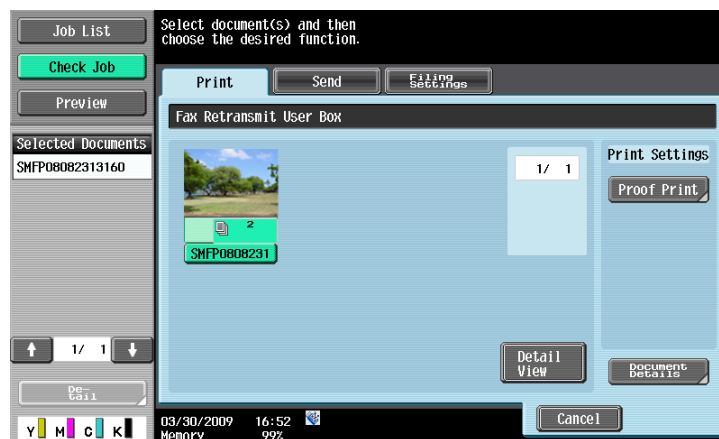

7.14.3 Send - Fax

Retransmit a saved document. Select a document, select the [Send] tab, and press [Fax].

Reference

- You can specify a new destination when retransmitting a document. You can specify the new destination in Address Book, Direct Input, or Job History.
- You can configure transmission settings when you retransmit a saved document. You can also configure line and fax header settings. For details, refer to page 7-55 and page 7-62.
- After document sending has been completed, data is deleted automatically.



7.14.4 Filing Settings - Delete

Stop retransmission and delete the target document. Select a document, select the [Filing Settings] tab, and press [Delete].



7.15 Password Encrypted PDF User Box (System User Box)

7.15.1 Overview of the Password Encrypted PDF User Box

When you use **PageScope Web Connection** or **PageScope Direct Print** to print a PDF file that has been saved with a password configured, or you print an encrypt PDF data that has been saved in the external memory, the data is automatically saved in the Password Encrypted PDF User Box. Select [Password Encrypted PDF User Box] in the [System User Box] tab, and press [Use/File]. A list of saved documents are displayed.

Reference

- Only password encrypted PDF data saved by the user who is logged in is displayed when User Authentication is enabled in this machine.

7.15.2 Print/Save –Print/Save

Select a document to be printed or saved, and press [Print/Save]. When printing or saving a document, enter the password assigned to the PDF file. After printing or saving has been completed, documents in the Password Encrypted PDF User Box are deleted automatically.

Reference

- Whether to print or save is specified in the direct print instruction issued from your computer. You cannot change a print instruction to a save instruction or vice versa.

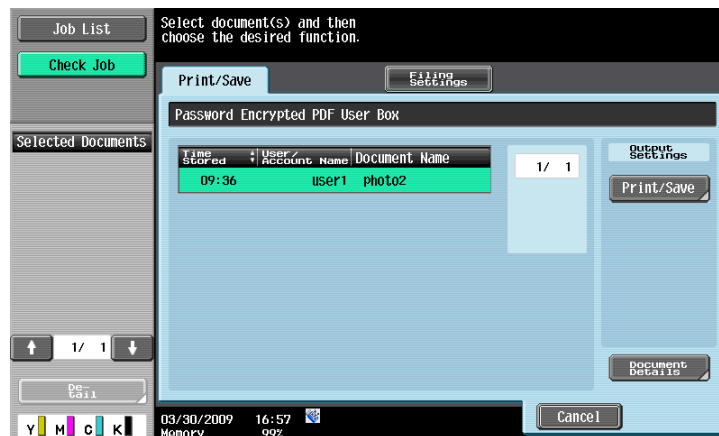

7.15.3 Filing Settings - Delete

You can delete a saved document if it does not need to be printed. Select a document to be deleted, and press [Delete].

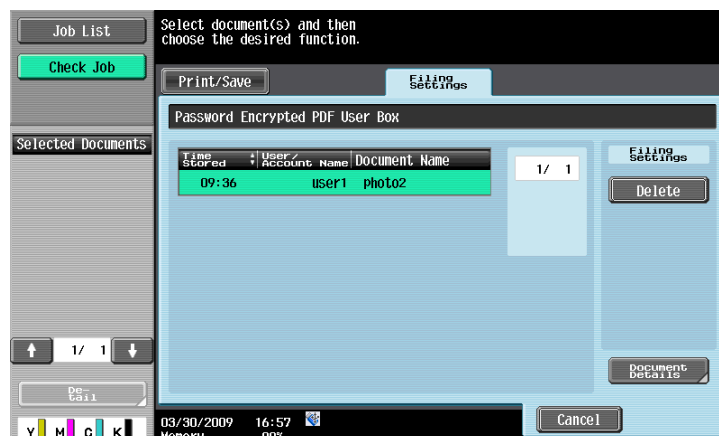

7.16 ID & Print User Box (System User Box)

7.16.1 Overview of the ID & Print User Box

Viewing documents

This item appears when user authentication settings are configured. A document saved in this User Box can be printed by the user of the document when the user is logged in to the machine. When you print a document from a computer over the network to this machine by entering the user name and password, the document is temporarily saved in the ID & Print User Box.

→ Select [ID & Print User Box] in the [System User Box] tab, and press [Use/File]. A list of saved documents are displayed.

Reference

- When there are documents saved in the ID & Print User Box, the following buttons are displayed in the login screen. Enter the user name and password, and press the desired button.
- [Begin Printing]: Press this button to print documents saved in the ID & Print User Box without logging in to this machine.
- [Print & Login]: Press this button to login to this machine and print the documents saved in the ID & Print User Box.
- [Login]: Press this button to log in to this machine but not print the documents. After you are logged in, you can print or delete documents saved in the ID & Print User Box.
- Documents can be saved in the ID & Print User Box even when user authentication is not enabled. In addition, jobs saved by public users can be saved in the ID & Print User Box. For details, refer to page 8-25.
- After printing documents has been completed, the data in the ID & Print User Box is deleted automatically. A confirmation screen for confirming if you are sure to delete the data appears depending on the settings in Administrator Settings.



Reference

For details on how to print a document from a computer to the ID & Print User Box, refer to the [User's Guide Print Operations].

7.16.2 Print - Print

- 1 Select a document to be printed, and press [Print].

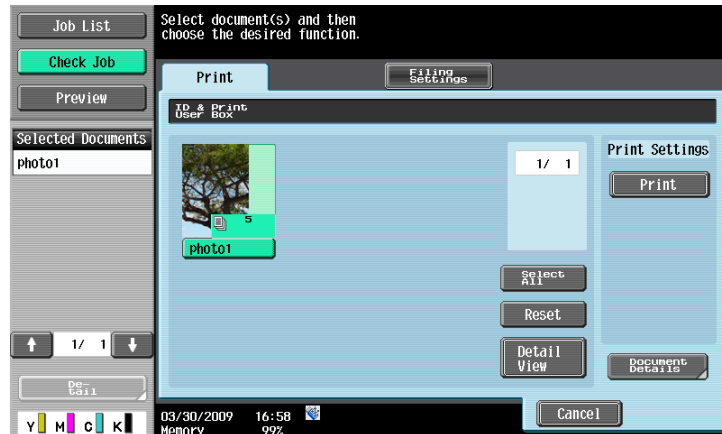

- 2 Select whether to delete the document after printing.

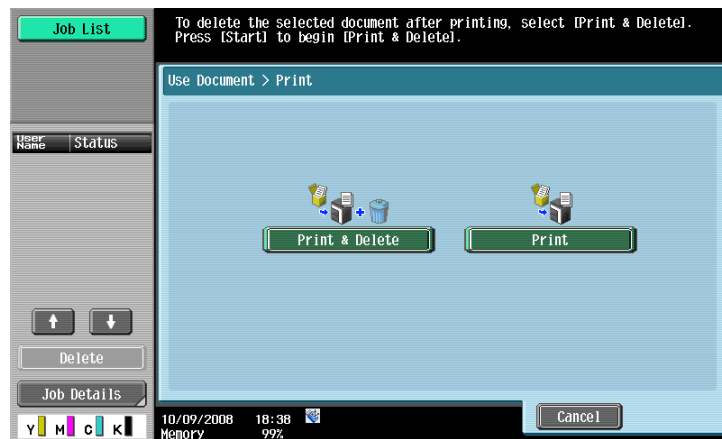

7.16.3 Filing Settings - Delete

Select a document to be deleted, and press [Delete].

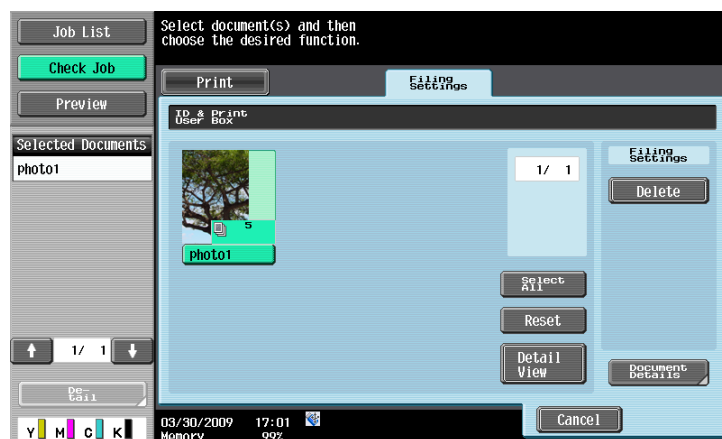

7.17 External Memory (System User Box)

7.17.1 External memory device

Supported external memory devices

Requirements for external memory devices of this machine are as follows.

- USB flash memory device that supports the USB (1.1/2.0) interface
- FAT32-formatted memory device

Connecting the external memory device

- ✓ Use the USB connector on the side that is near the control panel. Do not use the USB connector near the rear side because it is used for optional devices.
 - ✓ Do not disconnect the external memory device while saving a document in the external memory device or printing a document saved in the external memory device.
 - ✓ Do not use the USB device (hard disk or USB hub) other than the USB flash memory device.
 - ✓ Do not connect or disconnect the USB memory when the hourglass is being displayed in the control panel while this machine is active.
 - ✓ Do not disconnect the USB memory just after connecting it.
- ➔ Connect the external memory device to the USB connector on the side of this machine.

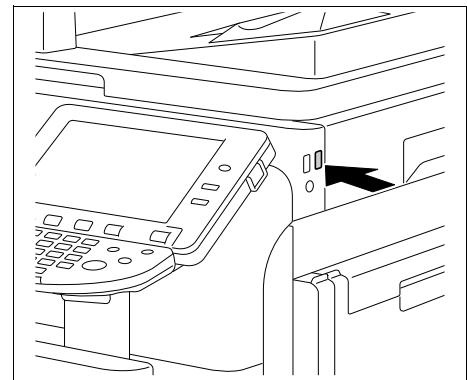

When the external memory device is connected, an icon appears at the bottom of the screen and the following screen is displayed. If you will immediately use the external memory, select the intended purpose. When not using the external memory, select [Close].

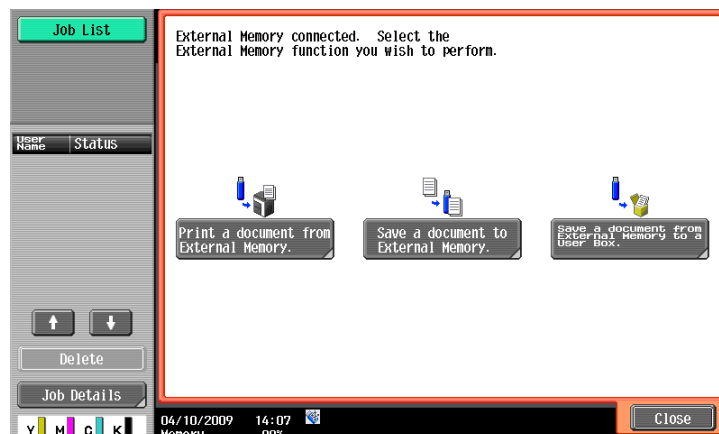

Reference

- The intended purpose of the external memory to be displayed varies depending on the administrator settings.

7.17.2 External memory screen

When the external memory device is connected, select [External Memory] to display the folder structure.



Entering a file path

In the touch panel, you can specify the file path to the folder containing the document to be printed. Press [File Path], and enter the file path.

Reference

- Make sure that the total length of the file path and file name do not exceed 250 characters. If the number of characters exceeds the limit, the file list is not displayed.

Selecting a file

You can print the following file types: PDF, JPEG, TIFF, and XPS. Select a document of one of these types from the list.

Reference

- 2-sided printing, punching, or stapling are not supported for JPEG and XPS files.
- Printing is not possible when printing is restricted by Security Settings of a PDF file.
- This machine supports printing of PDF Version 1.6 or earlier.
- Only the files of printable file types are displayed in the list.
- File access fails when the total length of the file path and file name exceeds 250 characters.
- Up to 200 printable files are displayed in the folder of the specified file path. If the folder contains 201 or more files, it may take time to display the file list screen.

Printing encrypted PDF data

To print the encrypted PDF data saved in the external memory device, select the data in the External Memory screen and print the data. When the print command is issued, the encrypted PDF data in the external memory is saved in the Password Encrypted PDF User Box of this machine. Access the Password Encrypted PDF User Box of this machine, and then print the data.



Reference

For the Password Encrypted PDF User Box, refer to page 7-97.

Moving to the parent folder

To move to the parent folder, press [Up].

Opening a folder

To check the contents of a specific folder, press [Open].

Print

Select a document to be printed, and press [Print]. The Print Details screen is displayed.

Document Details

You can check the modification date, file name, and other properties of the selected document.

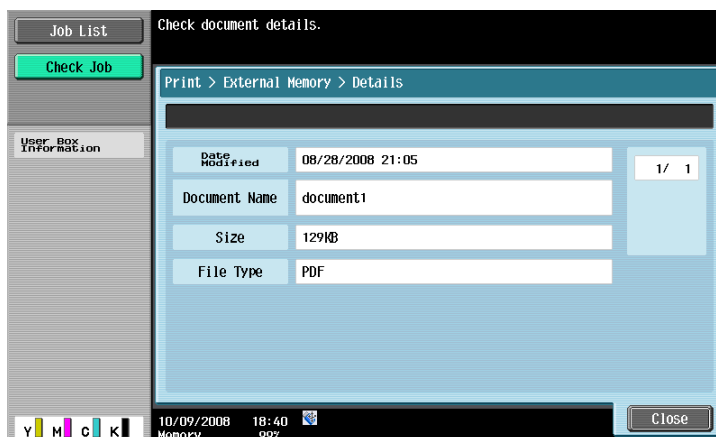

7.17.3 Print - Basic

Press [Print] to display the following screen.

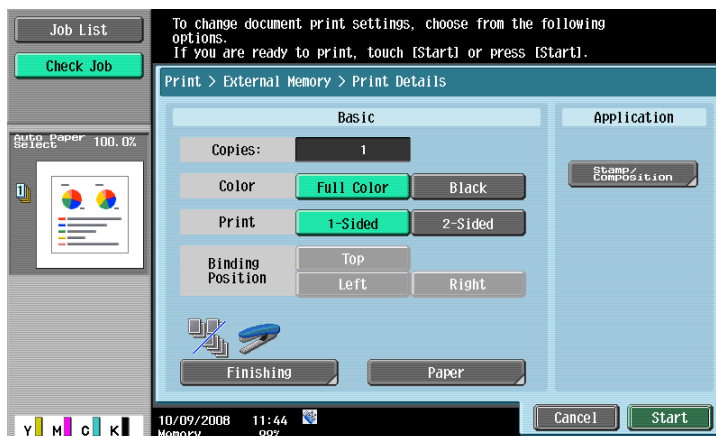

Copies

Use the keypad to enter the number of copies. A number between 1 and 9999 can be specified.

Color

Specify whether to print the document in color or black and white.

Print

Select 1-Sided or 2-Sided.

Binding Position

When you select 2-Sided in [Print], select the binding position.

Finishing

For the setting procedure, refer to page 7-10.

Reference

- 2-sided printing, punching, or stapling are not supported for JPEG and XPS files.

Paper

Select a tray to load printing paper.

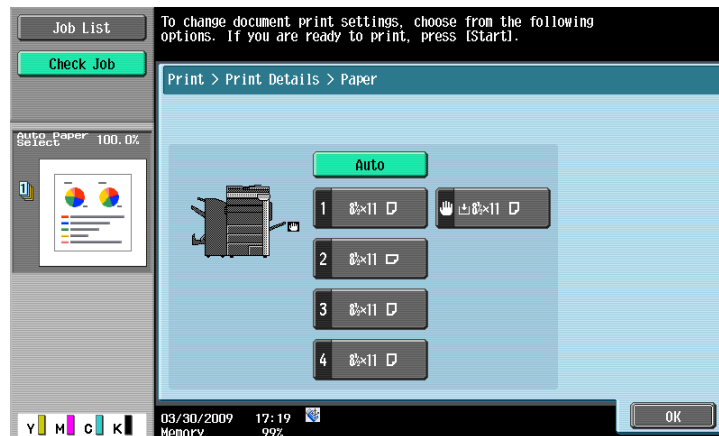

7.17.4 Print- Application

Stamp/Composition - Date/Time

For the setting procedure, refer to page 7-22.

Stamp/Composition - Page Number

For the setting procedure, refer to page 7-23.

Stamp/Composition - Stamp

For the setting procedure, refer to page 7-24.

Stamp/Composition - Copy Security - Copy Protect

For the setting procedure, refer to page 7-25.

Stamp/Composition - Copy Security - Copy Guard

For the setting procedure, refer to page 7-27.

Stamp/Composition - Copy Security - Password Copy

For the setting procedure, refer to page 7-28.

Stamp/Composition - Stamp Repeat

For the setting procedure, refer to page 7-30.

7.17.5 Filing Settings—Save in User Box

This function saves a document stored in the external memory in a User Box. Specify the User Box and document name, and press [Start] or the **Start** key on the control panel.

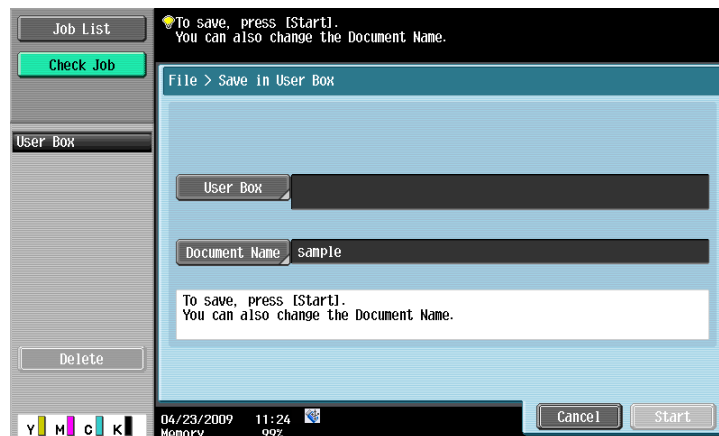

Item	Description
[User Box]	Select the Public, Personal, or Group User Box to save data in.
[Document Name]	Specify the name of the document to be saved. <ul style="list-style-type: none"> If you select multiple files, you cannot specify the document name.

7.18 Mobile/PDA (System User Box)

This function enables you to print a document stored in a cellular phone or PDA via a Bluetooth communication or to save such a document in a User Box.

7.18.1 Operating environment

The cellular phones and PDAs that can be connected to this machine and the printable file must satisfy the following conditions.

Operating environment

Communication protocol	Bluetooth Ver. 2.0 + EDR
Supporting profile	OPP/BPP/SPP/BIP/HCRP
Supporting file type	PDF/CPDF/XPS/CXPS/TIFF/JPEG/XHTML/RepliGo <ul style="list-style-type: none"> • For XHTML file types, the machine supports the character code of UTF-8/Shift-JIS/ISO-8859 and the link file extensions of JPEG/JPG/PNG. • This machine supports RepliGo version 2.1.0.9.

Reference

- To print documents from a cellular phone or PDA, the optional **Local Interface Kit EK-605** is required. The settings for enabling a Bluetooth communication are also required. Contact your service representative in advance.
- If you cannot access the link file when attempting to print an XHTML file, the document will either not be printed or will be printed in a black frame depending on the setting in [User Settings] - [Cellular Phone/PDA Setting] - [Link File Error Notification].
- To access the link file for printing an XHTML file, [WebDAV Settings] of this machine is required.
- To use a proxy for connection, register a proxy server in [Administrator Settings] - [Network Settings] - [WebDAV Settings] - [WebDAV Client Settings] - [Host Address], and set [User Settings] - [Cellular Phone/PDA Setting] - [Proxy Server Use] to [ON].
- The communication speed may drop or communication may be interrupted due to obstacles, signal quality, magnetic field or static electricity.
- Protected documents and image data may not be sent depending on the security setting of the cellular phone or PDA.

7.18.2 Mobile/PDA - Print List

Reference

- To save a file stored in a cellular phone or PDA in a User Box, or to print such a file, configure the appropriate setting in Administrator Settings in advance. For details, refer to page 8-25. To use a Bluetooth communication, the Bluetooth setting must be enabled in this machine. For details, refer to [User's Guide Network Administrator].
- When user authentication is specified on this machine, even a registered user cannot print a document unless printing from a cellular phone or PDA is allowed in the machine setting. For user authentication, contact the administrator of this machine.

Entering the PIN code

If you enter the 4-digit PIN code from a cellular phone or PDA, a connection is established, and data is sent to this machine to be printed.

Reference

- Check the PIN code in the instruction manual or in the setting instructions of the cellular phone or PDA.

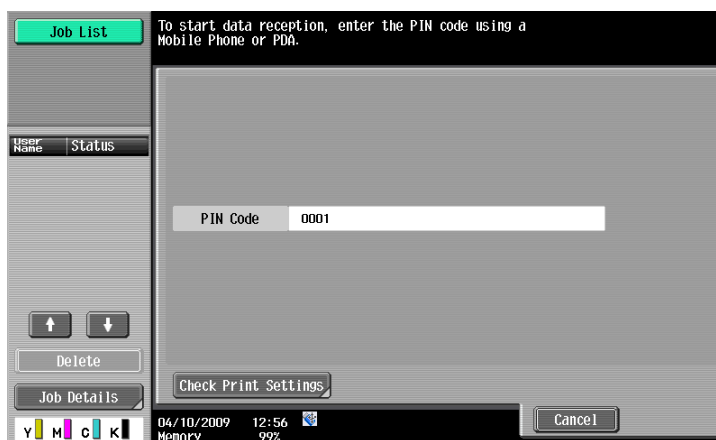

Check printing preferences

You can check the overview of the settings to print the received data.

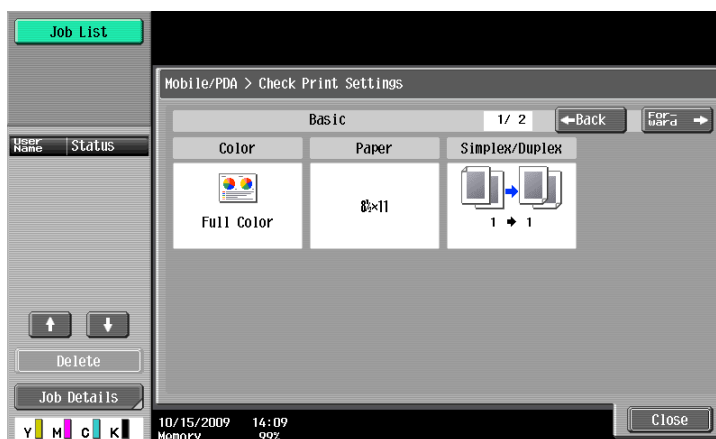

Reference

To configure print settings, select [Cellular Phone/PDA Setting] in the Utility menu. For details, refer to page 8-12.

7.18.3 Mobile/PDA - Save in User Box

Entering the PIN code

If you enter the 4-digit PIN code from a cellular phone or PDA, a connection is established, and data is sent to this machine to be saved in a User Box.

Reference

- Check the PIN code in the instruction manual or in the setting instructions of the cellular phone or PDA.

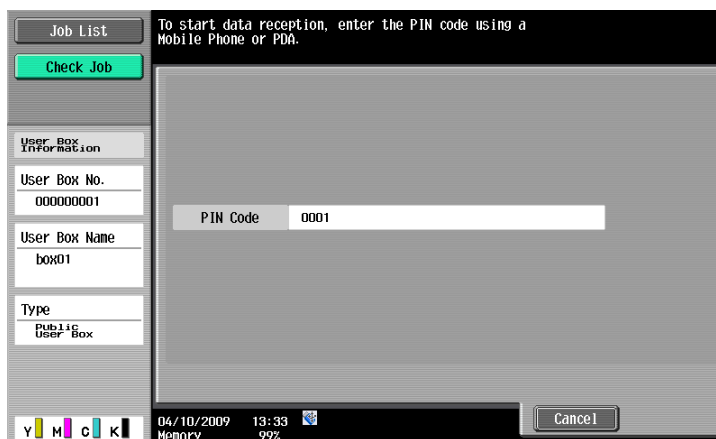

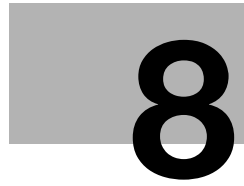

User Box Settings

8 User Box Settings

8.1 Menu tree of User Box Settings

The following shows the menus and items used to configure User Box settings in the Utility menu.

8.1.1 User mode

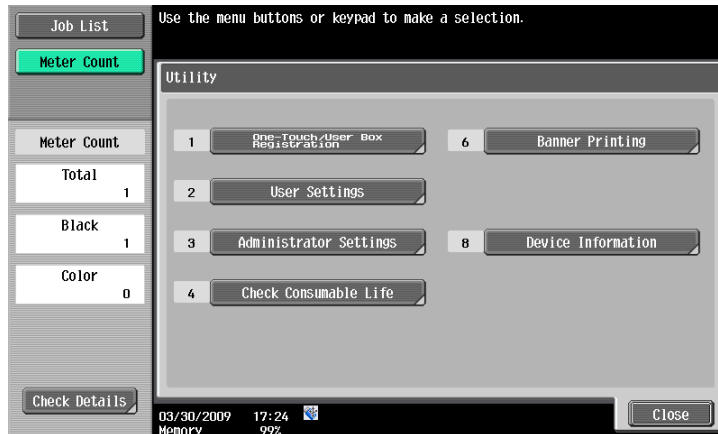

First level	Second level	Third level	Fourth level		
1 [One-Touch/User Box Registration] (p. 8-6)	2 [Create User Box] (p. 8-6)	1 [Public/Personal User Box] (p. 8-6)	[New]		
			[Edit]		
			[Delete]		
		2 [Bulletin Board User Box] (p. 8-7)	3 [Relay User Box] (p. 8-9)	[New]	
				[Edit]	
				[Delete]	
		2 [User Settings]	2 [Custom Display Settings]	3 [User Box Settings] (p. 8-10)	[Default Tab]
					[Shortcut Key 1]
					[Shortcut Key 2]
[Cellular Phone/PDA Setting]	[Link File Error Notification] (p. 8-11)		[Proxy Server Use] (p. 8-11)	[Print]	
				[Color]	
			[Print] (p. 8-12)	[Paper]	
				[Finishing]	
				[Page Margin]	
				[Stamp/Composition]	

8.1.2 Administrator Settings

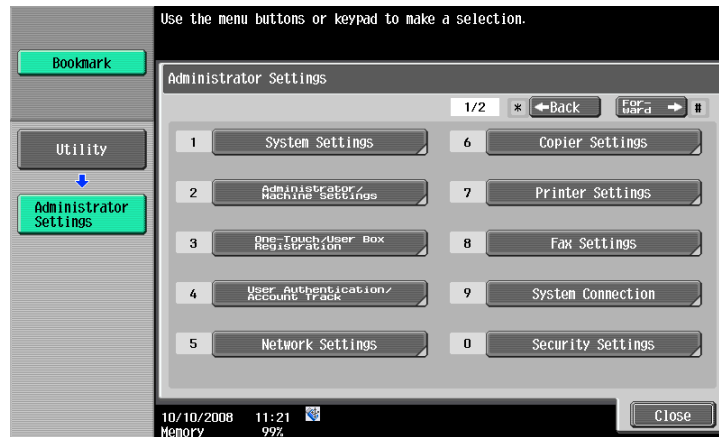

First level	Second level	Third level	Fourth level
1 [System Settings]	0 [User Box Settings] (p. 8-20)	1 [Delete Unused User Box] (p. 8-20)	
		2 [Delete Secure Print Documents] (p. 8-20)	
		3 [Auto Delete Secure Document] (p. 8-21)	
		4 [Encrypted PDF Delete Time] (p. 8-21)	
		5 [ID & Print Delete Time] (p. 8-22)	
		6 [Document Hold Setting] (p. 8-22)	
		7 [External Memory Function Settings] (p. 8-23)	[Save Document]
			[Print Document]
			[External Memory Document Scan]
			8 [Allow/Restrict User Box] (p. 8-23)
	9 [ID & Print Delete after Print Setting] (p. 8-24)		
	0 [Document Delete Time Setting] (p. 8-24)		

First level	Second level	Third level	Fourth level
3 [One-Touch/User Box Registration]	2 [Create User Box] (p. 8-16)	1 [Public/Personal User Box] (p. 8-6)	[New]
			[Edit]
			[Delete]
			[Delete Empty User Box(es)] (p. 8-7)
		2 [Bulletin Board User Box] (p. 8-7)	[New]
			[Edit]
			[Delete]
		3 [Relay User Box] (p. 8-9)	[New]
			[Edit]
			[Delete]
4 [Annotation User Box] (p. 8-17)	[New]		
	[Edit]		
	[Delete]		
4 [Maximum Number of User Boxes] (p. 8-19)	[Max. No. of Use Boxes]		
	[Maximum Number of User Boxes]		
4 [User Authentication/ Account Track]	2 [User Authentication Settings]	1 [Administrative Setting]	[ID & Print Settings] (p. 8-25)
9 [System Connection]	5 [Cellular Phone/PDA Setting] (p. 8-25)		
0 [Security Settings]	2 [User Box Administrator Setting] (p. 8-26)		
	4 [Security Details]	[Secure Print Only] (p. 8-27)	
	6 [HDD Settings]	1 [Check HDD Capacity] (p. 8-27)	
		2 [Overwrite HDD Data] (p. 8-28)	[Overwrite Method]
			[Encryption Priority]
			[Overwrite Priority]
		3 [Overwrite All Data] (p. 8-29)	
		4 [HDD Lock Password] (p. 8-30)	
		5 [Format HDD] (p. 8-31)	
		6 [HDD Encryption Setting] (p. 8-31)	
	8 [Stamp Settings]	1 [Apply Stamps] (p. 8-32)	[Printing]
			[Sending]

8.2 User mode settings

8.2.1 Creating a User Box

Public, Personal, or Group User Box

Create a Public, Personal, or Group User Box. You can configure the following items when create a User Box.

Reference

- To change the setting of a created User Box, select the target User Box and press [Edit].
- If [Edit] is selected, you cannot change the User Box number.
- To delete a created User Box, select the target User Box and press [Delete].

Page (1/2)

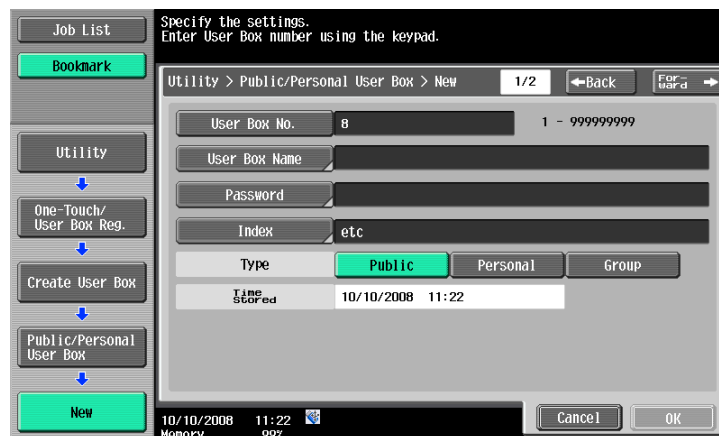

Item	Description
[User Box No.]	Automatically displays an unassigned number. To specify a User Box number, press [User Box No.], and use the keypad to enter the User Box number between 1 and 999999999.
[User Box Name]	Press [User Box Name], and enter the User Box name in the control panel (up to 20 characters). Specifying different User Box numbers enables you to create User Boxes with the same name.
[Password]	Specify a password to limit access to the User Box. Press [Password], and enter the password in the control panel (up to 8 characters).
[Index]	Select the index type.
[Type]	Select [Public], [Personal], or [Group] depending on User Authentication or Account Track settings. If [Personal] is selected, specify the owner user. To select the owner user, use the owner user change page. If [Group] is selected, specify the owner account. To select the owner account, use the Change Owner screen.

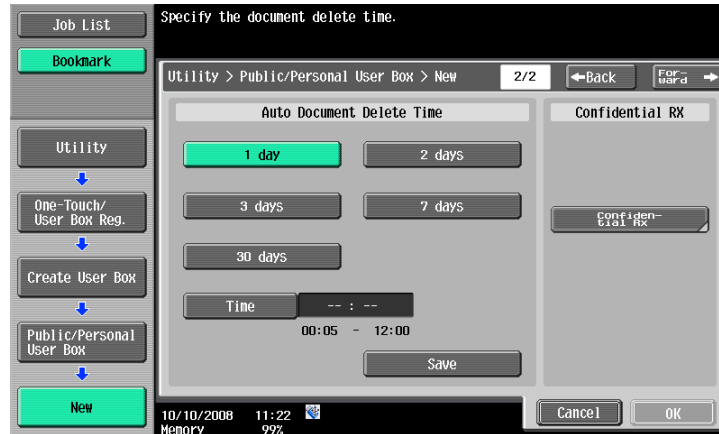

Item	Description
[Auto Document Delete Time]	<p>Specify the period from the date/time when a document was saved in or last retrieved from a User Box to the date/time when it is to be deleted automatically.</p> <ul style="list-style-type: none"> In Delete Time, you can specify the time in addition to the number of days. To specify the time, enter the numeric value on a 1-minute basis in the range from 5 minutes to 12 hours. When not deleting a document, select [Save]. Depending on the settings in Administrator Settings, you may not be able to operate.
[Confidential RX]	<p>This item appears when the optional Fax Kit is installed. Select whether to add the confidential RX function to a User Box. When adding the confidential RX function, enter the confidential RX password.</p> <ul style="list-style-type: none"> For confirmation, enter the confidential RX password again.

Delete Empty User Box(es) (Administrator Settings)

Automatically searches for and deletes an empty User Box if the Public, Personal, or Group User Box is created in Administrator Settings. Press [Delete Empty User Box(es)] in the Create User Box screen.

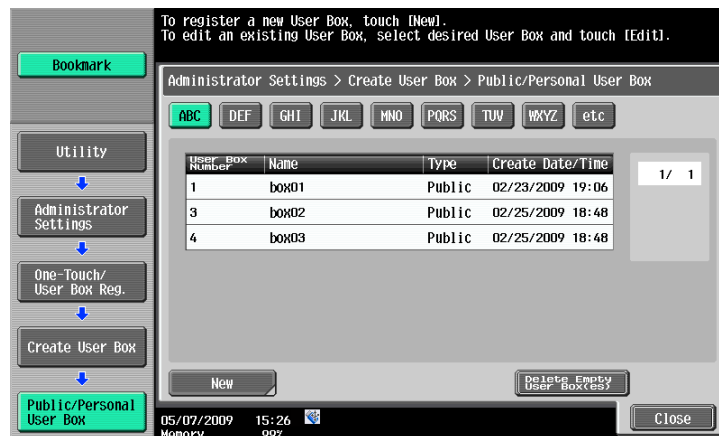

Bulletin Board User Box

Create a Bulletin Board User Box. You can create up to 10 Bulletin Board User Boxes. The available setting items are as follows.

Reference

- To change the setting of a created User Box, select the target User Box and press [Edit].
- If [Edit] is selected, you cannot change the User Box number.
- To delete a created User Box, select the target User Box and press [Delete].

Specify the settings.
Enter User Box number using the keypad.

Utility > Bulletin Board User Box > New 1/2

User Box No. 6 1 - 999999999

User Box Name

Password

Type Public Personal Group

Time stored 10/10/2008 11:23

10/10/2008 11:23
Memory 99%

Cancel OK

Item	Description
[User Box No.]	Automatically displays an unassigned number. To specify a User Box number, press [User Box No.], and use the keypad to enter the User Box number between 1 and 999999999.
[User Box Name]	Press [User Box Name], and enter the User Box name in the control panel (up to 20 characters). Specifying different User Box numbers enables you to create User Boxes with the same name.
[Password]	Specify a password to limit access to the User Box. Press [Password], and enter the password in the control panel (up to 8 characters).
[Type]	Select [Public], [Personal], or [Group] depending on User Authentication or Account Track settings. If [Personal] is selected, specify the owner user. To select the owner user, use the owner user change page. If [Group] is selected, specify the owner account. To select the owner account, use the Change Owner page.

Specify the document delete time.

Utility > Bulletin Board User Box > New 2/2

Auto Document Delete Time

1 day 2 days

3 days 7 days

30 days

Time 00:05 - 12:00

Save

10/10/2008 11:23
Memory 99%

Cancel OK

Item	Description
[Auto Document Delete Time]	Specify the period from the date/time when a document was saved in or last retrieved from a User Box to the date/time when it is to be deleted automatically. <ul style="list-style-type: none"> In Delete Time, you can specify the time in addition to the number of days. To specify the time, enter the numeric value on a 1-minute basis in the range from 5 minutes to 12 hours. When not deleting a document, select [Save].

Relay User Box

You can create up to five Relay User Boxes. The creation and editing setting items are as follows.

Reference

- To change the setting of a created User Box, select the target User Box and press [Edit].
- If [Edit] is selected, you cannot change the User Box number.
- To delete a created User Box, select the target User Box and press [Delete].

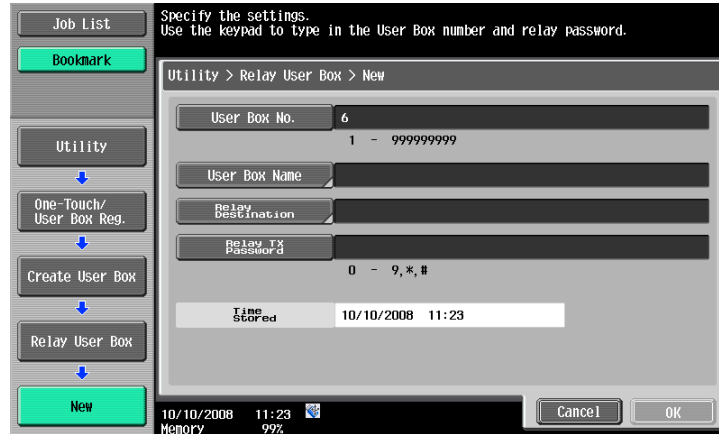

Item	Description
[User Box No.]	Automatically displays an unassigned number. To specify a User Box number, press [User Box No.], and use the keypad to enter the User Box number between 1 and 999999999.
[User Box Name]	Press [User Box Name], and enter the User Box name in the control panel (up to 20 characters). Specifying different User Box numbers enables you to create User Boxes with the same name.
[Relay Destination]	Select a relay destination to send data from the Relay User Box. Pre-register the relay destination as a group destination. <ul style="list-style-type: none"> • When registering a group destination as a relay destination, be sure to set Abbreviation Dial in the group destination in advance.
[Relay TX Password]	Specify a password to limit access to the User Box. Press [Relay TX Password], and enter the password in the control panel (up to 8 characters).



Reference

For details on how to register the header or footer, refer to the [User's Guide Network Scan/Fax/Network Fax Operations].

8.2.2 Custom Display Settings - User Box Setting

You can customize the User Box screen to fit your operating environment.

Default Tab

Specify the User Box page to be displayed after pressing [User Box] key on the control panel.

Reference

- [Public]: Displays the Public User Box page.
- [Personal]: Displays the Personal User Box page when User Authentication is enabled.
- [System]: Displays the System User Box page.
- [Group]: Displays the Group User Box page when Account Track is enabled.

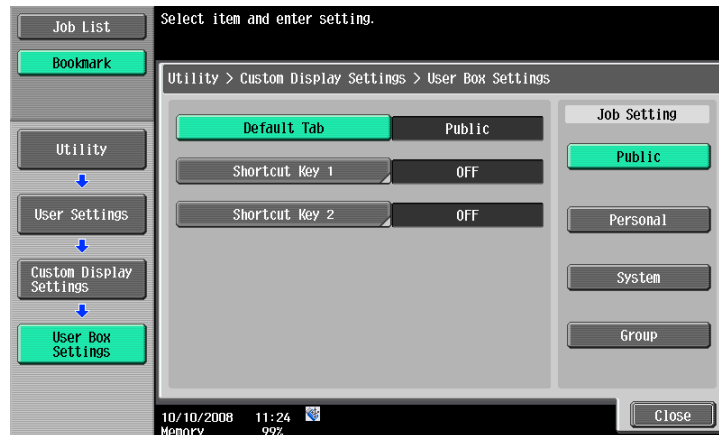

Shortcut key

This function enables you to add up to two shortcut keys in the area on the lower right of the page. It is available when registering the frequently used System User Box as a shortcut key.

Reference

- A shortcut key is displayed only in the User Box mode after pressing the [User Box] key. Switching to the Fax/Scan or Copy mode does not display the target User Box shortcut key.
- If Shortcut Key 1 and 2 is configured, [Language Selection] is not displayed.

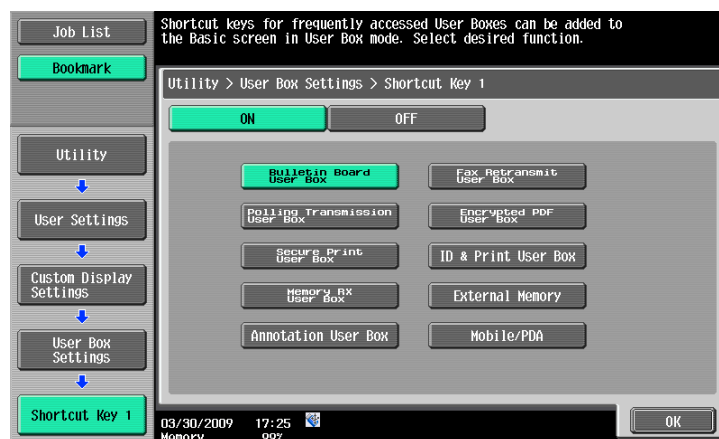

8.2.3 Cellular Phone/PDA Setting - Link File Error Notification

This function enables you to specify processing to be performed if you cannot access a link file when attempting to print an XHTML file from a cellular phone or PDA. (Default: [ON])

- [ON]: Prints a link file in a black frame.
- [OFF]: Does not print a link file part.

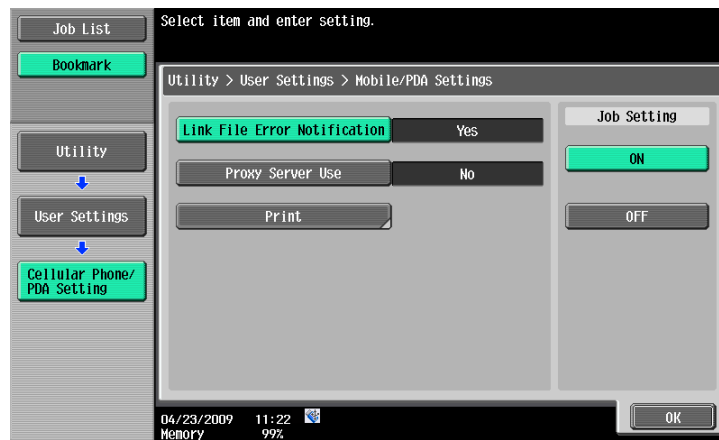

8.2.4 Cellular Phone/PDA Setting - Proxy Server Use

This function enables you to specify whether to use a proxy server to access a link file when printing an XHTML file from a cellular phone or PDA. (Default: [OFF])

- [ON]: Uses a proxy server.
- [OFF]: Does not use a proxy server.

Reference

- To use a proxy server for connection, register the desired proxy server in [Administrator Settings] - [Network Settings] - [WebDAV Settings] - [WebDAV Client Settings] - [Proxy Server Address]. For details, refer to [User's Guide Network Administrator].

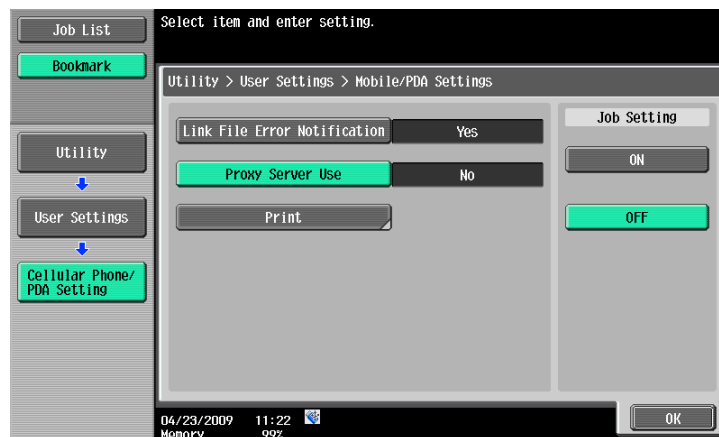

8.2.5 Cellular Phone/PDA Setting - Print Settings

When using a cellular phone or PDA to print a document through this machine, configure print settings.



Basic - Print

Select 1-Sided or 2-Sided.

Basic - Color

Select Full Color or Black.

Basic - Paper

Select the printing paper size if the sent data does not contain paper size information.

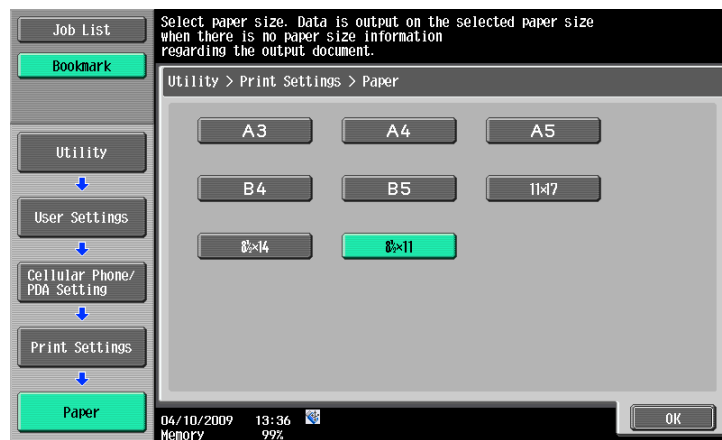

Basic - Finishing

Specify Fold/Bind, Staple, or Punch.

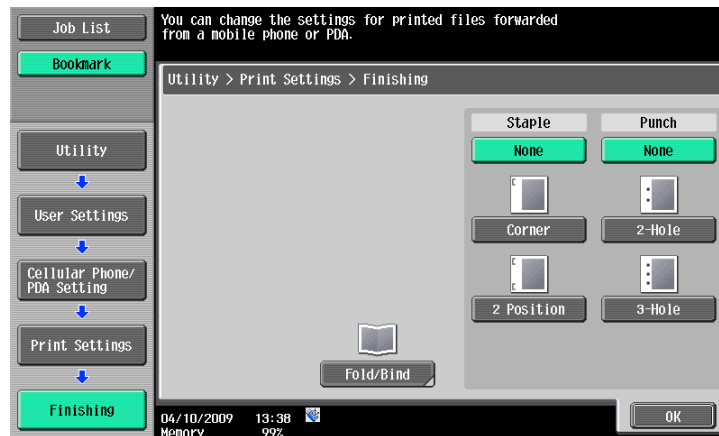

Application - Margin

Select the margin position.

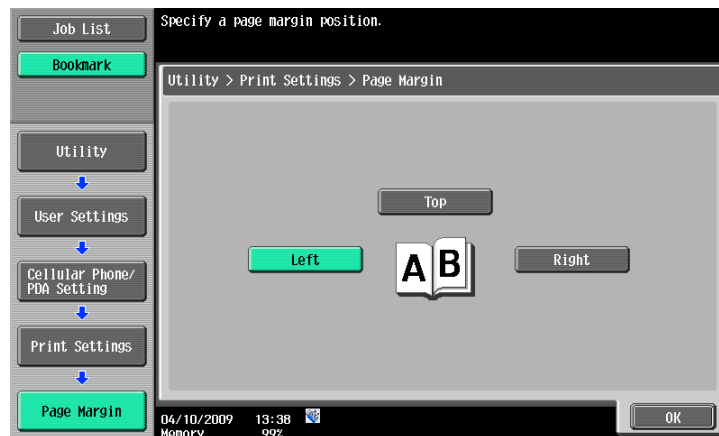

Application - Stamp/Composition - Date/Time

For the setting procedure, refer to page 7-22.

Application - Stamp/Composition - Page Number

For the setting procedure, refer to page 7-23.

Application - Stamp/Composition - Stamp

For the setting procedure, refer to page 7-24.

Application - Stamp/Composition - Copy Security - Copy Protect

For the setting procedure, refer to page 7-25.

Application - Stamp/Composition - Copy Security - Copy Guard

For the setting procedure, refer to page 7-27.

Application - Stamp/Composition - Copy Security - Password Copy

For the setting procedure, refer to page 7-28.

Application - Stamp/Composition - Stamp Repeat

For the setting procedure, refer to page 7-30.

8.3 Administrator Settings

8.3.1 User Box permissions

User types

This machine is intended for users of various positions. The User Box function therefore provides [User Box Administrator] in addition to the administrator of this machine. The following shows the users and their available User Box types.

Reference

- To log in to this machine as the User Box administrator, execute the following steps when setting User Authentication.
 - Enter "boxadmin" in the User Name box.
 - Enter the password specified in page 8-26 in the Password box.

Item	Description
Public user	When user authentication is disabled, every user is logged in as a public user.
Registered user	User registered by the administrator when User Authentication is enabled.
User Box administrator	User who logs in as the User Box administrator when User Authentication is enabled. This user can access all User Boxes regardless of whether a password is specified.
Administrator	User who manages this machine. This user can create, change, or delete all User Boxes regardless of whether a password is specified.

Public User Box and Personal or Group User Box

The following shows the available functions of the (1) Public User Box that can be accessed by all users and the (2) Personal or Group User Box that can be accessed only by specific users.

Function	Create User Box		Check, download, or delete a document		Change User Box setting		Delete User Box	
	Public	Personal or Group	Public	Personal or Group	Public	Personal or Group	Public	Personal or Group
User Box type								
Public user	<input type="radio"/>	–	<input type="radio"/>	–	<input type="radio"/>	–	<input type="radio"/>	–
Registered user	<input type="radio"/>	<input type="radio"/>	<input type="radio"/>	<input type="radio"/> *1	<input type="radio"/>	<input type="radio"/> *1	<input type="radio"/>	<input type="radio"/> *1
User Box administrator	<input type="radio"/> *2	<input type="radio"/> *2	<input type="radio"/> *2	<input type="radio"/> *2	<input type="radio"/> *2	<input type="radio"/> *2	<input type="radio"/> *2	<input type="radio"/> *2
Administrator	<input type="radio"/>	<input type="radio"/>	–	–	<input type="radio"/> *2	<input type="radio"/> *2	<input type="radio"/> *2	<input type="radio"/> *2

*1 The registered users can handle only the User Boxes that were created by them.

*2 The User Box administrator and administrator can handle User Boxes without entering the password even if it is specified for the User Boxes.

8.3.2 Creating a User Box

You can register a new User Box. The following describes the types of the User Boxes that can be registered.

Reference

- Disabling User Authentication or Account Track saves the User Box registered as a Personal or Group User Box as a Public User Box. The User Box name however remains unchanged.
- When User Authentication or Account Track is enabled, enter the ID and password when logging in to this machine. After this, be sure to press [Login] or the **Access** key in the control panel to complete authentication processing. If authentication is not completed, you cannot create a Personal or Group User Box.
- When the optional **Fax Kit** is installed, you can configure confidential RX (F-Code TX) settings as the Public, Personal, or Group User Box extension function. For details on the confidential RX function, refer to the [User's Guide Network Scan/Fax/Network Fax Operations].
- When the setting for User Authentication is configured, you can specify a User Box administrator. A User Box administrator can access all Public, Personal, and Group User Boxes.

Item	Description
Public User Box	Public User Box that can be accessed by everyone.
Personal User Box	Personal User Box that can be accessed by only the login user when User Authentication is enabled.
Group User Box	User Box that can be accessed by only the user in the login account when Account Track is enabled.
Bulletin Board User Box	User Box used to perform Bulletin Polling TX or RX with F codes. This item is available when the optional Fax Kit is installed.
Relay User Box	User Box used to save relay data when using this machine as a relay distribution station to perform relay distribution with F codes. This item is available when the optional Fax Kit is installed.
Annotation User Box	User Box used to print or send a saved document with the date/time or filing number image. Specify the type of the text to be added when using this User Box. When registering this User Box, specify the administrator mode.

Reference

- If [Password Rules] is enabled, you cannot create the password that is less than eight characters.
- When the registered User Box password contains less than eight characters, change it to eight characters before setting Password Rules to ON. For details on Password Rules, refer to the [User's Guide Copy Operations].

8.3.3 Creating Public, Personal, or Group User Box

For details, refer to page 8-6.

8.3.4 Creating Bulletin Board User Box

For details, refer to page 8-7.

8.3.5 Creating Relay User Box

For details, refer to page 8-9.

8.3.6 Creating Annotation User Box

Create an Annotation User Box. You can configure the following items when create a User Box.

Reference

- To change the setting of a created User Box, select the target User Box and press [Edit].
- If [Edit] is selected, you cannot change the User Box number.
- To delete a created User Box, select the target User Box and press [Delete].

Page (1/3)

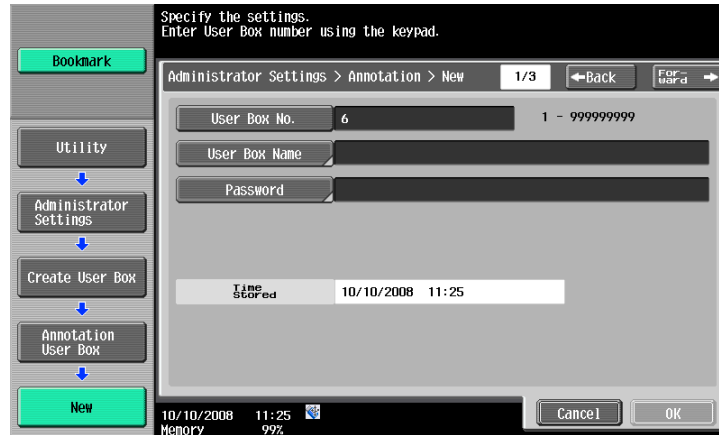

Item	Description
[User Box No.]	Automatically displays an unassigned number. To specify a User Box number, press [User Box No.], and use the keypad to enter the User Box number between 1 and 999999999.
[User Box Name]	Press [User Box Name], and enter the User Box name in the control panel (up to 20 characters). Specifying different User Box numbers enables you to create User Boxes with the same name.
[Password]	Specify a password to limit access to the User Box. Press [Password], and enter the password in the control panel (up to 8 characters).

Reference

- If [Password Rules] is enabled, you cannot create the password that is less than eight characters.
- When the registered User Box password contains less than eight characters, change it to eight characters before setting Password Rules to ON. For details on Password Rules, refer to the [User's Guide Copy Operations].

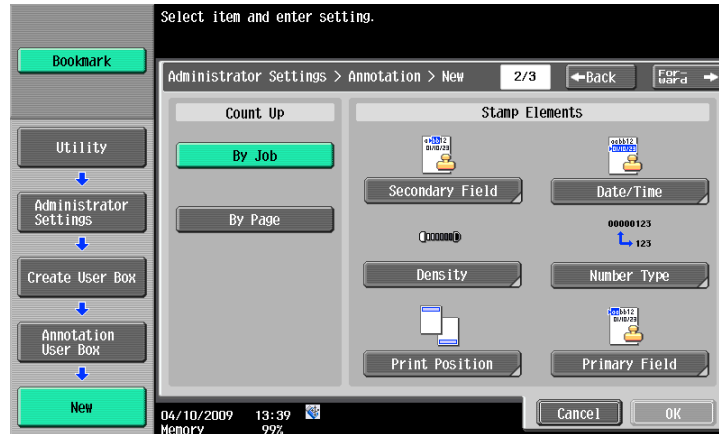

Item	Description
[Count Up]	Select whether to count the annotation number by job or by page.
[Secondary Field]	Add text to the number to be printed (up to 20 characters).
[Date/Time]	Select the format to display the date and time to be printed.
[Density]	Select the density of the annotation numbers to be printed.
[Number Type]	Select the output format (number of digits) of the annotation numbers to be printed.
[Print Position]	Select the printing position.
[Primary Field]	Add any text (up to 40 characters).

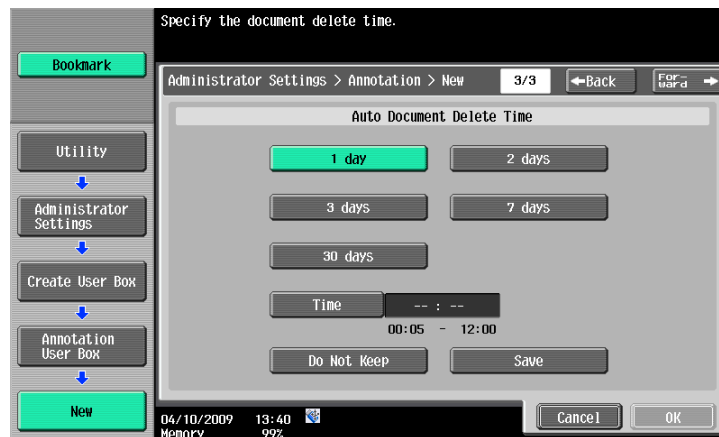

Item	Description
[Auto Document Delete Time]	<p>Specify the period from the date/time when a document was saved in or last retrieved from a User Box to the date/time when it is to be deleted automatically.</p> <ul style="list-style-type: none"> In Delete Time, you can specify the time in addition to the number of days. To specify the time, enter the numeric value on a 1-minute basis in the range from 5 minutes to 12 hours. When not deleting a document, select [Save]. To use a document to give an annotation only without saving or using it for copying, select [Do Not Keep].

8.3.7 Maximum Number of User Boxes

Specify the maximum number of User Boxes that can be created for each user.

Public, Personal, or Group User Box

Select [Public], [Personal], or [Group] depending on User Authentication or Account Track settings.

Max. No. Of Use Boxes

To specify the maximum number of User Boxes, select [ON]. To not specify the limit and allow users to create an infinite number of User Boxes, select [OFF].

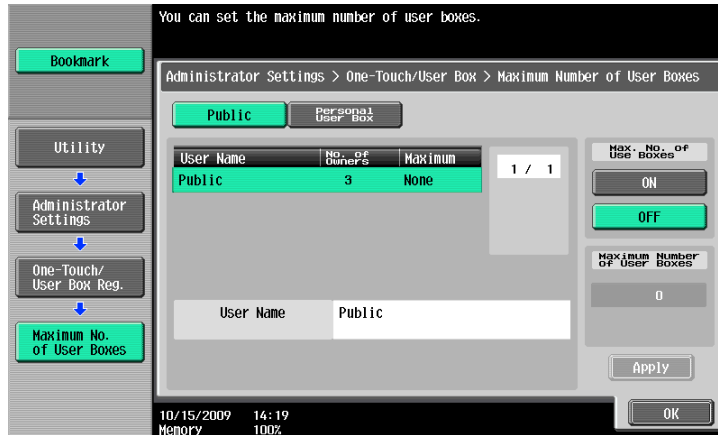

Maximum Number of User Boxes

The allowable range of the maximum number of User Boxes is 0 to 1000. Use the keypad to enter the maximum number of User Boxes, and press [Apply] to determine it.

Reference

- If the maximum number of User Boxes is set to "0", you cannot create new ones.
- When the selected user already sets the number of User Boxes to 3, the allowable range of the maximum number of User Boxes changes 3 to 1000.

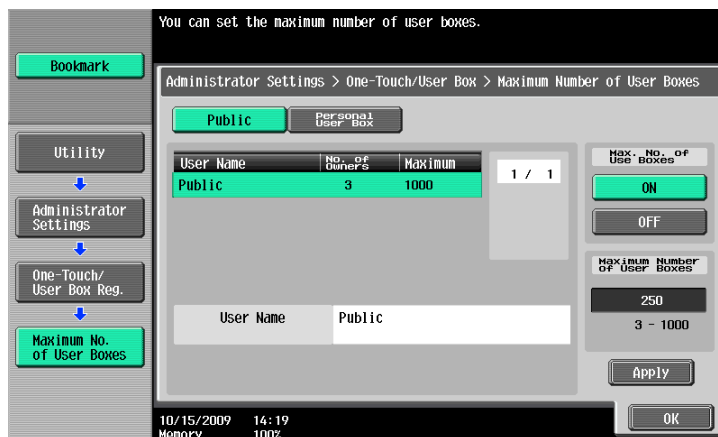

8.3.8 User Box Setting

Delete Unused User Box

Delete a User Box with no document saved, as an unnecessary User Box. To delete a User Box, confirm the message that appears and select [Yes].

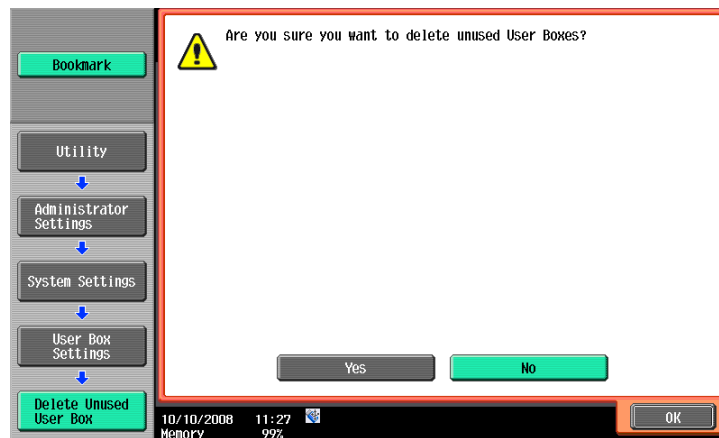

Delete Secure Print Documents

This function deletes all documents saved in the Secure Document User Box. To delete the User Box, confirm the message and select [Yes].

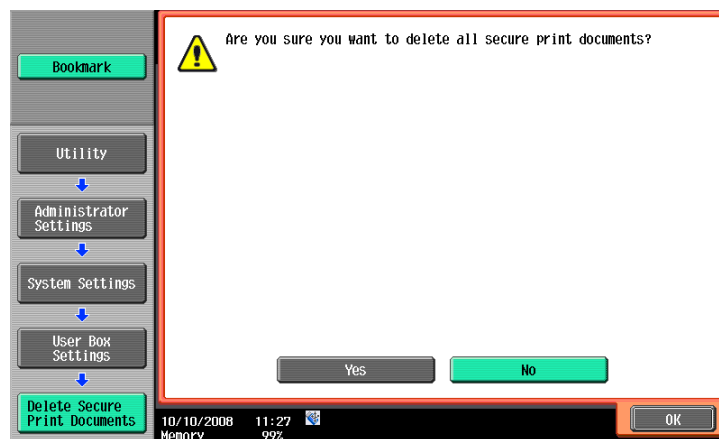

Auto Delete Secure Document

Specify the period from the date/time when a secure document was saved or last retrieved to the date/time when it is to be deleted automatically.

Reference

- In Delete Time, specify 5 minutes to 12 hours (on a 1-minute basis), 1 day, 2 days, 3 days, 7 days, or 30 days.
- When not deleting a document, select [Save].



Encrypted PDF Delete Time

Specify the period from the date/time when an encrypted PDF document was saved or last retrieved to the date/time when it is to be deleted automatically.

Reference

- In Delete Time, specify 5 minutes to 12 hours (on a 1-minute basis), 1 day, 2 days, 3 days, 7 days, or 30 days.
- When not deleting a document, select [Save].

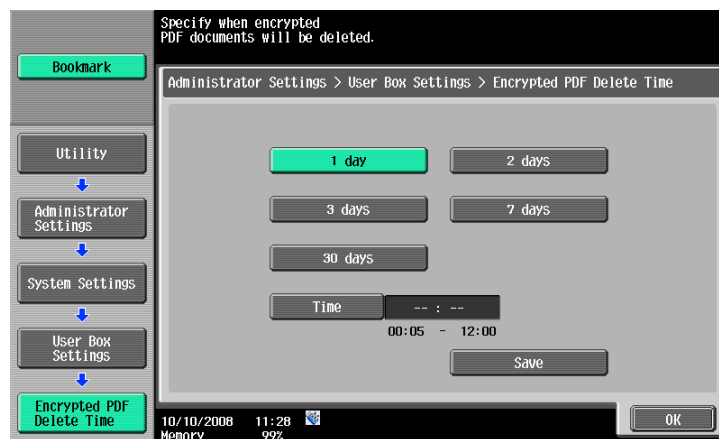

ID & Print Delete Time

Specify the period from the date/time when a document was saved in or last retrieved from the ID & Print User Box to the date/time when it is to be deleted automatically.

Reference

- In Delete Time, specify 5 minutes to 12 hours (on a 1-minute basis), 1 day, 2 days, 3 days, 7 days, or 30 days.
- When not deleting a document, select [Save].

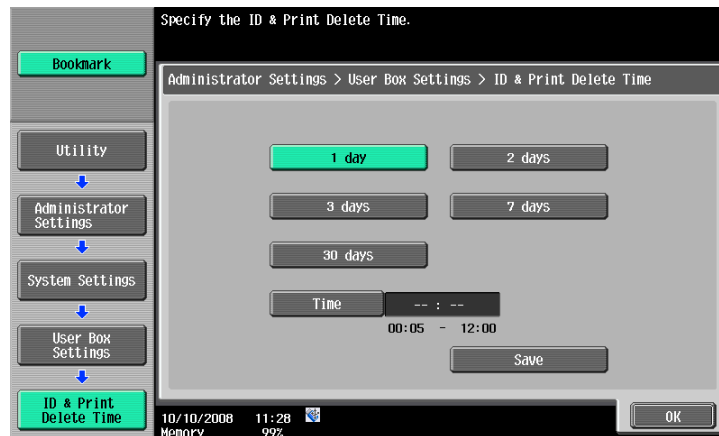

Document Hold Setting

Specify whether to save a document in a User Box when sending or printing it.

Reference

- When deleting a document after printing or sending, select [Yes]. To display a deletion confirmation screen when printing or sending, select [ON] on the deletion selection screen.
- To delete a document after printing or sending the document, select [No].

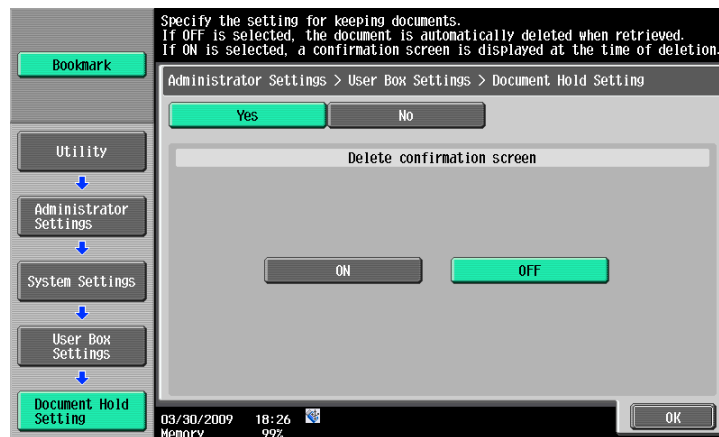

External Memory Function Settings

Set the function of the external memory connected to this machine to ON or OFF.

Reference

- A function to save a document in external memory is set to OFF (not saved) in the factory setting. It is also set to OFF (not saved) in the user function setting when User Authentication is enabled. To save a document in external memory, change the setting to enable you to save a document in Administrator Settings.

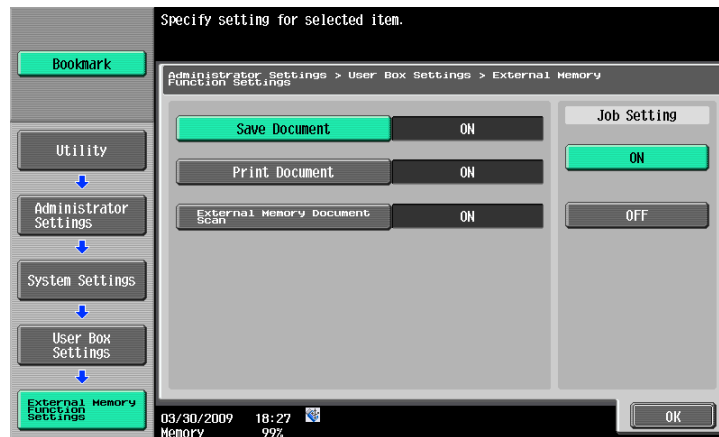

Item	Description
[Save Document]	Select whether to save (ON) or not save (OFF) scanned documents or documents stored in a User Box to the external memory.
[Print Document]	Select whether to print (ON) or not print (OFF) documents saved in the external memory using the [Use/File] function.
[External Memory Document Scan]	Scan a document in the external memory and select whether to save (ON) or not save (OFF) it in a User Box.

Allow/Restrict User Box

Specify whether to release functions so that the user can create, edit, or delete a User Box.

Reference

- To enable the user to handle those functions, select [Allow].
- When not enabling the user to handle those functions, select [Prohibit]. Only the administrator can then create, edit, or delete a User Box.

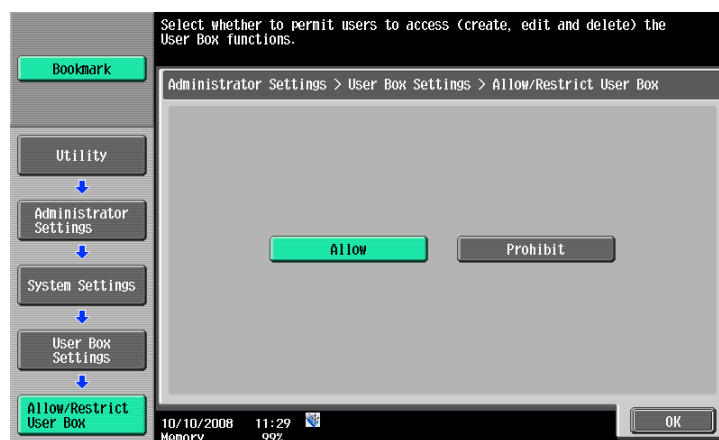

ID & Print Delete after Print Setting

Select whether to check that the document saved in the ID & Print User Box has been deleted after printed.

Reference

- To check with the user whether to delete the target document, select [Confirm with User].
- To delete the target document without checking with the user after printing, select [Always Delete].



Document Delete Time Setting

This function enables the administrator to specify the period from the date/time when a document was saved in or retrieved from a User Box to the date/time when it is to be deleted automatically when the user cannot specify the document deletion time.

When automatically specifying the document deletion time, select [Yes] and set the deletion time.

Reference

- In Delete Time, specify 5 minutes to 12 hours (on a 1-minute basis), 1 day, 2 days, 3 days, 7 days, or 30 days.
- When not deleting a document, select [Save].

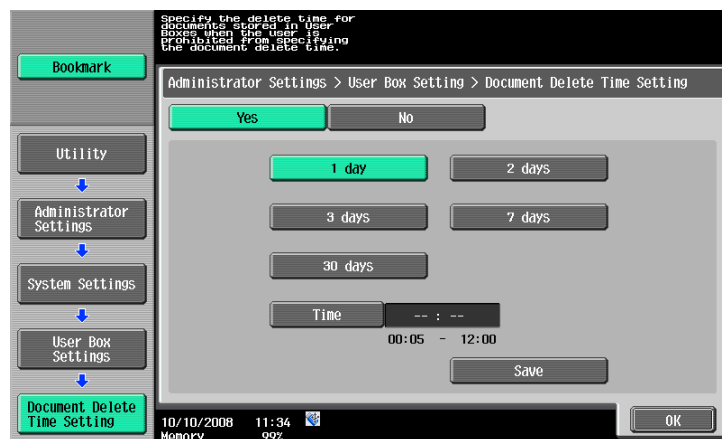

ID & Print Settings

Configure settings for ID & Print User Box.



Item	Description
[ID & Print]	[ON]: Saves all the Normal Print and Authentication & Print jobs, which were requested from a registered user, in the ID & Print User Box. [OFF]: Saves the Authentication & Print job, which was requested from a registered user, in the ID & Print User Box. The Normal Print job is output without being saved in the User Box.
[Public User]	[Print Immediately]: Outputs a public user job or user-unauthorized job without saving it in the User Box. [Save]: Saves a public user job or user-unauthorized job in the ID & Print User Box.

Reference

- A public user job is printed or saved when public user printing is enabled.
- A user-unauthorized job is printed or saved when Print without Authentication is enabled.
- For details on printing by public users and Print without Authentication, refer to the [User's Guide Print Operations].

8.3.9 Cellular Phone/PDA Setting

Select whether to allow or restrict the function for using a cellular phone or PDA.

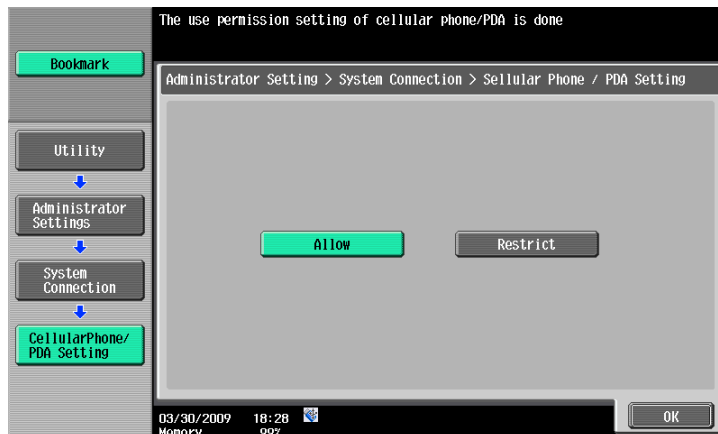

8.3.10 User Box Administrator Setting

The User Box administrator is available when User Authentication is enabled. If you log in to this machine as the User Box administrator, you can reference the contents of all the created User Boxes regardless of whether the password is specified.

Setting User Box administrator

To set a User Box administrator, select [Allow], and press [Password Setting] to register the User Box administrator's password.

Reference

- For confirmation, enter the password twice.
- If [Password Rules] is enabled, you cannot create the password that is less than eight characters.
- When the registered User Box password is less than eight characters, change it to eight characters before enable "Password Rules". For details on Password Rules, refer to the [User's Guide Copy Operations].

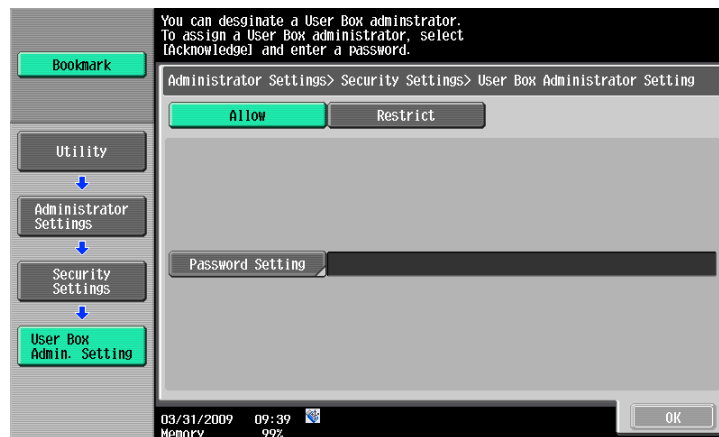

Logging in to this machine as the User Box administrator

Enter the following items in the login screen.

User name: boxadmin

Password: Password determined in the User Box Administrator Setting screen

Administrator's available functions

The following functions are available when you log in as the User Box administrator.

- Creating Public, Personal, or Group User Box
- Checking, downloading, or deleting documents saved in all User Boxes
- Changing all User Box settings
- Deleting all User Boxes

8.3.11 Security Details

Security Print Only

Use this setting to specify to enable only Secure Print when issuing the print command from the printer driver. To print a document, you must enter the ID and password.



8.3.12 HDD Settings

Check HDD Capacity

You can check the occupied and free spaces in the HDD.

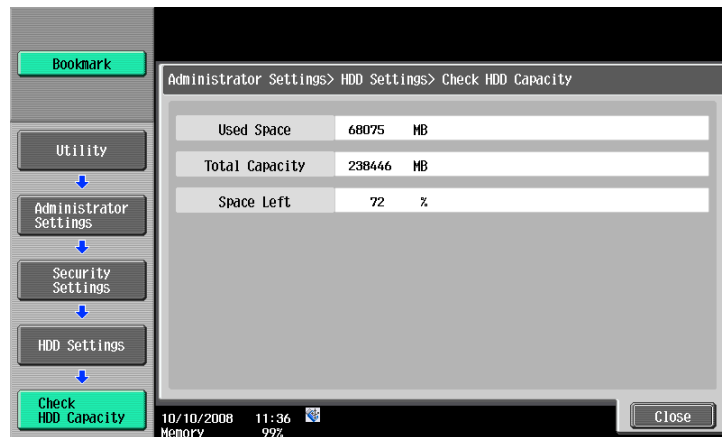

Overwrite Temporary Data

You can specify how to overwrite and delete HDD data.

When image data saved in the HDD becomes unnecessary, this function overwrites meaningless data in all areas that contain the image data to destroy the original data. This function also destroys the non-image data structure to prevent a data leak when the installed HDD has been stolen.



The available setting items are as follows. (Default: Mode 1)

Item	Description
[Mode 1]	Overwritten with 0x00
[Mode 2]	Overwritten with 0x00 → Overwritten with 0xff → Overwritten with letter "A" (0x61) → Verified
[Encryption Priority]	Performs encryption processing at a higher security level. In HDD Encryption Setting, however, data overwriting is performed unlike [Mode 1] or [Mode 2] setting. Always specify [Encryption Priority].
[Overwrite Priority]	In HDD Encryption Setting, however, data overwriting is performed based on [Mode 1] or [Mode 2] setting.

Reference

- When changing Encryption Priority or Overwrite Priority setting, format the HDD after rebooting this machine. However, be careful that data is erased by formatting the HDD.
- For the data erased by formatting the HDD, refer to page 8-31.

Overwrite All Data

This function overwrites and deletes all data in the total capacity of the HDD.

- ✓ This function is available when disposing of this machine. Before performing this function, be sure to consult your service representative.
- ✓ While overwriting and deleting data, do not turn the main power switch off and on.
- ➔ To overwrite and delete data, select the HDD overwrite method, and press [Delete].
Overwrite and delete processing is performed after this machine has been rebooted.

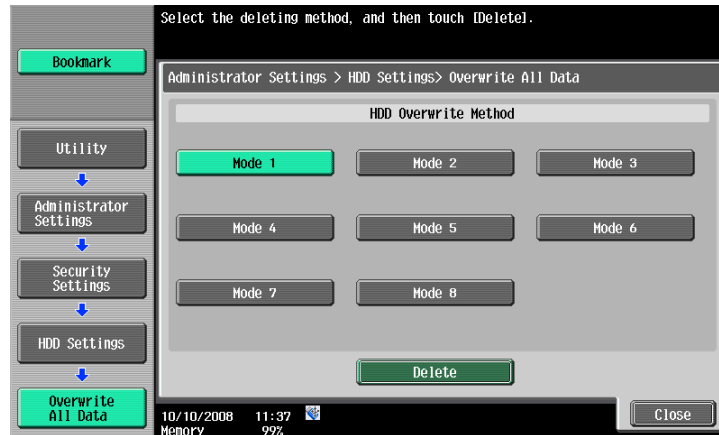

The available setting items are as follows.

Item	Description
[Mode 1]	Overwritten with 0x00
[Mode 2]	Overwritten with 1-byte random numbers → Overwritten with 1-byte random numbers → Overwritten with 0x00
[Mode 3]	Overwritten with 0x00 → Overwritten with 0xff → Overwritten with 1-byte random numbers → Verified
[Mode 4]	Overwritten with 1-byte random numbers → Overwritten with 0x00 → Overwritten with 0xff
[Mode 5]	Overwritten with 0x00 → Overwritten with 0xff → Overwritten with 0x00 → Overwritten with 0xff
[Mode 6]	Overwritten with 0x00 → Overwritten with 0xff → Overwritten with 0x00 → Overwritten with 0xff → Overwritten with 0x00 → Overwritten with 0xff → Overwritten with specified 512-byte data
[Mode 7]	Overwritten with 0x00 → Overwritten with 0xff → Overwritten with 0x00 → Overwritten with 0xff → Overwritten with 0x00 → Overwritten with 0xff → Overwritten with 0xaa
[Mode 8]	Overwritten with 0x00 → Overwritten with 0xff → Overwritten with 0x00 → Overwritten with 0xff → Overwritten with 0x00 → Overwritten with 0xff → Overwritten with 0xaa → Verified

Reference

- It takes approximately 40 minutes to execute Mode 1.

HDD Lock Password

You can specify the password to lock the HDD.

- ✓ Be sure to keep the specified password carefully so that you will never forget it. Forgetting the password will require a large amount of recovery work.

→ Specify the password, and reboot this machine.

The HDD password is specified.



Reference

- Enter the HDD password using 20 characters. Note that all the characters must not be the same.
- If you have already specified the HDD password, [Edit] and [Release] appears. You can change or release the HDD password.

Format HDD

This function formats the HDD.

- ✓ To turn the main power switch off and on, first turn the main power off, and then turn it on after 10 or more seconds have elapsed. Not doing so may result in an operation failure.
- ➔ To format the HDD, select [Yes] to follow the displayed messages. After formatting has been completed, reboot this machine.

Reference

- Using the **PageScope Web Connection** export function backs up user registration information or address data. For details, refer to the **PageScope Web Connection** online help.
- The following shows the data deleted by formatting the HDD.
 - Program
 - Address Book
 - Authentication method setting
 - User authentication setting
 - Account track setting
 - User Boxes
 - User Box setting
 - Documents in User Boxes
 - Confidential User Box setting
 - Bulletin Board User Box setting



HDD Encryption Setting

You can configure HDD encryption setting. Specifying a 20-character encryption passphrase for the HDD prevents the user from easily reading the data saved in the HDD.

- ✓ Be sure to keep the specified encryption passphrase carefully so that you will never forget it.
- ✓ The encryption passphrase setting must be configured by the administrator of this machine.
- ✓ To turn the main power switch off and on, first turn the main power off, and then turn it on after 10 or more seconds have elapsed. Not doing so may result in an operation failure.
- ➔ Specify the encryption passphrase, and reboot this machine.
The encryption passphrase setting then becomes available.

Reference

- Enter the encryption passphrase using 20 characters. Note that all the characters must not be the same.
- Encryption passphrase setting becomes available after this machine has been rebooted.

8.3.13 Stamp Settings

Apply Stamps

This function applies the predetermined stamp to all documents to be output from this machine, ensuring security. Specify whether to apply a stamp when printing or sending. To apply stamps, select [Apply], and then configure settings for the stamp to be added continuously.

Reference

- The following shows the types of the stamps that can be applied to the printed data.
 - Date/Time
 - Page Number
 - Stamp
 - Copy Security (Copy Protect, Copy Guard, Password Copy)
 - Stamp Repeat
 - Header/Footer
 - Registered Overlay
- The following shows the types of the stamps that can be applied to the transmitted data.
 - Date/Time
 - Page Number
 - Stamp
 - Header/Footer



Reference

For details on the stamp setting, refer to page 7-22.

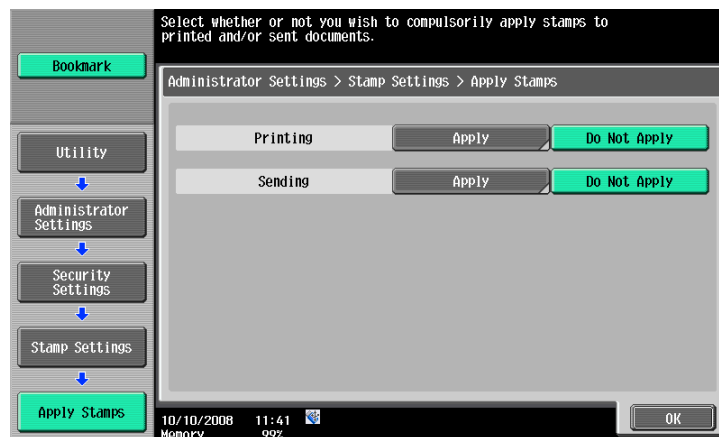



PageScope Web Connection

9 PageScope Web Connection

9.1 Using PageScope Web Connection

PageScope Web Connection is a device control utility provided by the HTTP server built in the printer controller. Using a Web browser on a computer connected to the network, you can change machine settings and check the status of the machine. Using this utility, you can configure some settings, which are to be handled in the control panel of this machine, through your computer, and also smoothly enter characters.

9.1.1 Operating environment

Operating environment

Network	Ethernet (TCP/IP)
Applications on computer	<p>Web browser: <For Windows NT4.0/2000/XP/Server 2003/Vista></p> <ul style="list-style-type: none"> • Microsoft Internet Explorer Ver. 6/7/8 (JavaScript and Cookies enabled) • Netscape Navigator 7.02 or later (JavaScript and Cookies enabled) • Mozilla Firefox 1.0 or later (JavaScript and Cookies enabled) <p><For Macintosh MacOS 9.x/MacOS X></p> <ul style="list-style-type: none"> • Netscape Navigator 7.02 or later (JavaScript and Cookies enabled) • Mozilla Firefox 1.0 or later (JavaScript and Cookies enabled) <p><For Linux></p> <ul style="list-style-type: none"> • Netscape Navigator 7.02 or later (JavaScript and Cookies enabled) • Mozilla Firefox 1.0 or later (JavaScript and Cookies enabled) <p>Adobe® Flash® Player:</p> <ul style="list-style-type: none"> • Plug-in Ver.7.0 or later required to select Flash as the display format. • Plug-in Ver.9.0 or later required to use the Data Management Utility (font/macro data management).

9.1.2 Accessing PageScope Web Connection

- ✓ Start the Web browser to access **PageScope Web Connection**.
- ✓ If User Authentication is enabled, enter the user name and password. For details, refer to page 9-11.
- ✓ For details on setting the IP address of this machine, refer to [User's Guide Network Administrator].
- ✓ **PageScope Web Connection** has two view modes: Flash and HTML. For details, refer to page 9-9.

1 Start the Web browser.

2 Enter the IP address of the machine in the URL field, and then press [Enter].
http://<IP address of the machine>/

Example: When the IP address of this machine is 192.168.1.20:

- http://192.168.1.20/

When IPv6 is set to "ON" while a browser other than Internet Explorer 6 is used:

- Enter the IPv6 address enclosed in brackets ([]).
- http://[IPv6 address of the machine]/

Example: When the IPv6 address of this machine is fe80::220:6bff:fe10:2f16:

- http://[fe80::220:6bff:fe10:2f16]/
- If IPv6 is set to "ON" while Internet Explorer is used, add "fe80::220:6bff:fe10:2f IPv6_MFP_1" to the hosts file in advance, and specify the address with the domain name.

The main menu or login page appears.

9.1.3 Web browser cache

The Web browser has the cache function; therefore, the latest information may not be shown in the page displayed using **PageScope Web Connection**. Using the cache function may result in an operation failure. When using **PageScope Web Connection**, disable the cache function on the Web browser.

Reference

- Some Web browser versions may provide different menus and item names. For details, refer to the Help for the Web browser.
- With the cache function enabled, timeout occurs in the administrator mode, and after that, how many time you try to access, just timeout recurs. It results in the control panel of this machine being locked, and you cannot handle the control panel. In this case, turn the main power off, and then turn it on again. To avoid this problem, disable the cache function.

For Internet Explorer

- 1 Select [Internet Options] in the [Tools] menu.
- 2 In the [General] tab, select [Temporary Internet files] - [Settings].
- 3 Select [Every visit to the page], and click [OK].

For Netscape Navigator

- 1 Select [Preferences] in the [Edit] menu.
- 2 In [Category] on the left, select [Advanced] - [Cache].
- 3 In [Document in cache is compared to document on network], select [Every time].

For Mozilla Firefox

- 1 Select [Options] in the [Tools] menu.
- 2 Select [Privacy], and then click [Settings] in the Private Data section.
- 3 Select the [Cache] check box under [Private Data] select the [Clear private data when closing Firefox] check box under [Settings], and then click [OK].

9.1.4 Online help function

After logging in to **PageScope Web Connection**, click  ; you can display the online help for the currently configured function.

Reference

- To display the online help, connect your computer to the Internet.

9.2 Login and logout

9.2.1 Login and logout flows

Accessing with **PageScope Web Connection** displays the login page when User Authentication or Account Track is enabled, and displays the login page in the public user mode when User Authentication or Account Track is not enabled. When re-logging in to this machine as a different user or as an administrator, log out once, and log in again.

When User Authentication or Account Track is not enabled

You are automatically logged in as a public user.

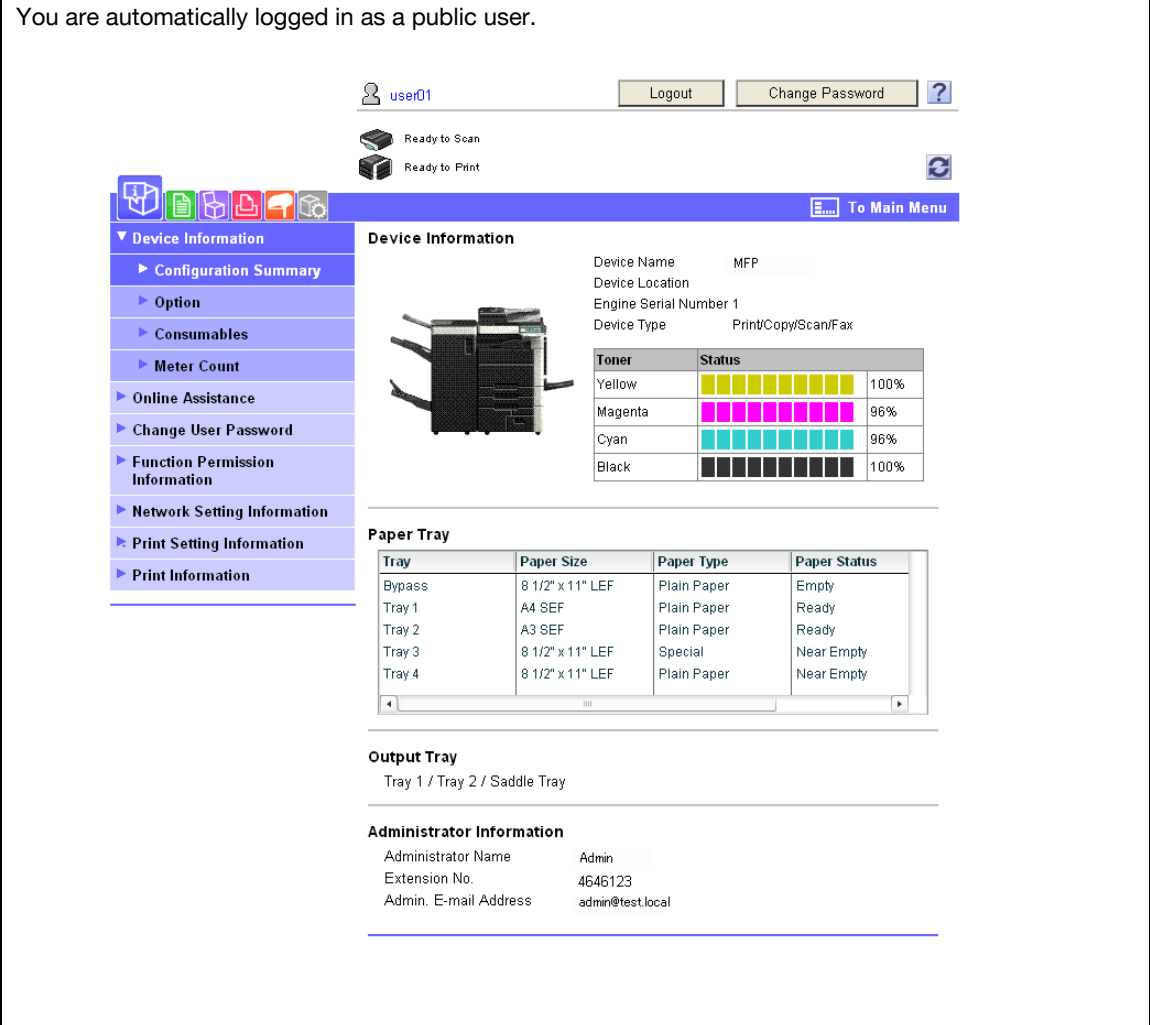

The screenshot shows the following information:

user01 [Logout] [Change Password] [?]

Ready to Scan
Ready to Print

Device Information

Device Name: MFP
Device Location:
Engine Serial Number 1:
Device Type: Print/Copy/Scan/Fax

Toner	Status	Percentage
Yellow	[Progress Bar]	100%
Magenta	[Progress Bar]	96%
Cyan	[Progress Bar]	96%
Black	[Progress Bar]	100%

Paper Tray

Tray	Paper Size	Paper Type	Paper Status
Bypass	8 1/2" x 11" LEF	Plain Paper	Empty
Tray 1	A4 SEF	Plain Paper	Ready
Tray 2	A3 SEF	Plain Paper	Ready
Tray 3	8 1/2" x 11" LEF	Special	Near Empty
Tray 4	8 1/2" x 11" LEF	Plain Paper	Near Empty



Output Tray
Tray 1 / Tray 2 / Saddle Tray

Administrator Information

Administrator Name: Admin
Extension No.: 4646123
Admin. E-mail Address: admin@test.local

To log in as an administrator, log out once.

Login as an administrator again.



Web Connection

Language

Login Public User

Administrator

View Mode Flash HTML

Flash Player is necessary to see in Flash form. 

User Assist Display dialog box in case of warning.

Starting-up Data Management Utility
Flash Player is required to use the Data Management Utility.

- [Manage Copy Protect Data](#)
- [Manage Stamp Data](#)
- [Manage Font/Macro \(*1\)](#)

(*1) Can only run on Windows Internet Explorer and Flash Player Version 9 and above environments.

When User Authentication or Account Track is enabled

If **PageScope Authentication Manager** is used for authentication, ask your server administrator about the login procedure.

The User Authentication or Account Track page appears. Enter the required items to log in.

Language OS Language (OS Language) ▾

Login Public User

Registered User

User Name

Password

Administrator

View Mode Flash HTML

Flash Player is necessary to see in Flash form.

User Assist Display dialog box in case of warning.

Starting-up Data Management Utility

Flash Player is required to use the Data Management Utility.

[Manage Copy Protect Data](#)

[Manage Stamp Data](#)

[Manage Font/Macro \(*1\)](#)

(*1) Can only run on Windows Internet Explorer and Flash Player Version 9 and above environments.



To log in as a different user or as an administrator, log out once.



Log in again.

9.2.2 Logout

Click [Logout] or [To Login Screen] at the upper right of the window. A logout confirmation page appears. Click [OK] to return to the login page.

Reference

- The login page that appears differs depending on whether Authentication is enabled in this machine.
- When logged in as a public user, [To Login Screen] appears. When logged in as a registered user or an administrator, [Logout] appears.
- If timeout occurred because no operation was performed for the specified period during login or if authentication setting was changed using the control panel while logging in to the user mode, you will automatically log out of the mode.
- For details on how to specify the timeout period of the user or administrator modes, refer to page 9-39.

9.2.3 Login

PageScope Web Connection provides the user or administrator mode depending on how to log in. If necessary, you can log in to the user mode as an administrator or User Box administrator depending on user authentication or User Box administrator setting.

Reference

- You can log in as a User Box administrator when the User Box administrator is enabled using the control panel. For details on the User Box administrator setting, permissions, and password, refer to the page 8-26.
- Logging in to the user mode as an administrator enables you to perform job deletion processing, which is not available in the administrator.
- In the login page, select the desired Data Management Utility. For details on Data Management Utility, refer to the [User's Guide Network Administrator].

Login options

You can select items as required when logging in.

Item	Description
Language	Select the language to display information in.
View Mode	Select Flash or HTML. <ul style="list-style-type: none"> • To use the read-out software, select HTML. • In the IPv6 environment, select HTML. • To select Flash, prepare Flash Player.
User Assist	Select the [Display dialog box in case of warning.] check box to display the dialog box when a warning has occurred or during operation after login.

Reference

- If Flash is selected in View Mode, the following items are displayed using Flash.
 - Status icons and messages
 - Status of [Paper Tray] in [Information] - [Device Information]
 - Status of [Job]

Logging in as a public user

If user authentication is not enabled on the machine, you will be logging in as a public user. In the login page, select [Public User], and click [Login].

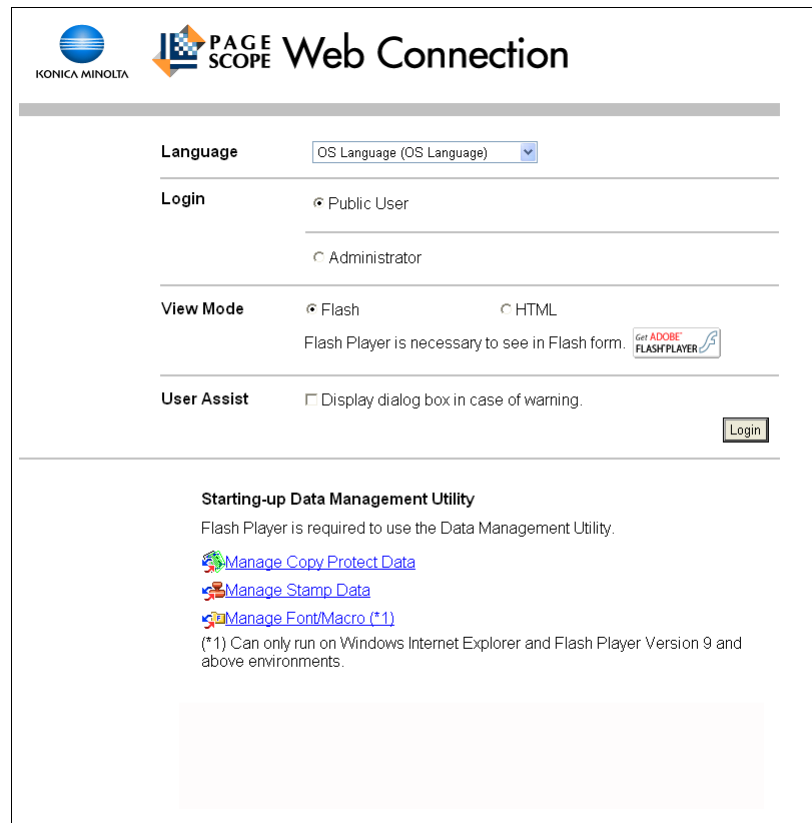

Language OS Language (OS Language) ▾

Login

Public User

Administrator

View Mode Flash HTML

Flash Player is necessary to see in Flash form. 

User Assist Display dialog box in case of warning.

Starting-up Data Management Utility

Flash Player is required to use the Data Management Utility.

[Manage Copy Protect Data](#)

[Manage Stamp Data](#)

[Manage Font/Macro \(*1\)](#)

(*1) Can only run on Windows Internet Explorer and Flash Player Version 9 and above environments.

Logging in as a registered user

Specify the registered user name and password to log in when User Authentication is enabled in this machine.

→ In the login page, enter the user name and the password, and click [Login].

Language OS Language (OS Language) ▾

Login

Public User

Registered User

User Name

Password

Administrator

View Mode Flash HTML

Flash Player is necessary to see in Flash form.

User Assist Display dialog box in case of warning.

Starting-up Data Management Utility

Flash Player is required to use the Data Management Utility.

[Manage Copy Protect Data](#)

[Manage Stamp Data](#)

[Manage Font/Macro \(*1\)](#)

(*1) Can only run on Windows Internet Explorer and Flash Player Version 9 and above environments.

Reference

- If Account Track is enabled, also enter the account name and password.
- To select a user name from a list, click [User List].
- If External Server Authentication is enabled, select a server.
- To log in to the user mode as an administrator, select [Administrator] - [Administrator (User Mode)], and enter the administrator password.
- If a user enters an incorrect password a specified number of times when "Mode 2" is selected in "Prohibited Functions When Authentication Error" in Administrator Settings, the user is locked, and cannot use the control panel. For details on how to disable "Prohibit Functions When Authentication Error", contact your administrator.
- [User List] is available only when User Name List is set to [ON]. For details, refer to the [User's Guide Copy Operations].

Logging in to administrator mode

To configure the system or network setting, log in to the administrator mode.

- 1 Select [Administrator] and click [Login].

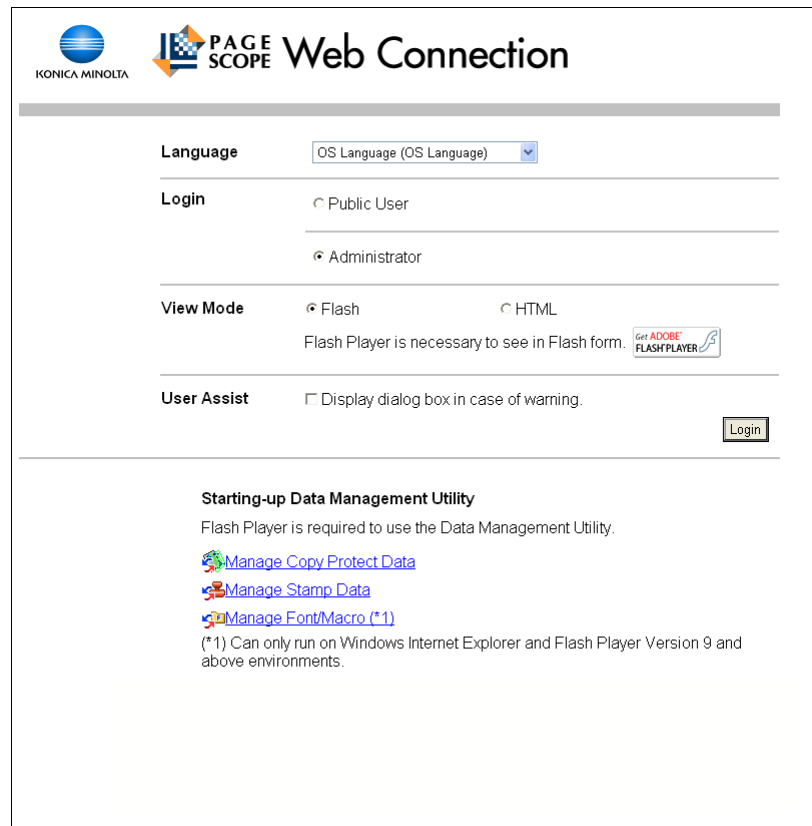

Language OS Language (OS Language) ▾

Login Public User
 Administrator

View Mode Flash HTML
Flash Player is necessary to see in Flash form. 

User Assist Display dialog box in case of warning.

Starting-up Data Management Utility
Flash Player is required to use the Data Management Utility.

[Manage Copy/Protect Data](#)
[Manage Stamp Data](#)
[Manage Font/Macro \(*1\)](#)

(*1) Can only run on Windows Internet Explorer and Flash Player Version 9 and above environments.

- 2 Enter the administrator password in the page that appears, and then click [OK].
 - To log in to the user mode as an administrator, select [Administrator (User Mode)], and enter the administrator password.
 - Logging in to the administrator mode locks the control panel of this machine, and you will not be able to use it.
 - Depending on the status of this machine, you may not be able to log in to the administrator mode.
 - If [Prohibited Functions When Authentication Error] in the Administrator Settings is set to Mode 2 and an incorrect password is entered the specified number of times, it is no longer possible to log in to the administrator mode. For details on the Prohibited Functions When Authentication Error parameter, refer to the [User's Guide Copy Operations].
 - The password entry page varies depending on the machine settings.

- You can display the explanation of functions (Help) when necessary. To display Help, select [ON] in Display Setting.
- [On Mouse]: Point the cursor to display Help.
- [On Focus]: Select an item to display Help.

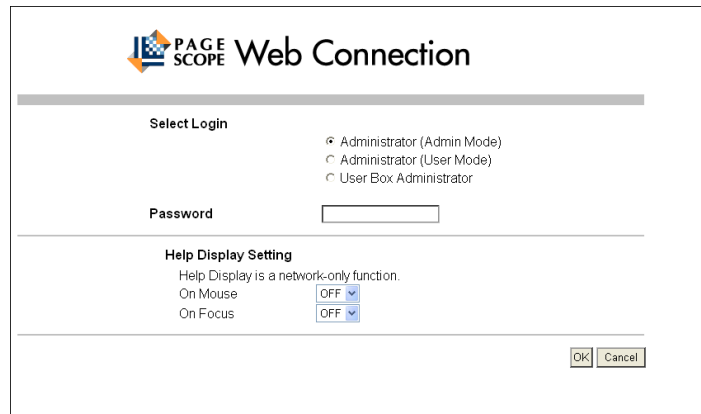

The screenshot shows a web-based interface for 'PAGE SCOPE Web Connection'. It features a 'Select Login' section with three radio button options: 'Administrator (Admin Mode)' (selected), 'Administrator (User Mode)', and 'User Box Administrator'. Below this is a 'Password' field. The 'Help Display Setting' section includes a note that 'Help Display is a network-only function.' and two dropdown menus for 'On Mouse' and 'On Focus', both currently set to 'OFF'. 'OK' and 'Cancel' buttons are located at the bottom right of the dialog.

Display mode in administrator mode

In [System Settings] - [Display Setting], the display mode in the administrator mode can be selected from [Tab Function Display] or [List Function Display]. This manual shows an example where the [List Function Display] is set as the display mode.

In either display mode, the available items are the same.

In the default setting, the screen is displayed in [Tab Function Display].

In [Tab Function Display], click the desired icon to change the menu.

Administrator Logout ?

Ready to Scan
Ready to Print

Meter Count
ROM Version
Import/Export
Status Notification Setting
Total Counter Notification Setting
Date/Time Setting
Timer Setting
Network Error Code Display Setting
Reset
License Settings
Edit Font/Macro
Job Log

Total Counter

Total	1
Total Duplex	0
# of Originals	1
# of Used Paper	1

Copy Counter

	Full Color	Black	Single Color	2 Color	Total
Total	0	1	0	0	1
Large Size	0	0	0	0	0

Print Counter

	Full Color	Black	2 Color	Total
Total	0	0	0	0
Large Size	0	0	0	0

Scan / Fax Counter

	Print (Full Color)	Print (Black)	Scans
Total	0	0	14
Large Size	0	0	0

Fax TX: 1
Fax RX: 0

Total (Copy + Print)

	Full Color	Black	2 Color
Total	0	1	0

Paper Size / Type Counter

Paper Size	Paper Type	Count
11" x 17"	Not Specified	0
8 1/2" x 14"	Not Specified	0
8 1/2" x 11"	Not Specified	0
5 1/2" x 8 1/2"	Not Specified	0
A3	Not Specified	0
B4	Not Specified	0
B5	Not Specified	0
A4	Not Specified	0
A5	Not Specified	0
Others	Not Specified	0

In [List Function Display], change the menu from the list box.

Select the desired menu in the drop-down list, click [Display].

Administrator Logout ?

Ready to Scan
In Menu (Admin Mode)

Maintenance Display To Main Menu

Meter Count
ROM Version
Import/Export
Status Notification Setting
Total Counter Notification Setting
Date/Time Setting
Timer Setting
Network Error Code Display Setting
Reset
License Settings
Edit Font/Macro
Job Log

Total Counter

Total	137
Total Duplex	12
# of Originals	143
# of Used Paper	106

Copy Counter

	Full Color	Black	Single Color	2 Color	Total
Total	39	55	0	0	94
Large Size	4	0	0	0	4

Print Counter

	Full Color	Black	2 Color	Total
Total	22	5	3	30
Large Size	0	0	0	0

Scan / Fax Counter

	Print (Full Color)	Print (Black)	Scans
Total	0	13	54
Large Size	0	0	0

Fax TX: 0
Fax RX: 0

Total (Copy + Print)

	Full Color	Black	2 Color
Total	61	60	3

Paper Size / Type Counter

Paper Size	Paper Type	Count
11" x 17"	Not Specified	0
8 1/2" x 14"	Not Specified	0
8 1/2" x 11"	Not Specified	0
5 1/2" x 8 1/2"	Not Specified	0
A3	Not Specified	0
B4	Not Specified	0
B5	Not Specified	0
A4	Not Specified	1
A5	Not Specified	0
Others	Not Specified	0

Logging in as a User Box administrator

You can log in to the user mode as an administrator to delete a job when User Authentication is enabled in this machine. If necessary, you can log in to the user mode as a User Box administrator when the User Box administrator is enabled using the control panel.

- In the login page, select [Administrator] and click [Login].
- To log in to the user mode as a User Box administrator, select [User Box Administrator], and enter the User Box administrator's password.

The screenshot shows a web-based login interface for a device. At the top left is the 'PAGE SCOPE' logo. The main title is 'Web Connection'. Below this is a horizontal separator line. The first section is 'Select Login', which contains three radio button options: 'Administrator (Admin Mode)', 'Administrator (User Mode)', and 'User Box Administrator'. The second section is 'Password', which contains a single text input field. The third section is 'Help Display Setting', which includes the text 'Help Display is a network-only function.' followed by two settings: 'On Mouse' and 'On Focus', each with a dropdown menu currently set to 'OFF'. At the bottom right of the dialog are two buttons: 'OK' and 'Cancel'.

Reference

- To log in to the user mode as an administrator, select [Administrator] - [Administrator (User Mode)], and enter the administrator password.
- If [Prohibited Functions When Authentication Error] in the Administrator Settings is set to Mode 2 and an incorrect password is entered the specified number of times, it is no longer possible to log in to the administrator mode. For details on the Prohibited Functions When Authentication Error parameter, refer to the [User's Guide Copy Operations].
- The password entry page varies depending on the machine settings.
- You can display the explanation of functions (Help) when necessary. To display Help, select [ON] in Display Setting.
 - [On Mouse]: Point the cursor to display Help.
 - [On Focus]: Select an item to display Help.

9.3 Page Configuration

Clicking an item in the top menu after logging in to **PageScope Web Connection** shows the linked information in the following configuration. This example shows the items in Information - Device Information.

Reference

- The contents of the **PageScope Web Connection** pages vary depending on the options installed in this machine or the settings of this machine.

1 — KONICA MINOLTA

2 — PAGE SCOPE Web Connection

Model Name: bizhub C652

3 — user01

4 — Ready to Scan

5 — Ready to Print

6 — Logout

7 — Change Password

8 — ?

9 — To Main Menu

10 — Device Information

11 — Configuration Summary

Option

Consumables

Meter Count

Online Assistance

Change User Password

Function Permission Information

Network Setting Information

Print Setting Information

Print Information

Device Information

Device Name MFP

Device Location

Engine Serial Number 1

Device Type Print/Copy/Scan/Fax

Toner	Status	Percentage
Yellow		100%
Magenta		96%
Cyan		96%
Black		100%

Paper Tray

Tray	Paper Size	Paper Type	Paper Status
Bypass	8 1/2" x 11" LEF	Plain Paper	Empty
Tray 1	A4 SEF	Plain Paper	Ready
Tray 2	A3 SEF	Plain Paper	Ready
Tray 3	8 1/2" x 11" LEF	Special	Near Empty
Tray 4	8 1/2" x 11" LEF	Plain Paper	Near Empty

Output Tray

Tray 1 / Tray 2 / Saddle Tray

Administrator Information

Administrator Name Admin

Extension No. 4646123

Admin. E-mail Address admin@test.local

12

No.	Item	Description
1	KONICA MINOLTA logo	Click this logo to jump to the Konica Minolta Web site at the following URL. http://www.konicaminolta.com/
2	PageScope Web Connection logo	Click this logo to display the version information of PageScope Web Connection .
3	Login user name	Displays the current login mode icon and user name (public, administrator, User Box administrator, registered user, or account). Click the user name to display the login user name.
4	Status display	Displays the status of the printer and scanner sections of this machine with icons and messages. Clicking the desired icon when an error occurs displays the information (Consumable Info, Paper Tray, or user registration page) associated with the icon to enable you to check the status.
5	Message display	Displays the operating status of this machine.

No.	Item	Description
6	[To Login Screen]/ [Logout]	Click this button to log out the current mode and log in again. When logged in as a public user, [To Login Screen] appears. When logged in as a registered user or an administrator, [Logout] appears.
7	[Change Password]	Click this button to jump to the user password change page. This button appears only in the user mode page in which you logged in as a registered user.
8	Help	You can display the online help for the currently configured function. For the specified pages, refer to "Online Assistance" in page 9-18.
9	Refresh	Click this icon to refresh the information displayed in the page.
10	Icon	<p>Select the category of the item to be displayed. The following icons are displayed in the user mode.</p> <ul style="list-style-type: none"> • Information • Job • User Boxes • Direct Print • Store Address • Customize
11	Menu	Displays information and setting for the selected icon. The menu that appears in this area varies depending on which icon was selected.
12	Information and settings	Displays the details of the item selected in the menu.

9.4 User Mode Overview

Logging in to the user mode enables you to configure the following functions.

9.4.1 Information



Reference

You can also check the explanation of the user mode in the **PageScope Web Connection** online help or **PageScope Web Connection** manual included in the application DVD-ROM. For details on the online help, refer to page 9-4.

The screenshot displays the user interface for a printer's web management system. At the top, the user is logged in as 'user01' with options for 'Logout' and 'Change Password'. Below this, there are status indicators for 'Ready to Scan' and 'Ready to Print'. A navigation menu on the left lists various settings categories, with 'Device Information' selected. The main content area shows 'Device Information' for an MFP, including its name, location, engine serial number, and type. A toner status table shows levels for Yellow, Magenta, Cyan, and Black. Below that, the 'Paper Tray' table lists four trays with their respective paper sizes and types. The 'Output Tray' section shows the current tray configuration. Finally, 'Administrator Information' is displayed at the bottom, including the administrator's name, extension number, and email address.

Toner	Status	Level
Yellow		100%
Magenta		96%
Cyan		96%
Black		100%

Tray	Paper Size	Paper Type	Paper Status
Bypass	8 1/2" x 11" LEF	Plain Paper	Empty
Tray 1	A4 SEF	Plain Paper	Ready
Tray 2	A3 SEF	Plain Paper	Ready
Tray 3	8 1/2" x 11" LEF	Special	Near Empty
Tray 4	8 1/2" x 11" LEF	Plain Paper	Near Empty

Administrator Information	Value
Administrator Name	Admin
Extension No.	4646123
Admin. E-mail Address	admin@test.local

Item	Description
[Device Information]	Enables you to check the components, options, consumables, and meter counts of this machine.
[Online Assistance]	Enables you to check the online assistance about this product.
[Change User Password]	Changes the password of the login user.
[Function Permission Information]	Enables you to check the function permission information about the user or account.
[Network Setting Information]	Enables you to check the network settings of this machine.
[Print Setting Information]	Enables you to check the printer controller settings of this machine.
[Print Information]	Prints font or configuration information.

9.4.2 Job

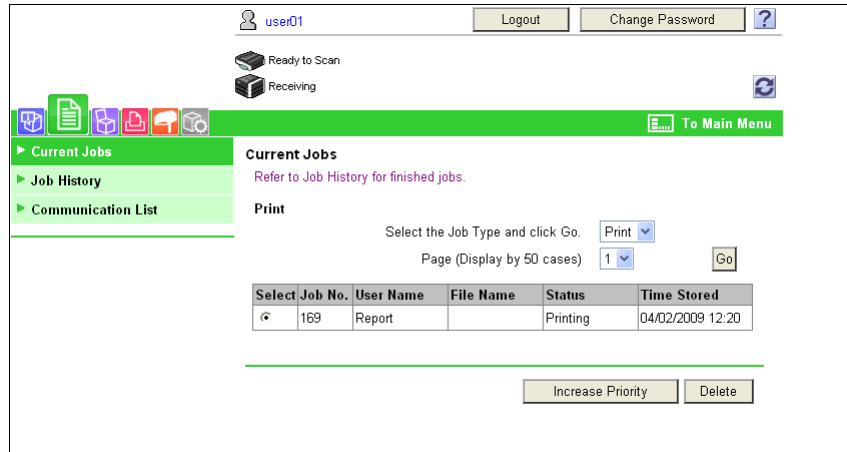

Item	Description
[Current Jobs]	Enables you to check the currently executed job or queued jobs.
[Job History]	Enables you to check the executed jobs.
[Communication List]	Enables you to check the completed transmission and reception jobs.

9.4.3 User Boxes



Reference

For details on how to handle User Boxes, refer to page 9-23.

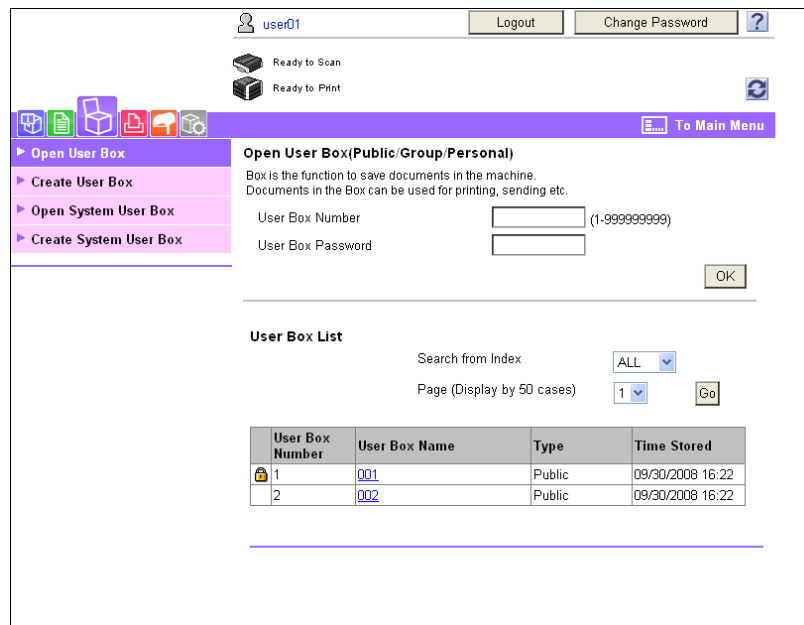

Item	Description
[Open User Box]	Opens the currently created User Box (Public, Personal, or Group User Box) to enable you to print, send, or download a document saved in the User Box or to change the User Box setting.
[Create User Box]	Enables to create a new User Box.

Item	Description
[Open System User Box]	Displayed when the optional Fax Kit is installed. This function opens the System User Box (Bulletin Board, Polling TX, Memory RX, or Relay User Box) to enable you to handle a document saved in the User Box or change the User Box setting.
[Create System User Box]	Displayed when the optional Fax Kit is installed. This function enables you to create a new Bulletin Board or Relay User Box.

9.4.4 Direct Print

Item	Description
[Direct Print]	Specify a file saved in the computer to print it using this machine. If necessary, you can select [Application Setting] to save a document in the specified User Box.

Reference

- [Direct Print] may not be displayed depending on settings in the administrator mode.

9.4.5 Store Address

[Store Address] may not be displayed depending on settings in the administrator mode.

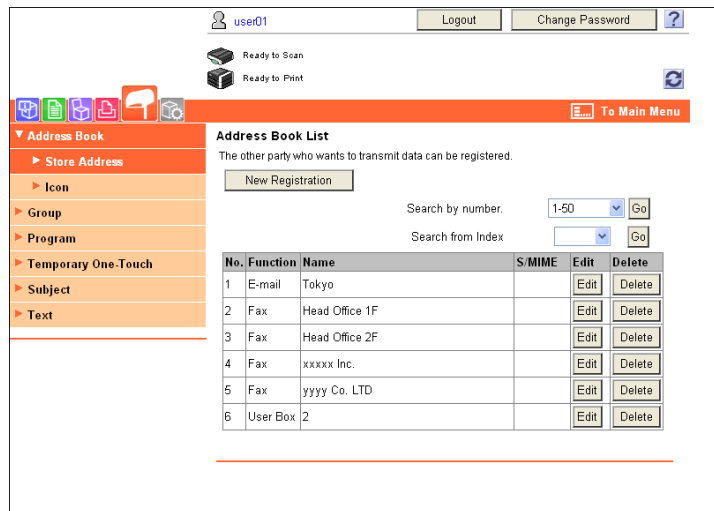

Item	Description
[Address Book]	Enables you to check the address book registered in this machine or to register and change an address.
[Group]	Enables you to check the group address book registered in this machine or to register and change an address.
[Program]	Enables you to check the program address book registered in this machine or to register and change an address.
[Temporary One-Touch]	Enables you to check the temporary program address book registered in this machine or to register and change an address.
[Subject]	Enables you to register or change up to 10 subjects when sending E-mails.
[Text]	Enables you to register or change up to 10 body messages when sending E-mails.

9.4.6 Customize

Enables you to specify the initial page after logging in.

The screenshot displays the 'Option' configuration page. At the top, there is a user profile for 'user01' with 'Logout' and 'Change Password' buttons. Below this, there are status indicators for 'Ready to Scan' and 'Ready to Print'. A navigation bar contains icons for various functions and a 'To Main Menu' button. The main content area is titled 'Option' and includes a note: 'The following settings will be saved in Cookie. If Cookie is deleted, the default screen will become the Device Information screen.' Under 'Initial Screen after login', the 'Main Menu' radio button is selected. Other options include 'Information', 'Job', 'Box', 'Direct Print', 'Store Address', and 'Customize'. To the right, there are several dropdown menus: 'Device Information', 'Current Jobs', 'Open User Box', 'Registered Box Number' (with a placeholder '(1-99999999)'), 'Direct Print', 'Address Book', and 'Option'. A 'Search from List' button is located below the 'Open User Box' dropdown. At the bottom right, there are 'OK' and 'Cancel' buttons.

Item	Description
[Option]	Enables you to configure the settings displayed in the initial page after logging in to this machine.

9.5 Handling a document in a User Box

The [Open User Box] menu supports the following functions.

- Listing the documents saved in a User Box
- Printing a document
- Sending a document to another machine
- Downloading and saving document data in your computer
- Moving or copying a document to another User Box
- Deleting a document

9.5.1 Listing the documents saved in a User Box

Logging in displays a list of the User Boxes (Public, Personal, and Group User Boxes) created in the accessed MFP.

Open User Box

Select the target User Box name in the User Box list. Otherwise, enter the User Box number and password, and click [OK].

Reference

- Selecting a User Box name with a password displays the password entry page.

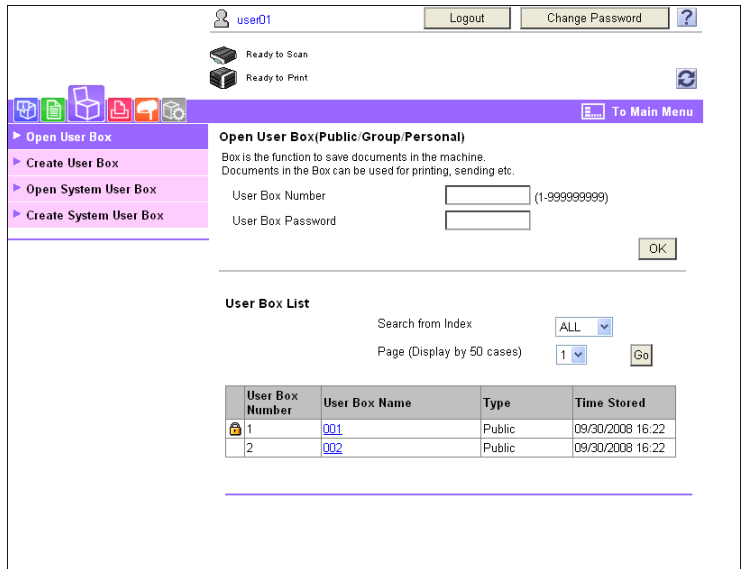

<Open User Box (Public, Group, or Personal User Box)>

"Open User Box" is displayed as shown below depending on the User Authentication or Account Track settings.

- [Open User Box(Public)]: Displayed when User Authentication is not enabled.
- [Open User Box(Public/Personal)]: Displayed when User Authentication is enabled.
- [Open User Box(Public/Group)]: Displayed when Account Track is enabled.
- [Open User Box(Public/Group/Personal)]: Displayed when User Authentication and Account Track are enabled.

Item	Description
[User Box Number]	Enter the number of the User Box to be opened.
[User Box Password]	If a password is set to the target User Box, enter the password.

<User Box List>

Item	Description
[Search from Index]	Displays a list of User Boxes for each index, which was selected when creating a User Box.
[Page (Display by 50 cases)]	When this machine contains 50 or more User Boxes, specify the desired page to change the display.
[User Box List]	Displays the User Box number, User Box name, User Box type, and creation date and time. A User Box with a password is displayed by a key-shaped icon.

File List

Selecting a User Box displays its basic information and also lists the documents saved in the User Box.



Item	Description
[User Box Settings]	Click this button to change the User Box name, index, extension, or password setting.
[Delete User Box]	Click this button to delete the displayed User Box. <ul style="list-style-type: none"> Deleting a User Box erases all the documents saved in the User Box.
Thumbnail View	To view a thumbnail image for each document, click [ON]. When you do not view thumbnail images, click [OFF].
Specify operation	Select the target operation, for example, printing, moving, copying, or deleting a document, sending to another machine, or downloading to your computer. For details, refer to page 9-25.
[Changes the display]	Select the target operation, and click this button to display the "Select" check box for the document that can be handled by the target function.
Select	Displays a check box for the document that can be handled by the selected function.
Thumbnail	Displays the image of the first page when the thumbnail image display function is enabled.

Item	Description
Document Name	Displays a document name.
Number of Originals	Displays the number of originals in a document.
[Edit Name]	Click this button to rename a document.

Reference

- If 11 or more documents are saved, [Page (Display by 10 cases)] is displayed.

9.5.2 Printing a document

- 1 Select [Specify operation] - [Print], and click [Changes the display].



The select check box is displayed for printable documents.

- 2 Select the check box of the target document, and click [Print Setting].

user01 Logout Change Password ?

Ready to Scan
Ready to Print

To Main Menu

Open User Box
Create User Box
Open System User Box
Create System User Box

User Box Number 2 User Box Name box02
Type Public Owner Name Public
Box Operation User Box Setting Delete User Box

File List Thumbnail View OFF

First, select an operation. The selectable documents are displayed.

Specify operation Print Changes the display

Select	Thumbnail	Document Name	Number of Originals	Edit Name
<input checked="" type="checkbox"/>		photo1	1	Edit Name
<input checked="" type="checkbox"/>		document1	1	Edit Name
<input checked="" type="checkbox"/>		photo3	1	Edit Name
<input checked="" type="checkbox"/>		photo4	1	Edit Name

Select document and execute.

Print Setting Cancel

- 3 Configure print settings.

user01 Logout Change Password ?

Ready to Scan
Ready to Print

To Main Menu

Open User Box
Open System User Box

Print
Press OK to print.
Settings can be changed below.

Change order

[1] photo1
[2] document1
[3] photo3
[4] photo4

Top
Up
Down
Bottom
Undo

Thumbnail View

Combine OFF
(Max. 10 documents can be combined and printed as 1 document.)

Basic Setting

Number of Sets 1 (1-999)
2-Sided Print OFF
Continuous Print OFF
Color Use Existing Color Setting

Finishing

Offset OFF
Staple OFF
Punch OFF
Binding Position Auto
Fold OFF

Zoom

Existing Setting
Fixed Zoom 200.0 %
Zoom Magnification 400.0 % (25.0 - 400.0)
User Preset Zoom 400.0 %
Minimal

Combine Existing Setting
Combine Direction Horizontal

Application Setting Display

OK Cancel

Item	Description
[Change order]	Displayed when multiple documents are selected. This function enables you to change the printing order. Click the target document, and select [Top], [Up], [Down], [Bottom], or [Undo]. When checking a thumbnail image for each document, click [Thumbnail View].
[Combine]	Displayed when multiple documents are selected. This function prints the selected documents as one.
[Basic Setting]	Configure the number of sets, 2-sided printing, color, and finishing settings.
[Application Setting]	Configure more detailed setting such as Page Margin or Stamp. When using this function, click [Display].
[Save Print Settings]	Select whether to save print setting.

- If multiple documents are selected while Combine is set to [OFF], Basic Setting and Application Setting will become unavailable.
- [Save Print Settings] is not displayed when multiple documents are selected.

4 Click [OK].

Printing starts.

5 Click [OK].

You then return to the File List page.

9.5.3 Sending a document to another machine

- 1 Select [Specify operation] - [Send to other device], and click [Changes the display].

The screenshot shows a user interface for a document management system. At the top, there is a user profile for 'user01' with 'Logout' and 'Change Password' buttons. Below this, there are status indicators for 'Ready to Scan' and 'Ready to Print'. A navigation bar contains icons for home, documents, and settings, along with a 'To Main Menu' button. A sidebar on the left lists options: 'Open User Box', 'Create User Box', 'Open System User Box', and 'Create System User Box'. The main content area displays 'User Box Number 2' and 'User Box Name box02'. It also shows 'Type Public' and 'Owner Name Public'. There are buttons for 'User Box Setting' and 'Delete User Box'. Below this is the 'File List' section, which has a 'Thumbnail View' toggle set to 'OFF'. A message says 'First, select an operation. The selectable documents are displayed.' There is a 'Specify operation' dropdown menu currently set to 'Display All', and a 'Changes the display' button. A table lists documents with columns for 'Select', 'Thumbnail', 'Number of Originals', and 'Edit Name'. The first document has a context menu open over its thumbnail, with 'Send to other device' highlighted. The other documents are 'document1', 'photo3', and 'photo4'. A 'Cancel' button is at the bottom right.

Select	Thumbnail	Number of Originals	Edit Name
<input type="checkbox"/>		1	Edit Name
<input type="checkbox"/>		1	Edit Name
<input type="checkbox"/>		1	Edit Name
<input type="checkbox"/>		1	Edit Name

The select check box is displayed for documents that can be sent.

2 Select the check box of the target document, and click [TX Setting].

The screenshot displays a web-based interface for document management. At the top, the user is identified as 'user01' with options for 'Logout' and 'Change Password'. Below this, there are status indicators for 'Ready to Scan' and 'Ready to Print'. A navigation bar on the left includes options like 'Open User Box', 'Create User Box', 'Open System User Box', and 'Create System User Box'. The main area shows user box details: 'User Box Number 2', 'User Box Name box02', 'Type Public', and 'Owner Name Public'. There are buttons for 'User Box Setting' and 'Delete User Box'. The 'File List' section includes a 'Thumbnail View' toggle set to 'OFF' and a 'Specify operation' dropdown menu set to 'Send to other device'. A table lists documents with columns for 'Select', 'Thumbnail', 'Document Name', 'Number of Originals', and 'Edit Name'. The table contains four rows: 'photo1', 'document1', 'photo3', and 'photo4'. The 'document1' and 'photo4' rows have checkmarks in the 'Select' column. Below the table, there is a 'TX Setting' button and a 'Cancel' button.

Select	Thumbnail	Document Name	Number of Originals	Edit Name
<input type="checkbox"/>		photo1	1	Edit Name
<input checked="" type="checkbox"/>		document1	1	Edit Name
<input type="checkbox"/>		photo3	1	Edit Name
<input checked="" type="checkbox"/>		photo4	1	Edit Name

3 Configure send settings.

user01 Logout Change Password ?

Ready to Scan
Ready to Print

To Main Menu

Open User Box
Create User Box
Open System User Box
Create System User Box

Send to other device
Specify the destination and click the OK button.
Settings can be changed below.

Specify destination
Search from List
Registered Abbreviated address number
TotalID
Check Destination

Change order
[1] document1
[2] photo3
Top
Up
Down
Bottom
Undo
Thumbnail View

Bind TX OFF
(Max. 10 documents can be combined and sent as 1 document.)

File Type
File Type PDF
Outline PDF OFF
Page Setting
Multi Page
Page Separation 1 (1 - 999)
Resolution Existing Setting
Color Use Existing Color Setting

Encryption
Encrypt
Encryption Target Entire Document
Password required to open document
Password
Retype Password
Use a password to restrict document printing and editing and access to document security settings
Password
Retype Password

Detail Setting
Printing Allowed Restrict
Enable copying of text, images and other content Restrict
Changes Allowed
None
Page layout, filling in form fields and signing.
Commenting, filling in form fields and signing.
Any except extracting pages
Inserting, deleting and rotating pages
Filling in form fields and signing.

Stamp Combine Method Image

Communication Setting
Display

Application Setting
Display

OK Cancel

Item

Description

[Specify destination]

Click [Search from List] to select the destination in the address book. When checking the destination list, click [Check Destination].

Item	Description
[Change order]	Displayed when multiple documents are selected. This function enables you to change the sending order. Click the target document, and select [Top], [Up], [Down], [Bottom], or [Undo]. When checking a thumbnail image for each document, click [Thumbnail View].
[Bind TX]	Displayed when multiple documents are selected. This function sends the selected documents as one.
[File Type]	Specify the file type and encryption contents for a file to be sent.
[Communication Setting]	Configure E-mail settings or specify the URL notification destination. When using this function, click [Display].
[Application Setting]	Configure more detailed setting such as Stamp or Send & Print. When using this function, click [Display].

→ If multiple documents are selected while Combine is set to [OFF], File Type, Communication Settings, or Application Setting will become unavailable.

- 4 Click [OK].
Sending starts.
- 5 Click [OK].
You then return to the File List page.

9.5.4 Downloading document data to your computer

- 1 Select [Specify operation] - [Download to PC], and click [Changes the display].

The screenshot shows a user interface for a document management system. At the top, there is a user profile for 'user01' with 'Logout' and 'Change Password' buttons. Below this, there are status indicators for 'Ready to Scan' and 'Ready to Print'. A navigation bar contains icons for various functions and a 'To Main Menu' button. A sidebar on the left lists options: 'Open User Box', 'Create User Box', 'Open System User Box', and 'Create System User Box'. The main content area displays 'User Box Number 2', 'User Box Name box02', 'Type Public', and 'Owner Name Public'. There are buttons for 'User Box Setting' and 'Delete User Box'. The 'File List' section has a 'Thumbnail View' toggle set to 'OFF'. A message says 'First, select an operation. The selectable documents are displayed.' Below this, a 'Specify operation' dropdown menu is open, showing options: 'Display All', 'Print', 'Send to other device', 'Download to PC' (selected), 'Move/Copy', and 'Delete'. A 'Changes the display' button is next to it. The 'File List' table has columns for 'Select Thumbnail', 'Thumbnail', 'Name', 'Number of Originals', and 'Edit Name'. The table contains four rows of documents. The first row has a checked 'Select Thumbnail' checkbox and a thumbnail image. The other rows have unchecked checkboxes and thumbnails. A 'Cancel' button is at the bottom right.

Select Thumbnail	Thumbnail	Name	Number of Originals	Edit Name
<input checked="" type="checkbox"/>			1	Edit Name
<input type="checkbox"/>		document1	1	Edit Name
<input type="checkbox"/>		photo3	1	Edit Name
<input type="checkbox"/>		photo4	1	Edit Name

The select check box is displayed for available documents.

- 2 Select the check box of the target document, and click [Download Setting].

user01 Logout Change Password ?

Ready to Scan
Ready to Print

To Main Menu

Open User Box
Create User Box
Open System User Box
Create System User Box

User Box Number 2 User Box Name box02
Type Public Owner Name Public
Box Operation User Box Setting Delete User Box

File List Thumbnail View OFF

First, select an operation. The selectable documents are displayed.

Specify operation Download to PC Changes the display

Select	Thumbnail	Document Name	Number of Originals	Edit Name
<input type="checkbox"/>		photo1	1	Edit Name
<input checked="" type="checkbox"/>		document1	1	Edit Name
<input checked="" type="checkbox"/>		photo3	1	Edit Name
<input checked="" type="checkbox"/>		photo4	1	Edit Name

Select document and execute.

Download Setting Cancel

- 3 Configure settings.

user01 Logout Change Password ?

Ready to Scan
Ready to Print

To Main Menu

Open User Box
Create User Box
Open System User Box
Create System User Box

Download to PC
Press OK to print.
Settings can be changed below.
If you select two or more documents, they will be combined.

Change order

[1] document1
[2] photo3
[3] photo4

Top
Up
Down
Bottom
Undo

Thumbnail View

Delete File after Downloading Document Save

Set
Number of Originals 3
Color Type
File Format PDF
Outline PDF OFF
Page Range
ALL
Page

OK Cancel

Item	Description
[Change order]	Displayed when multiple documents are selected. This function collects pages in the order in which they are displayed, and prints them as one document. If necessary, you can change that order. Click the target document, and select [Top], [Up], [Down], [Bottom], or [Undo]. When checking a thumbnail image for each document, click [Thumbnail View].
[File Format]	Select the file type for the file to be saved.
[Page Range]	Download all pages or specify the range of successive pages.

- 4 Click [OK].
- 5 When [Preparation for download has been completed] has appeared, click [Download].
The File Download page appears.
- 6 Click [Save].

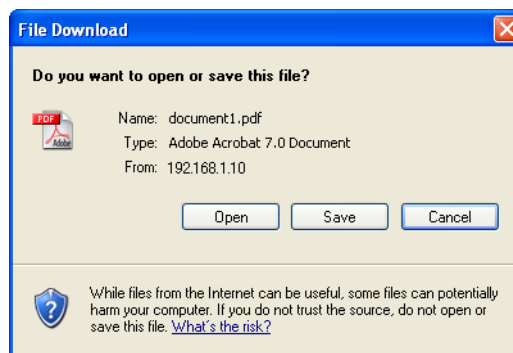

- 7 Specify the saving place and file name, and click [Save].

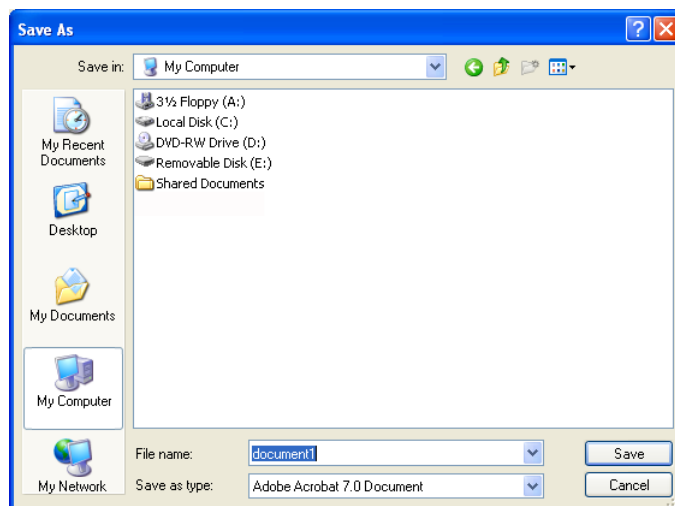

- 8 Click [Back].
You then return to the File List page.

9.5.5 Moving or copying a document to another User Box

- 1 Select [Specify operation] - [Move/Copy], and click [Changes the display].

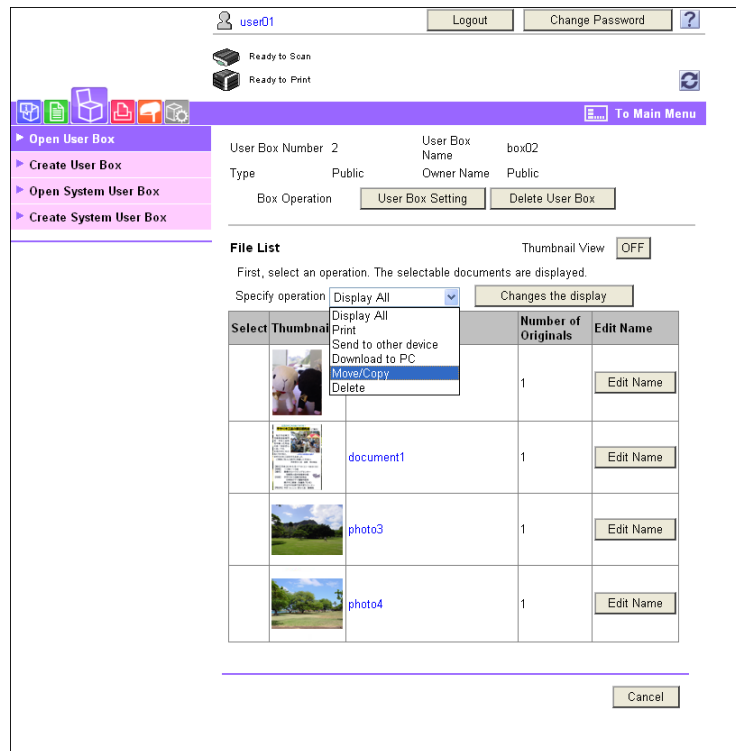

The check box for selecting an available document is displayed.

- 2 Select the check box of the target document, and click [Move/Copy Setting].



→ You cannot select multiple documents.

3 Configure settings.

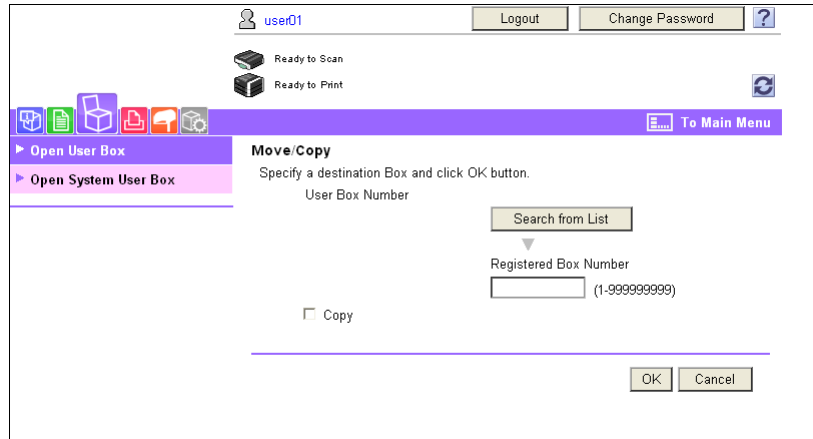

Item	Description
[User Box Number]	Select the User Box to move or copy a document from the User Box List.
[Copy]	Select this check box to copy a document to the target User Box.

- 4 Click [OK].
This moves or copies the document.
- 5 Click [OK].
You then return to the File List page.

9.5.6 Deleting a document

- 1 Select [Specify operation] - [Delete], and click [Changes the display].

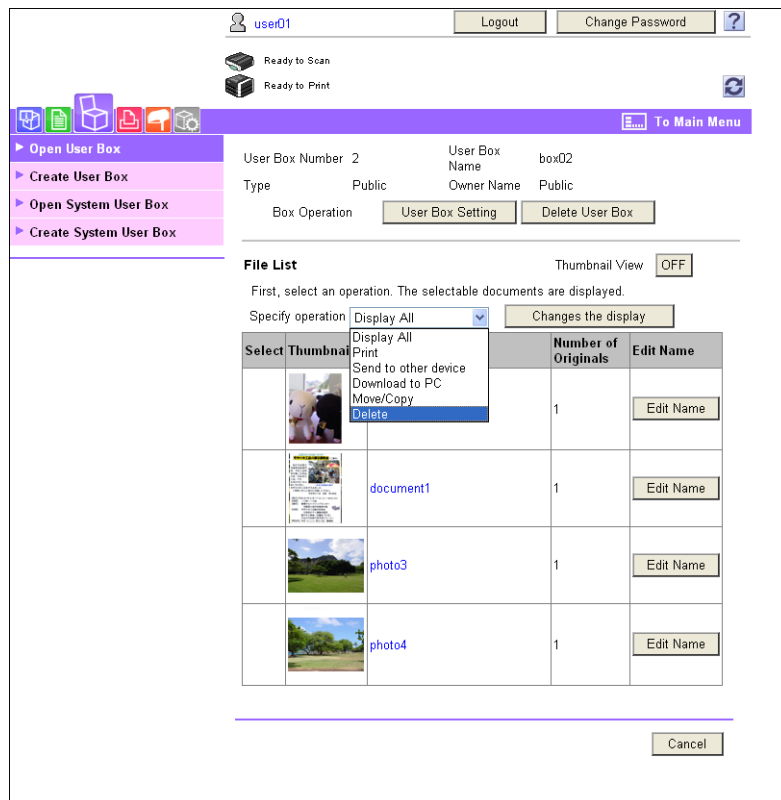

The check box for selecting an available document is displayed.

- 2 Select the check box of the target document, and click [Delete].

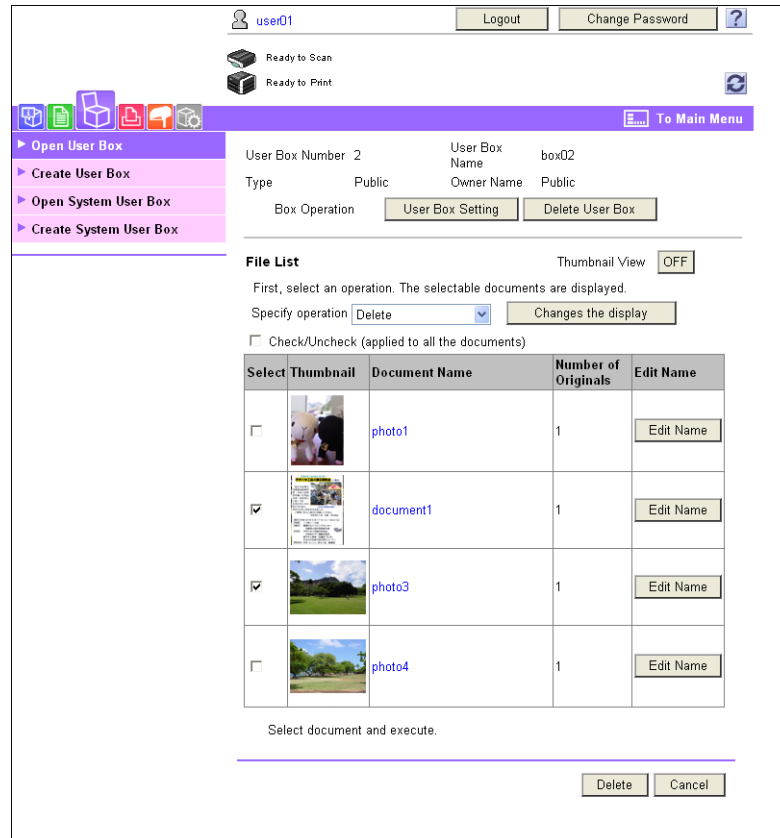

→ To select or unselect all documents, select the [Check/Uncheck] check box.

- 3 Check the document name to be deleted, and click [OK].

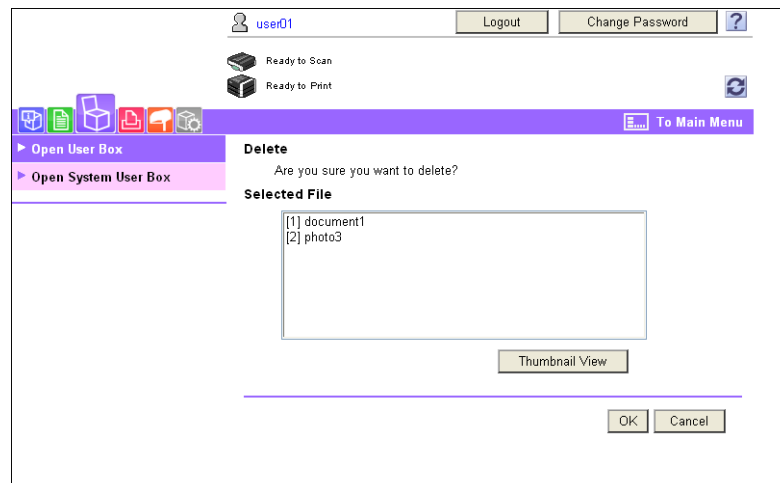

→ When checking a thumbnail image for each document, click [Thumbnail View].

- 4 Click [OK].

This deletes a document(s), and returns you to the File List page.

9.6 Administrator Mode Overview

Logging in to the administrator mode enables you to use the following functions.



Reference

For details on the administrator mode, refer to the [User's Guide Network Administrator].

The administrator modes are classified into two display modes: [Tab Function Display] and [List Function Display]. This manual shows an example where the [List Function Display] is set as the display mode. For details, refer to page 9-14.

9.6.1 Maintenance

The screenshot displays the Administrator Mode interface. At the top, it shows 'Administrator' with a 'Logout' button and a help icon. Below this, there are status indicators: 'Ready to Scan' and 'In Menu (Admin Mode)'. The main menu is titled 'Maintenance' and 'Display', with a 'To Main Menu' button. A sidebar on the left lists various maintenance options: Meter Count, ROM Version, Import/Export, Status Notification Setting, Total Counter Notification Setting, Date/Time Setting, Timer Setting, Network Error Code Display Setting, Reset, License Settings, Edit Font/Macro, and Job Log. The main content area shows several data tables:

Total Counter	
Total	137
Total Duplex	12
# of Originals	143
# of Used Paper	106

Copy Counter					
	Full Color	Black	Single Color	2 Color	Total
Total	39	55	0	0	94
Large Size	4	0	0	0	4

Print Counter				
	Full Color	Black	2 Color	Total
Total	22	5	3	30
Large Size	0	0	0	0

Scan / Fax Counter			
	Print (Full Color)	Print (Black)	Scans
Total	0	13	54
Large Size	0	0	0

Fax TX	0
Fax RX	0

Total (Copy + Print)			
	Full Color	Black	2 Color
Total	61	60	3

Paper Size / Type Counter		
Paper Size	Paper Type	Count
11" x 17"	Not Specified	0
8 1/2" x 14"	Not Specified	0
8 1/2" x 11"	Not Specified	0
5 1/2" x 8 1/2"	Not Specified	0
A3	Not Specified	0
B4	Not Specified	0
B5	Not Specified	0
A4	Not Specified	1
A5	Not Specified	0
Others	Not Specified	0

Item	Description
[Meter Count]	Enables you to check the meter count of this machine.
[ROM Version]	Enables you to check the ROM version.
[Import/Export]	Saves (exports) setting information of this machine as a file, or writes (imports) it from a file to this machine.
[Status Notification Setting]	Configure the function to be reported to a registered user when an error has occurred in this machine. Specify the destination and items to notify a registered user of an error.
[Total Counter Notification Setting]	Configure the setting to notify the target user of the total counter by E-mail, and register the E-mail address of the destination.
[Date/Time Setting]	Specify the date and time displayed in this machine.
[Timer Setting]	Configure Power Save or Weekly Timer Setting in this machine.
[Network Error Code Display Setting]	Specify whether to display the network error code.

Item	Description
[Reset]	Clears all settings for the network, controller and destinations.
[License Settings]	Allows you to issue a license and enable functions. Also, a request code can be issued.
[Edit Font/Macro]	Adds font or macro.
[Job Log]	Allows you to create and download log data of the jobs that were executed in this machine.

9.6.2 System Settings

Reference

- To use this machine as a scanner with the application software under TWAIN, install the dedicated driver software **KONICA MINOLTA TWAIN**. For details, refer to the TWAIN driver manual in the DVD supplied together with this machine.

The screenshot shows the 'System Settings' window in Administrator Mode. The 'Machine Setting' tab is active, displaying a list of settings on the left and their configuration fields on the right. The fields include: Device Location (empty), Administrator Registration (Name: admin, E-mail: admin@123.com, Extension No. (empty)), Input Machine Address (Device Name: MFP, E-mail Address (empty)). There are 'OK' and 'Cancel' buttons at the bottom right.

Item	Description
[Machine Setting]	Changes the registration information of this machine.
[Register Support Information]	Specify support information (such as contact name, corporate URL, or online manual URL) of this machine. To display this information, select [Information] - [Online Assistance].
[Network TWAIN]	Specify the time to release the operation lock when scanning (excluding push-scanning).
[User Box Setting]	Define the User Box functions such as deleting an unnecessary User Box or specifying the document deletion time. If necessary, configure settings to enable saving or reading a document in or from the external memory.
[Stamp Settings]	Register a header or footer.
[Blank Page Print Settings]	Specify whether to print contents configured in [Stamp/Composition] on blank pages.
[Skip Job Operation Settings]	Specify whether to skip a job.
[Flash Display Setting]	Specify whether to allow or restrict the flash display.
[System Connection Setting]	Configure the automatic setting of Prefix/Suffix or the setting for printing data in a cellular phone.
[Display Setting]	Select the display mode in the administrator mode from [Tab Function Display] or [List Function Display].
[Outline PDF Setting]	Specify whether to outline text.

9.6.3 Security

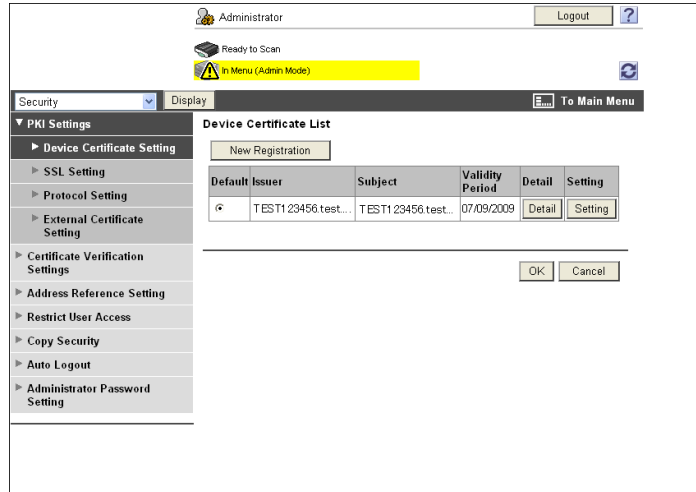

Item	Description
[PKI Settings]	Register device certificates and configure the SSL, protocol, or external certificate settings.
[Certificate Verification Settings]	Specify the items to validate a certificate.
[Address Reference Setting]	When giving destination access permission, specify a reference allowed group name or access allowed level.
[Restrict User Access]	Specify the function to restrict user operations.
[Copy Security]	Specify whether to use the copy guard or password copy function.
[Auto Logout]	Specify the time to automatically log out the administrator or user mode.
[Administrator Password Setting]	Specify the password to log in to the administrator mode.

[Administrator Password Setting] is not displayed when:

- The SSL certificate is not installed
- Enhanced Security Mode is set to "ON"
- [Mode using SSL/TLS] is set to [None] in [Security] - [PKI Settings] - [SSL Setting] even though a device certificate is already registered

9.6.4 User Authentication/Account Track

The screenshot shows the 'User Auth/Account Track' settings window. At the top, there is a user profile for 'Administrator' with a 'Logout' button and a help icon. Below that, there are status indicators for 'Ready to Scan' and 'Ready to Print'. The main content area is titled 'General Settings' and includes a sidebar menu with the following items: User Authentication Setting, Account Track Settings, External Server Settings, Public User Box Setting, User/Account Common Setting, Scan to Home Settings, and Scan to Authorized Folder Settings. The 'General Settings' section contains the following configuration options:

- User Authentication: ON (MFP)
- Public User Access: ON (Without Login)
- Ticket Hold Time Setting (Active Directory): 30 Minute (1-60)
- Account Track: ON
- Account Track Input Method: Account Name & Password
- Synchronize User Authentication & Account Track: Synchronize
- Number of Counters Assigned for Users: 500 (1-999)
- When Number of Jobs Reach Maximum: Skip Job

At the bottom right, there are 'OK' and 'Cancel' buttons.

Item	Description
[General Settings]	Configure the User Authentication or Account Track setting in this machine. To enable authentication, configure the number of assigned counters or the When Number of Jobs Reach Maximum setting.
[User Authentication Setting]	When enabling User Authentication, register the target user or configure user setting.
[Account Track Settings]	When enabling Account Track, register and edit the target account.
[External Server Settings]	When enabling external server authentication, register the external server.
[Public User Box Setting]	Specify the upper limit of the number of User Boxes.
[User/Account Common Setting]	Specify whether to print data in single color or two-color mode.
[Scan to Home Settings]	Configure the setting to send a file to the Home folder.
[Scan to Authorized Folder Settings]	Configure settings to restrict manual TX destinations.

9.6.5 Network

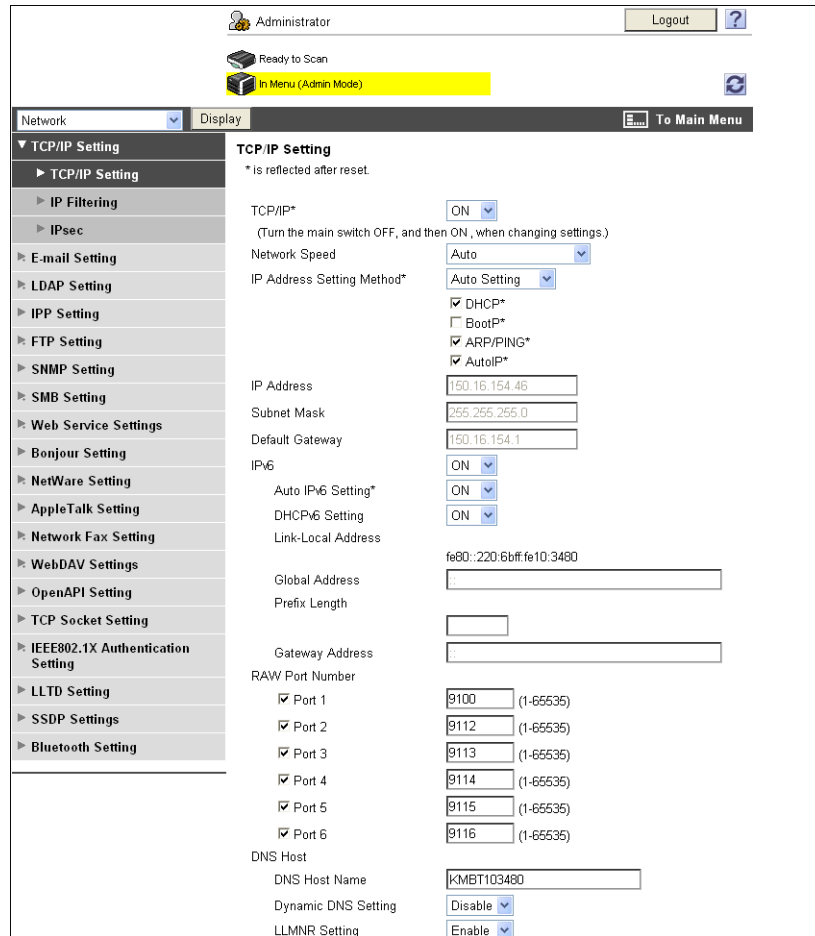

Item	Description
[TCP/IP Setting]	Configure the TCP/IP setting when connecting this machine via network.
[E-mail Setting]	Configure the settings to send or receive E-mails (including Internet fax), and specify the extension function such as E-mail authentication.
[LDAP Setting]	Configure the settings to register the LDAP server.
[IPP Setting]	Configure the IPP print setting.
[FTP Setting]	Configure the settings to use this machine as an FTP client or server.
[SNMP Setting]	Configure SNMP settings.
[SMB Setting]	Configure the SMB client, WINS, or SMB print setting.
[Web Service Settings]	Configure the settings to perform scanning or printing using Web services.
[Bonjour Setting]	Configure Bonjour settings.
[NetWare Setting]	Configure NetWare settings.
[AppleTalk Setting]	Configure AppleTalk settings.
[Network Fax Setting]	Configure the direct SMTP TX or direct SMTP RX settings.
[WebDAV Settings]	Configure the WebDAV settings.
[OpenAPI Setting]	Configure the OpenAPI settings.
[TCP Socket Setting]	Configure the TCP Socket settings to have a data communication between this machine and the application software in your computer.
[IEEE802.1x Authentication Setting]	Configure IEEE802.1X authentication settings.
[LLTD Setting]	Select whether to enable or disable LLTD.

Item	Description
[SSDP Settings]	Configure the SSDP settings.
[Bluetooth Setting]	Select whether to enable or disable Bluetooth. <ul style="list-style-type: none"> To enable a Bluetooth communication, contact your service representative in advance.

9.6.6 User Boxes

Logging in to the administrator mode enables you to handle a User Box without entering the password when opening it.

User Box Number	User Box Name	Type	Time Stored
1	box01	Public	09/30/2008 16:22
2	box02	Public	09/30/2008 16:22
6	box03	Public	10/01/2008 12:56

Item	Description
[Open User Box]	Opens the currently created User Box (Public, Group, or Personal User Box) to enable you to change the User Box setting. <ul style="list-style-type: none"> Document operations are not available in the administrator mode. User Box operations are available even if a password is specified for the target User Box.
[Create User Box]	Enables to create a new User Box.
[Open System User Box]	Open the System User Box (Bulletin Board, Relay, or Annotation User Box) to enable you to handle a document saved in the User Box or change the User Box setting. <ul style="list-style-type: none"> The Bulletin Board and Relay User Boxes are available when the optional Fax Kit is installed.
[Create System User Box]	Create a new Bulletin Board, Relay, or Annotation User Box.

9.6.7 Printer Settings



Item	Description
[Basic Setting]	Specify the default values of the printer.
[PCL Setting]	Specify the default values in the PCL mode.
[PS Setting]	Specify the default values in the PS mode.
[TIFF Setting]	Specify the paper to print TIFF images.
[XPS Settings]	Configure the XPS print settings.
[Interface Setting]	Specify the timeout period of the interface.
[Direct Print Settings]	Configure the settings to enable direct printing using PageScope Web Connection .
[Assign Account to Acquire Device Info]	Select whether to specify a password to obtain device information through the printer driver. If [ON] is selected, specify the password.

9.6.8 Store Address

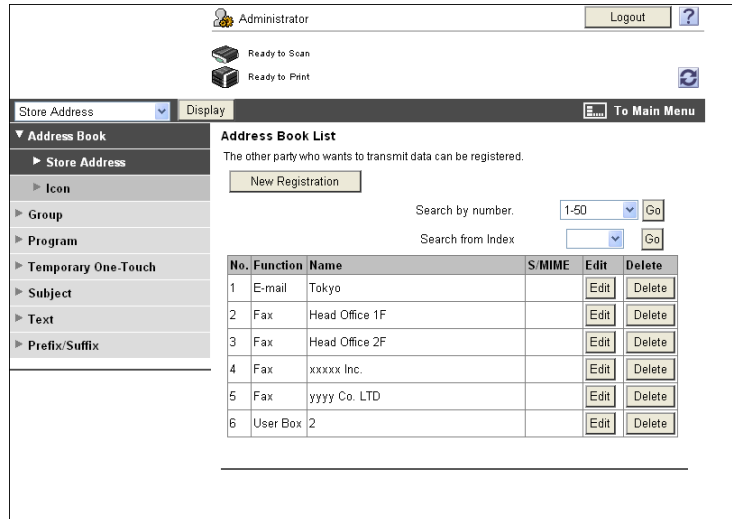

Item	Description
[Address Book]	Enables you to check the address book registered in this machine or to register and change an address.
[Group]	Enables you to check the group address book registered in this machine or to register and change an address.
[Program]	Enables you to check the program address book registered in this machine or to register and change an address.
[Temporary One-Touch]	Enables you to check the temporary program address book registered in this machine or to register and change an address.
[Subject]	Registers up to 10 subjects when sending E-mails.
[Text]	Registers up to 10 body messages to be used when sending E-mails.
[Application Registration]	Registers application settings and server addresses when using the applications such as RightFax Server registered in the external server. Registering applications and servers enables you to automatically connect to the server of the selected application. <ul style="list-style-type: none"> [Application Registration] is not displayed when the optional Fax Kit is installed.
[Prefix/Suffix]	Registers Prefix or Suffix to be added as destination information when E-mailing.

9.6.9 Fax Settings

The screenshot shows the 'Fax Settings' dialog box. At the top, it displays 'Administrator' with a 'Logout' button and a help icon. Below this, there are status indicators for 'Ready to Scan' and 'Ready to Print'. A 'Display' button and a 'To Main Menu' button are also present. The left sidebar lists various settings categories, with 'Header/Footer Position' selected. The main area shows the following settings:

- Header Position: Outside Body Text
- Print Receiver's Name: ON
- Footer Position: OFF

At the bottom right, there are 'OK' and 'Cancel' buttons.

Item	Description
[Header/Footer Position]	Configure the setting to print the sender or receiving information.
[Line Parameter Setting]	Specify the fax line such as Dialing Method.
[TX/RX Settings]	Configure the paper, User Box, and other settings for sending or receiving data.
[Function Setting]	Configure the fax settings for Memory RX or Network Fax.
[PBX Connection Setting]	Specify the outside line at PBX connection.
[Report Settings]	Configure the setting for a report, for example, Activity Report, to be output when sending or receiving data.
[Multi Line Settings]	Specify the parameters and functions of the extended line. <ul style="list-style-type: none"> This item is displayed when a line is extended.
[Network Fax Setting]	Configure the setting to use network fax.
[Header Information]	Registers sender information and fax number when sending data.

9.6.10 Wizard

Configure the settings according to the instructions shown in the window for items requiring multiple settings.

The available setting items are as follows.

- Configure the settings for sending a scanned document
- Configure the network print settings
- Restrict users using this machine

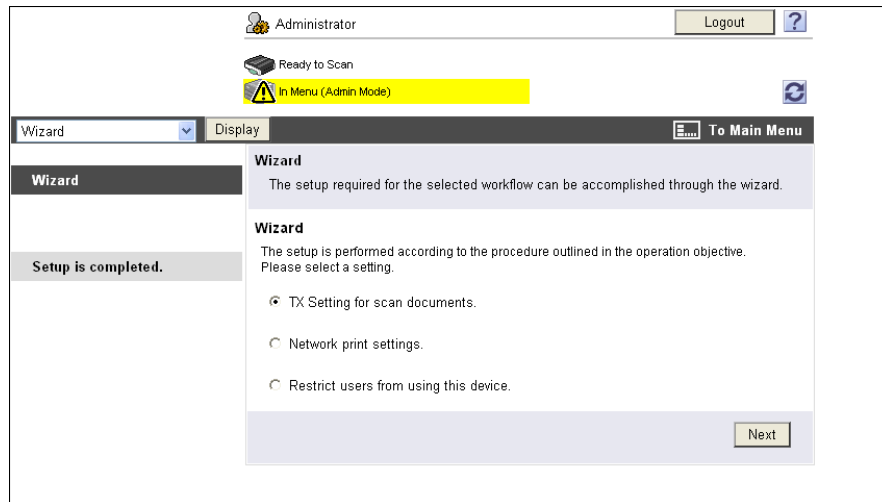

Reference

- As the setting procedure proceeds, its progress flow is displayed on the left.
- If setting is cancelled, you will return to the [Wizard] page after the items that were configured before cancellation have been applied.

10

Appendix

10 Appendix

10.1 Error message list

If an error message appears, perform the corresponding operation described below.

Message	Cause and remedy
Unable to connect to the network.	Make sure that the network cable is correctly connected. In addition, make sure that Network Settings in Administrator Settings have been correctly configured.
The address for the communication method cannot be selected since the number of addresses has exceeded the maximum allowed for broadcasting.	The number of destinations specified exceeds the number possible for a broadcast transmission. Reduce the number of broadcast destinations, or send the transmission in multiple batches.
Document could not be saved in user box due to insufficient HDD capacity. Check log.	The hard disk is full. Delete unnecessary data, and then try saving the data again.
The number of registered user boxes has reached the max. allowance.	The number of User Boxes that can be registered has reached the maximum number possible. Delete unnecessary User Boxes, and then try registering new boxes again.
The number of documents saved in the User Box has reached its maximum.	The number of documents that can be saved in a User Box has reached the maximum number possible. Delete unnecessary documents, and then try saving the document again.
The number of programmed jobs has reached the max. allowance. Wait until a programmed job is completed.	The number of jobs that can be programmed has reached the maximum number possible. Wait until a job has been completed, or delete a current job.



Reference

For details on the network settings, refer to [User's Guide Network Administrator].

10.2 Glossary

Term	Description
10Base-T/100Base-TX/1000Base-T	A set of specifications under the Ethernet standards. Those cables that consist of twisted copper wire pairs are used. The transmission speed of 10Base-T is 10 Mbps, of 100Base-TX is 100 Mbps, and of 1000Base-T is 1000 Mbps.
Adobe® Flash®	Software or its file format developed by Adobe Systems Inc. (formerly by Macromedia, Inc.), used to create a content by compiling vector-graphic animations and sounds. The software allows handling interactive contents using keyboard or mouse. The files can be kept relatively compact and accessed from a Web browser with dedicated plug-in software.
Anonymous FTP	While normal FTP sites are protected by an account name and password, this type of FTP site can be used by anyone without a password by simply entering anonymous as the account name.
Authentication & print	A function that allows you to print the job sent from the printer driver during user authentication.
Auto IP	A function to obtain an IP address automatically. If one fails to get an IP address via DHCP, the auto IP gets an IP address from the space of "169.254.0.0".
bit	The abbreviation for binary digit. The smallest unit of information (data quantity) handled by a computer or printer. A bit uses only a 0 or a 1 to indicate data.
Bitmap Font	A font using a collection of dots to present characters. Jagged edges are conspicuous for the larger size Bitmap Font characters.
BMP	The abbreviation for bitmap. This is a file format for saving image data. (The file extension is ".bmp".) Commonly used on Windows platforms. BMP covers the color depth from monochrome (2 values) to full color (16,777,216 colors). BMP images are not suitable for compressed storage.
Byte	A byte indicates a unit of information (data quantity) handled by a computer or printer. A byte consists of eight bits.
Compact PDF	A compression method for minimizing the data size using the PDF format, used for digitalizing color documents. Compact PDF allows high compression performance by identifying the text and image regions, and applying the resolution and compression method optimized for each region. The compact PDF method can be selected in this machine when using the scanning function to digitalize documents.
Contrast	The difference in intensity between the light and dark parts of the image (light/dark variation). "Low contrast" indicates an image with little light/dark variation, while "High contrast" an image with large light/dark variation.
Default	An initial setting. The settings selected in advance and enabled when the machine is turned on, or the settings selected in advance and enabled when the function is activated.
Default Gateway	A device, such as a computer or router, used as a "gateway" to access computers on different LANs.
Density	The amount of density of an image.
Density Compensation	A color tone correction function used for output devices such as printers and displays.
DHCP	The acronym for Dynamic Host Configuration Protocol. used for a client computer on the TCP/IP network to load network configuration automatically from a server. Just using a DHCP server to centrally manage IP addresses of the DHCP clients enables you to construct a network without IP address conflicts or other troubles.
Dither	A method of presenting the quasi-shading of gray using black and white colors. This method is easier to process than error diffusion, but may stir some unevenness on the image.
DNS	The acronym for Domain Name System. DNS allows for obtaining the IP address corresponding to a host name in network environments. This system enables a user to access other computers on the network by specifying host names instead of elusive and non-intuitive IP addresses.

Term	Description
DPI (dpi)	The acronym for Dots Per Inch. A unit of resolution used for printers and scanners. This indicates the number of dots used to represent an inch. The higher this value, the higher the resolution.
Driver	Software that works as a bridge between a computer and a peripheral device.
Ethernet	A standard for LAN transmission lines.
File extension	Characters added to a file name for the recognition of the file format. The file extension is added after a dot of a file name, for example, ".bmp" or ".jpg".
FTP	The acronym for File Transfer Protocol. This is a protocol used for transferring files via the Internet, an intranet or other TCP/IP network.
Gradation	The shading levels of an image. Larger number of the levels can reproduce smoother transition of the shading.
Gray scale	A form of presenting monochrome image by using the gradation information shifting from black to white.
Halftone	A method for presenting the shading of an image by using different sizes of black and white dots.
Hard disk	A large capacity storage device for storing data. The data is retained even after the power is turned off.
HTTP	The acronym for HyperText Transfer Protocol. This is a protocol used to send or receive data between a Web server and a client (such as a Web browser). HTTP can exchange files such as images, sounds, and movies that are associated with documents, including their presentation formats and other information.
Install	To install hardware, operating systems, applications, printer drivers, or other software on to a computer.
IP Address	An address or a code used to identify an individual network device on the Internet. IPv4 (Internet Protocol version 4), a protocol widely used today, adopts a 32-bit number for an IP address separated into four sections. An example of an IPv4 IP address is: 192.168.1.10. On the other hand, IPv6 (Internet Protocol version 6), the next generation protocol, adopts 128-bit IP addresses. An IP address is assigned to every computer or other device connected to the Internet.
JPEG	The acronym for Joint Photographic Experts Group, One of the file formats used to save image data. (The file extension is ".jpg".) The compression ratio is generally 1/10 to 1/100. JPEG is an effective method to compress photographs and other natural images.
Kerberos	A network authentication system used for Windows 2000 or later, used as the Active Directory authentication. Kerberos arranges an authentic site within the network to provide two-phase authentication processes of users login and the use of network resources, allowing users to be securely and efficiently authenticated.
LAN	The acronym for Local Area Network. This is a network constructed by connecting computers on the same floor, in the same building, or in neighboring buildings.
LDAP	The acronym for Lightweight Directory Access Protocol, a protocol used to access a database that can manage E-mail addresses and environmental information of network users on the Internet, intranet, or other TCP/IP network.
Memory	A storage device used for storing data temporarily. Some types of memory retain data even after the power is turned off, while others not.
Multi Page TIFF	A TIFF file that contains multiple pages.
OS	The acronym for Operating System. This is base software used to control the system of a computer. Windows, MacOS, or UNIX is an OS.
PASV	The abbreviation for PASSive, a mode used to connect to an FTP server from within a firewall. If this mode is not selected, the firewall regards the access as unauthorized and blocks the connection, disabling any file transmission.
PDF	The acronym for Portable Document Format. This is an electronically formatted document with file extension of ".pdf". PDF is based on the PostScript format. You can use the free Adobe Reader software to view PDF documents.
Pixel	The smallest constitutional unit of an image. Pixel indicates an image pixel, the smallest constitutional unit of an image.

Term	Description
Plug and play	A mechanism used to immediately detect a peripheral device when it is plugged into a computer, and search for an appropriate driver automatically, so that the device becomes operable.
Port Number	A number used to identify the transmission port assigned to each process running on a computer on the network. The same port cannot be used by multiple processes.
PPI	The acronym for Pixels Per Inch, Measuring unit for resolution, particularly for monitors and scanners. It indicates how many pixels are contained per inch.
Preview	A function allowing you to view an image before being processed for printing or scanning.
Print job	A print request transmitted from a computer to a printing device.
Printer driver	Software that works as a bridge between a computer and a printer.
Property	Attribute information. When using a printer driver, various functions can be specified in the file properties. By using properties of a file, you can check the attribute information about the file.
Protocol	A rule enabling a computer to communicate with other computers or peripherals.
Proxy server	A server that is installed to act as an intermediary connection between each client and different servers to effectively ensure security over the entire system for Internet connections.
Resolution	The resolution value indicates how much detail of an object can be reproduced precisely on an image or a print matter.
Scanning	The reading of an image in scanner operation by moving aligned image sensors step by step. The direction of moving image sensors is called the main scanning direction, and the direction of image sensors alignment is called the sub-scanning direction.
Screen frequency	The density of dots used to create the image.
Single-page TIFF	A TIFF file that contains only a single page.
SMB	The acronym for Server Message Block. This is a protocol for sharing files and printers mainly over the Windows network.
SSL/TLS	The acronym for Secure Socket Layer/Transport Layer Security, an encoding method used to securely transmit data between the Web server and a browser.
Subnet mask	A value used to divide a TCP/IP network into small networks (subnetworks). This is used to identify how many higher-order bits of an IP address are used for the network address.
TCP/IP	The acronym for Transmission Control Protocol/Internet Protocol. It is a de facto standard protocol widely used for the Internet. An IP address is used to identify each network device.
Thumbnail	A function of displaying the content of an image or document file by a small image (image displayed when the file is opened).
TIFF	The acronym for Tagged Image File Format, One of the file formats used for saving image data. (The file extension is ".tif".) By using the "tag" indicating the data type, information for various image formats can be saved in a single image data.
TWAIN	An interface standard defined for between imaging devices including scanners and digital cameras and applications including graphics software. To use a TWAIN compatible device, a relevant TWAIN driver is required.
Uninstallation	To delete software installed on a computer.
USB	The acronym for Universal Serial Bus. This is a general-purpose interface defined for connecting a mouse, printer, and other devices with a computer.
Web browser	Software used to view Web pages. Typical Web browsers include Internet Explorer and Netscape Navigator.

11 **Index**

11 Index

11.1 Index by item

Numerics

1-sided/2-sided 7-9

A

Accessing 9-3

Address book - search 7-39

Address search 7-47

Address type 7-39

Administrator settings 8-4, 8-15

Allow/restrict user box 8-23

Annotation user box 6-3, 7-89, 8-17

Application 7-63, 7-71

Application - book copy 6-16

Application - frame erase 6-15

Apply stamps 8-32

Auto delete secure document 8-21

B

Background removal 6-14

Basic - color 6-12

Basic - density 6-12

Basic - file type 6-8

Basic - original type 6-6

Basic - resolution 6-7

Basic - simplex/duplex 6-7

Bind TX 7-36

Binding position 6-17

Body 7-58

Book copy method 6-16

Book erase - center erase 6-17

Book erase - frame erase 6-16

Bulletin board user box 7-83, 8-7

C

Cellular phone/PDA setting 8-12, 8-25

Chapters 7-21

Check dest. & send 7-56

Check HDD capacity 8-27

Check printing preferences 7-106

Check/change temporarily 7-32

City 7-48

Color 7-10, 7-69

Combine 7-7, 7-14

Communication method settings 7-60

Communication settings 7-55

Company name 7-49

Continuous print 7-16

Control panel 3-2

Copies 7-9

Copy 7-67

Copy guard type 7-27

Copy protect 7-25

Cover sheet 7-19

Creating a user box 8-6, 8-16

Custom display settings 8-10

Custom size 6-13

Customize 9-22

D

Date/time 7-22

Default tab 8-10

Delete empty user box(es) (Administrator settings) 8-7

Delete page 7-72

Delete secure print documents 8-20

Delete unused user box 8-20

Deleting documents 7-66

Density 7-92

Department 7-49

Despeckle 6-20

Detail 3-10

Detail search 7-40, 7-59

Detail settings 7-26, 7-28, 7-29, 7-31, 7-45, 7-46, 7-82

Digital signature 7-62

Direct input 7-41, 7-59

Direct print 9-20

Direction settings - binding position 6-20

Direction settings - original direction 6-19

Displaying detailed information 7-70

Document delete time setting 8-24

Document details 7-70, 7-102

Document hold setting 8-22

Document name 7-57

Download 9-31

E

ECM OFF 7-56

Edit document 7-72

Edit name 7-66

E-mail 7-42

E-mail addr. 7-48

E-mail encryption 7-62

E-mail settings 7-57

Encrypted PDF data 7-101

Encrypted PDF delete time 8-21

Encryption 6-9, 7-51

Encryption - detail settings 6-9, 7-51

Entering the PIN code 7-106

Error message list 10-3

External memory *4-11, 4-15, 6-3, 7-100*
 External memory function settings *8-23*

F

Fax *7-42*
 Fax header settings *7-62*
 Fax number *7-48*
 Fax retransmit user box *7-95*
 Fax settings *9-45*
 F-code transmission *7-61*
 File list *9-24*
 File name *2-10*
 File path *7-44, 7-45, 7-46, 7-101*
 File type *6-8, 7-50, 7-69*
 Filing *4-17*
 Filing settings *7-65*
 Finishing *7-10*
 First name *7-48*
 Fold/bind *7-12*
 Format HDD *8-31*
 From *7-58*
 FTP *7-45*

G

Glossary *10-4*
 Group *7-11*

H

HDD encryption setting *8-31*
 HDD lock password *8-30*
 HDD settings *8-27*
 Header/footer *7-31*
 Host name *7-44, 7-45, 7-46*

I

Icons *3-4*
 ID & print delete after print setting *8-24*
 ID & print delete time *8-22*
 ID & print settings *8-25*
 ID & print user box *7-98*
 Image adjustment *6-14*
 Image shift - change back shift *7-18*
 Index *7-40*
 Information *9-18*
 Insert sheet *7-20*
 Insert sheet setting *7-24*
 Internet fax *7-43*
 IP address fax *7-44*

J

Job *9-19*
 Job history *7-47*
 Job list *3-6*
 Job list - delete *3-6*
 Job list - job details *3-7*

L

Last name *7-48*
 LDAP search - advanced search *7-48*
 LDAP search - search *7-48*
 Left panel *3-5*
 Line setting *7-55*
 Link file error notification *8-11*

M

Maintenance *9-37*
 Maximum number of user boxes *8-19*
 Memory RX user box *7-88*
 Menu tree *1-7, 4-23, 8-3*
 Mobile/PDA *7-105*
 Move page *7-75*
 Move/copy *9-34*
 Moving documents *7-66*

N

Name *7-48*
 Network *9-41*
 New *7-80*
 Next destination *7-45, 7-46*
 Number type *7-93*

O

Offset *7-11*
 Online help *9-4*
 Operating environment *9-3*
 OR/AND/STARTS WITH/ENDS WITH *7-49*
 Organizing documents *2-6*
 Original settings *6-19*
 Outline PDF *6-11, 7-53*
 Overlay setting *7-34*
 Overseas TX *7-55*
 Overwrite *7-81*
 Overwrite all data *8-29*
 Overwrite Temporary Data *8-28*

P

Page configuration *9-16*
 Page margin *7-17*
 Page number *7-23*
 PageScope Web Connection *9-3*
 Paper *7-103*
 Password *7-44, 7-45, 7-46*
 Password encrypted PDF user box *7-97*
 Password transmission *7-61*
 PC (SMB) *7-44*
 Photo size *6-13*
 Polling TX user box *7-84*
 Position *7-26, 7-31*
 Preview *3-14, 3-15, 7-70*
 Preview/set range *7-77*
 Preview/specify by Input *7-77*
 Print *7-6, 7-7, 9-25*

Print - application 7-17
Print - basic 7-9, 7-102
Print position 7-93
Print/save 7-97
Printer settings 9-43
Printing 4-5, 4-15
Proxy server use 8-11
Punch 7-11
Punch - position setting 7-12

R

Receiver RX ability 7-43
Reference 7-45
Register overlay 7-79
Registered overlay 7-33
Relay user box 8-9
Resolution 7-49, 7-68
Rotate page 7-73

S

Save in external memory 7-67
Save in user box 7-104
Saving 4-3, 4-11
Saving documents 2-3, 6-3
Scan setting 6-11, 7-54
Scan settings 6-6
Scan size 6-13
Search options 7-41
Secondary field 7-92
Secure document user box 7-85
Security 9-39
Security details 8-27
Security print only 8-27
Select line 7-56
Send 7-35, 7-36, 9-28
Send & print 7-64
Sending 4-8
Separate scan 6-18
Setting for each purpose 9-46
Sharpness 6-15
Sheet/cover/chapter Insert 7-18
Shortcut key 8-10
Sort 7-11
Special original 6-19
Stamp 7-24
Stamp composition 7-53
Stamp element 7-92
Stamp repeat 7-30
Stamp settings 8-32
Stamp type 7-29
Stamp/composition 7-22
Standard size 6-13
Staple 7-11
Staple - position setting 7-11
Store address 9-21, 9-44

Subject 7-57
System settings 9-38
System user box 6-4

T

Timer transmission 7-60
Touch panel 3-4

U

URL notification setting 7-59
Use/file 7-3
Use/file - check job settings 3-12
Use/file - check job settings - check e-mail settings 3-14
Use/file - check job settings - communication settings 3-14
Use/file - check job settings - destination settings 3-13
Use/file - check job settings - document setting contents 3-13
Use/file - details 3-12
User authentication 2-8
User authentication/account track 9-40
User box administrator setting 8-26
User box setting 8-10, 8-20
User boxes 9-19, 9-42
User name 7-44, 7-45, 7-46
Using documents 2-4

V

V.34 OFF 7-56

W

Web browser cache 9-4
WebDAV 7-46

Z

Zoom 7-15

11.2 Index by button

Numerics

1-Sided 6-7
 2in1 7-14
 2-Sided 6-7
 4in1 7-14
 8in1 7-14

A

Address Type 7-39
 Advanced Search 7-48
 All Jobs 3-8, 3-9, 3-10, 3-11
 Allow/Restrict User Box 8-23
 Annotation User Box 7-89, 8-17
 Application 7-37
 Apply Stamps 8-32
 Auto 6-20
 Auto Color 6-12
 Auto Delete Secure Document 8-21

B

Back (Blank) 7-19
 Back (Copy) 7-19
 Background Pattern 7-26, 7-28, 7-29
 Background Removal 6-14
 Bind TX 7-35
 Binding Position 6-17, 6-20
 Black 6-12, 7-54
 Blank 7-21
 Body 7-58
 Book Copy 6-16
 Book Spread 6-16
 Bulletin Board User Box 7-83, 8-7

C

Center Erase 6-17
 Center Staple & Fold 7-12
 Change Pos./Delete 7-26, 7-31
 Chapter Paper 7-21
 Chapters 7-18
 Check HDD Capacity 8-27
 Check Job 3-5
 Check Job Set. 3-7, 3-8
 Check Job Settings 3-12
 Check/Change Temporarily 7-31
 City 7-48
 Color 6-12, 7-54, 7-82
 Combine 7-6, 7-7, 7-14
 Comm. List 3-9, 3-10, 3-11
 Communication Method Settings 7-60
 Communication Settings 7-37
 Compact PDF 6-8, 7-50
 Compact XPS 6-8, 7-50
 Company Name 7-49
 Compulsory Memory RX User Box 7-88

Continuous Print 7-8, 7-16
 Copied Paper 6-6
 Copy 7-20, 7-65, 7-67
 Copy Guard Pattern 7-28
 Copy Protect 7-22, 7-25
 Copy Protect Pattern 7-26
 Cover + 2-Sided 6-7
 Cover Sheet 7-18
 Custom Display Settings - User Box Setting 8-10
 Custom Size 6-13

D

Date/Time 7-22, 7-26, 7-27, 7-29, 7-30, 7-92, 8-18
 Default Tab 8-10
 Delete 3-6, 3-7, 3-8, 3-10, 3-11, 7-65, 7-87, 7-88, 7-94, 7-96, 7-97, 7-99
 Delete Secure Print Documents 8-20
 Delete Unused User Box 8-20
 Deleted Jobs 3-8, 3-9, 3-10, 3-11
 Deleting 7-66
 Density 6-12, 7-26, 7-31, 7-82, 7-92, 8-18
 Department 7-49
 Despeckle 6-20
 Detail 3-7, 3-9, 3-10, 3-11, 3-12
 Detail Search 7-40
 Detail Settings 6-9, 7-25, 7-26, 7-28, 7-29, 7-30, 7-31, 7-34, 7-45, 7-46, 7-82
 Detail View 7-4
 Digital Signature 7-62
 Display Name 7-34
 Do Not Print # 7-24
 Do Not Print Page Number 7-24
 Document Delete Time Setting 8-24
 Document Details 7-4, 7-65, 7-70, 7-71, 7-87, 7-88, 7-94, 7-102
 Document Hold Setting 8-22
 Document Name 6-5, 7-57
 Document Permissions 6-9, 7-51
 Document Settings 7-37
 Dot Matrix Original 6-6

E

ECM OFF 7-56
 Edit Document 7-71
 Edit Name 7-65, 7-66, 7-87, 7-88, 7-94
 E-mail 7-42
 E-mail Addr. 7-48
 E-mail Encryption 7-62
 E-Mail Settings 7-57
 Encrypted PDF Delete Time 8-21
 Encryption 6-9, 7-51
 Encryption Priority 8-28
 Existing Setting 7-15

External Memory 7-100
 External Memory Document Scan 8-23
 External Memory Function Settings 8-23

F

Fax 3-16, 7-42, 7-95
 Fax Header Settings 7-62
 Fax Number 7-48
 F-Code transmission 7-61
 File Path 7-44, 7-45, 7-46
 File Type 6-8, 7-50
 Finished Jobs 3-8, 3-9, 3-10, 3-11
 Finishing 7-7, 7-8
 First Name 7-48
 Fold/Bind 7-12
 Format HDD 8-31
 Forward 3-10
 Frame Erase 6-15, 6-16
 From 7-58
 Front (Blank) 7-19
 Front (Copy) 7-19
 Front + Back Cover 6-16
 Front Cover 6-16
 FTP 7-45
 Full Color 6-12, 7-54
 Full Size 7-15

G

Gray Scale 6-12, 7-54
 Group 7-37

H

Half-Fold 7-12
 HDD Encryption Setting 8-31
 HDD Lock Password 8-30
 HDD Settings 8-27
 Header/Footer 7-22, 7-31
 Host Name 7-44, 7-45, 7-46

I

ID & Print Delete after Print Setting 8-24
 ID & Print Delete Time 8-22
 ID & Print Settings 8-25
 ID & Print User Box 7-98
 Image 7-53
 Image Adjustment 6-14
 Image Details 7-34
 Image Shift 7-17
 Increase Priority 3-7
 Index 7-40, 8-6
 Insert Paper 7-20
 Insert Sheet 7-18
 Insert Sheet Setting 7-23
 Insert Type 7-20
 Internet Fax 7-43
 IP Address Fax 7-44

J

Job Details 3-7
 Job List 3-5, 3-6
 JPEG 6-8, 7-50

L

L1 3-8
 L2 3-8
 Last Name 7-48
 Left 6-20
 Line Setting 7-55
 Long Original 6-19

M

Manual 7-15
 Maximum Number of User Boxes 8-19
 Minimal 7-15
 Mixed Original 6-19
 Mode 1 8-28
 Mode 2 8-28
 Move 7-65
 Moving documents 7-66
 Multi Page 6-11, 7-54

N

Name 7-48
 New 7-80
 Next Destination 7-44, 7-45, 7-46
 Next Page 3-15, 3-16, 7-77
 Number Type 7-93, 8-18

O

OR/AND/STARTS WITH/ENDS WITH 7-49
 Original Direction 6-19
 Original Settings 6-5, 6-19
 Original Type 6-6
 Other 7-26, 7-27, 7-29, 7-30
 Overseas TX 7-55
 Overwrite 7-81
 Overwrite All Data 8-29
 Overwrite Priority 8-28

P

Page Margin 7-7, 7-8, 7-17
 Page Number 7-22, 7-23
 Page Separation 6-11, 7-54
 Paper 7-103
 Password 6-9, 7-44, 7-45, 7-46, 7-51, 8-6, 8-8, 8-17
 Password Copy Pattern 7-29
 Password Encrypted PDF User Box 7-97
 Password transmission 7-61
 Pattern Overwrite 7-26, 7-31
 PC (SMB) 7-44
 PDF 6-8, 7-50
 Photo 6-6

Photo Size *6-13*
 Polling TX User Box *7-84*
 Position *7-25, 7-26, 7-30, 7-31*
 Position Setting *7-11*
 Preset Stamp *7-26, 7-27, 7-29, 7-30*
 Prev. Page *3-15, 3-16, 7-77*
 Preview *3-5, 3-14, 7-70*
 Preview/Set Range *7-77*
 Preview/Specify by Input *7-77*
 Primary Field *8-18*
 Print *7-6, 7-99, 7-101*
 Print Document *8-23*
 Print on Back Cover only *7-24*
 Print on Front and Back Cover *7-24*
 Print page # *7-24*
 Print Position *7-22, 7-23, 7-25, 7-93, 8-18*
 Proof Print *7-95*
 Public, Personal, or Group User Box *8-6*

R

Receiver RX Ability *7-43*
 Redial *3-8, 3-10*
 Reference *7-45*
 Register Overlay *7-71, 7-79, 7-94*
 Registered Overlay *7-22, 7-33*
 Registered Stamp *7-26, 7-30*
 Relay Destination *8-9*
 Relay TX Password *8-9*
 Relay User Box *8-9*
 Release Held Job *3-7*
 Reset *7-4*
 Resolution *6-7, 7-49*

S

Save Document *7-4, 8-23*
 Scan *3-16*
 Scan Settings *6-5*
 Scan Size *6-13*
 Search *7-37, 7-39, 7-48*
 Secondary Field *7-92, 8-18*
 Secure Document User Box *7-85*
 Security Print Only *8-27*
 Select All *7-4*
 Send & Print *7-64*
 Separate Scan *6-18*
 Separation *6-16*
 Sharpness *6-15*
 Sheet/Cover/Chapter Insert *7-7*
 Shortcut key *8-10*
 Simplex/Duplex *6-7*
 Skip the Page(s) *7-24*
 Sort *7-20, 7-21*
 Stamp *7-22, 7-24*
 Stamp Composition *7-53*
 Stamp Element *7-92*

Stamp Repeat *7-22, 7-30*
 Stamp/Composition *7-7, 7-8, 7-63*
 Subject *7-57*

T

Text *6-6, 7-53*
 Text Color *7-25, 7-31*
 Text Details *7-22, 7-23, 7-32*
 Text Size *7-25, 7-26, 7-28, 7-29, 7-31*
 Text/Background Color *7-26, 7-28, 7-29*
 Text/Photo *6-6*
 Thumbnail View *7-4, 7-34*
 TIFF *6-8, 7-50*
 Timer transmission *7-60*
 Timer TX Job *3-8*
 Top *6-20*

U

URL Notification Setting *7-59*
 Use Existing Color Setting *7-54*
 User Box *6-5*
 User Box Administrator Setting *8-26*
 User Box Name *8-6, 8-8, 8-9, 8-17*
 User Box No *8-8, 8-9, 8-17*
 User Box No. *8-6*
 User Box Setting *8-20*
 User Name *7-44, 7-45, 7-46*

V

V.34 OFF *7-56*
 View Finishing *3-15, 3-16*

W

WebDAV *7-46*

X

XPS *6-8, 7-50*

Z

Z-Folded Original *6-19*
 Zoom *7-7, 7-15*